

AT MICROFICHE REFERENCE LIBRARY

A project of Volunteers in Asia

The Beekeeper's Handbook

by: Diana Sammataro and Alphonse Avitabile

Published by:

Charles Scribner's Sons
597 Fifth Avenue
New York, NY 10017 USA

Paper copies are \$ 7.95.

Available from:

Charles Scribner's Sons
597 Fifth Avenue
New York, NY 10017 USA

Reproduced by permission of Charles Scribner's
Sons.

Reproduction of this microfiche document in any
form is subject to the same restrictions as those
of the original document.

by Diana Sammataro and Alphonse Avitabile
Foreword by E. C. Martin

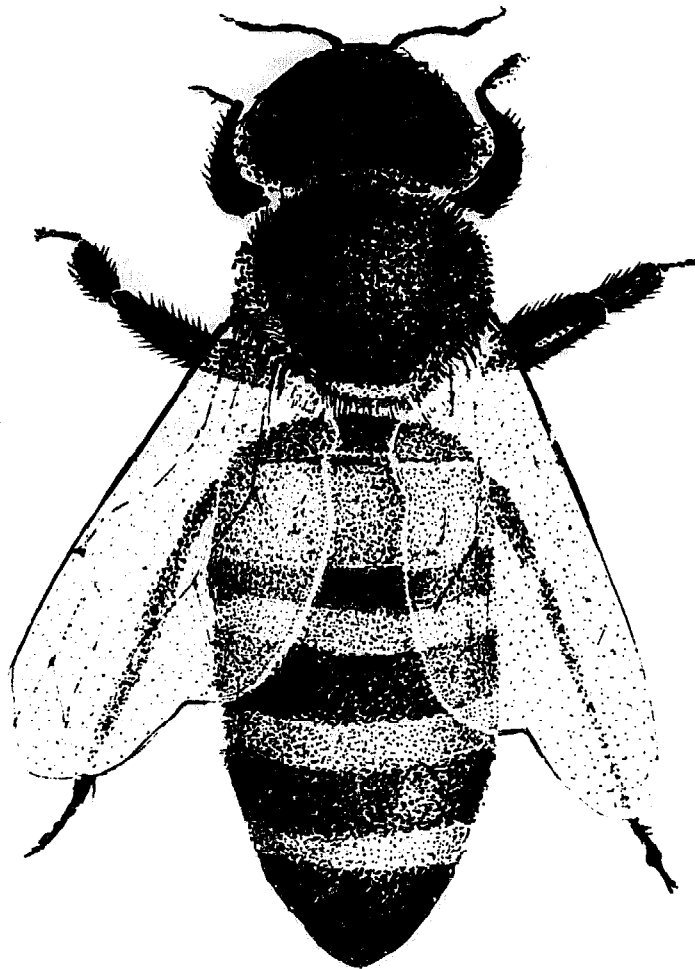

The Beekeeper's Handbook

by Diana Sammataro and Alphonse Avitabile

Foreword by E. C. Martin

Illustrations by Diana Sammataro and Jan Propst

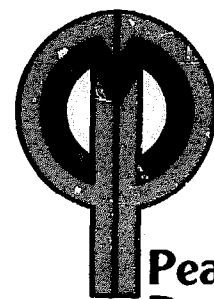

**Peach Mountain Press, Ltd.
Dexter, Michigan**

Acknowledgments

So many people, students, teachers, and relatives alike contributed so much to make this book possible that we could not possibly list them all. However, the following people are acknowledged for their physical, spiritual, intellectual, and financial support in the creation and production of this effort. We love you all for what you gave and are humbled when all we can say is *thank you*.

Special thanks to Linda Stafford for her skillful editing of the manuscript, to Jan Propst for her fine drawings, and Carol Conkey for preparing an excellent index.

Ruth Avitabile
Josephine Bologna
Ron Conkey
William Howison
John Kasinkas
Bob and Dorothy Kennedy
Paul and Lois LaRue
Dolly Ann Martin
John and Gwen Nystuen
Anthon Pedersen

Paul Propst
Jan Raad
Dick and Jinny Ryan
Joe and Nelva Sammataro
Margaret Santaro
Milton Savos
Kathryn Sedo
Dick and Chip Spear
Doug and Grace Truax

© 1978 by Diana Sammataro and
Alphonse Avitabile

All rights reserved

Published by Peach Mountain Press, Ltd.,
Dexter, Michigan

Library of Congress Catalog Card
No. 78-54266

ISBN 0-931850-00-2 cloth
ISBN 0-931850-01-0 paper

Manufactured in the United States
of America

Foreword

A steadily growing interest in beekeeping has been evident during the 1970s. This has been partly stimulated by increases in the price of honey during the 1970s and some people have started beekeeping with the idea that they could make a profit from it. But more have been caught up in what I think is a very commendable trend. They want to work in a garden to produce their own vegetables, to raise goats to produce their own milk, or keep bees to produce their very own delicious honey. This is part of a yearning to do something that brings us closer to nature, to get away from the machines and computers and the synthetic quality of much of modern life, to experience the thrill of producing something from the earth. Along with this has come an interest in preserving the many wild, beautiful, natural aspects of our environment, a feeling that these things are important if we are to maintain our world as a place worth living in.

Beginning beekeepers usually have to rely on literature to guide their progress in mastering the art and science of apiculture. Those who can get help from knowledgeable beekeepers are fortunate. There are hundreds of beekeeping books,

but there is an almost universal complaint that beginners' books are not sufficiently explicit. This book is designed basically for beginners. It will not only give you a good understanding of the life history and behavior of bees, but it also tells you how to manage bees, how to control their diseases, how to remove and process honey, and many other "how-to-do-it" aspects. It also discusses reasons, advantages, and disadvantages of carrying out major hive manipulations. This is good. It will cause you to think and ponder and more fully understand what beekeeping is all about. There is a good section on life history and behavior of bees, and don't underestimate the need to understand bees and their natural behavior if you are to learn how to manage them. Honey bees are still wild creatures, in spite of their long association with man. Much of beekeeping consists of modifying the natural behavior of bees to accomplish our purposes.

Beginners, naturally, want to be told precisely what to do at different times of the year, and this book attempts to provide this information in a concise and accurate way. Keep in mind, however, that you do not become an accomplished beekeeper until you can

open a hive, examine a few combs, diagnose the needs of the colony, and perform the appropriate manipulations needed to keep the colony progressing towards maximum production. When that day arrives, you will be a beekeeper. Beekeeping isn't simple, but if it intrigues you, stay with it. It will take three or four seasons before you feel that you are definitely mastering the art. Even the most experienced beekeepers continue to learn new ways each season.

If this book starts you securely on your way, it will be one of the important investments of your life. As you progress, join a beekeepers association, subscribe to one or two bee journals, continue to build your beekeeping library, and become part of a great fraternity.

E. C. Martin
Agricultural Research Service
Beltsville, Maryland

Contents

Introduction	1
What You Should Know First	2
Understanding Bees	3
Equipment and Beekeeping Supplies	18
Before the Bees Arrive	24
Obtaining Bees	28
Working with Bees	30
Starting Bees from Packages	38
Feeding Bees	44
General Seasonal Management	53
Special Management Problems	68
Products of the Hive	93
Bee Pests and Diseases	99
Bee Plants	109
Appendices	
A Bee Sting Reaction Physiology	112
B Anatomy of the Honey Bee	114
C Observation Hives	118
D Basic Hive Parts	119
References	120
Index	129

Introduction

Beekeeping is an interesting and rewarding activity for those with a love of nature, the fascination with the unique social organization of bees, or a taste for honey.

This handbook is designed to help people who intend to keep honey bees, as well as those who already have them and are in need of a ready guide on various beekeeping techniques. It is designed to help both the new or experienced beekeeper in setting up or reorganizing an apiary, or bee yard, and in improving their style of working with bees. This book can also serve as a quick outline on colony management operations. The text presents the key elements in beekeeping—outlining all of the major options available to the beekeeper. It lists advantages and disadvantages of each important technique. It is extensively cross-referenced to point the reader to more detailed information when that is necessary.

Numerous diagrams and illustrations illuminate the descriptions given in the text and help to acquaint the reader with various equipment, beekeeping operations, and the like. Space has been provided so that readers can keep notes on their own successes and failures.

An extensive reference section lists not only the basic beekeeping books but the pamphlets, supply houses, organizations, and such which can be of immense value to all who keep bees.

While considered by some to be the "gentle art," beekeeping in reality can be physically demanding and strenuous. The typical picture of a veiled beekeeper, standing beside the hive with smoker in hand, does not depict the aching back, sweating brow, smoke-filled eyes, or painful stings. This handbook is intended to maximize the more interesting and enjoyable aspects of the art.



What You Should Know First

LEGAL REQUIREMENTS

All states have some laws that pertain to keeping honey bees and registering hives containing bees. Some city and state laws limit the number of *hives* (the wooden boxes that colonies of bees live in) in urban areas. Since bees can be declared a nuisance in some cities, local laws must be studied before an *apiary* is established. Most states have an Apiary Inspection Law developed to aid the beekeeper by providing statutory means for controlling and eradicating American foulbrood, once the most destructive of bee diseases. The law's general requirements are:

- All beekeepers must register hives containing honey bees with their state's department of agriculture.
- The director of agriculture and appointed deputies have the right to inspect, treat, quarantine, disinfect, and/or destroy any diseased hives.
- Transportation of bees and equipment must be certified by the bee inspector or other designated state official.
- All beekeepers shall have bee colonies in hives containing moveable frames.

- Exposing combs and equipment infected with American foulbrood is illegal.
- Penalties are provided for violations of these apiary inspection laws.

For specific legal requirements, check your state department of agriculture's Apiary Inspection Law (see *REFERENCES: Management of Bee Colonies*).

BEE STING REACTIONS

An important question that beekeepers must consider is their individual response to bee stings. Although most beekeepers become immune to bee stings after a few years, some individuals may develop an allergy to bee venom.

Reaction patterns vary among individuals, but there are two types of reactions—the *local* reaction and the *systemic* reaction, both of which are accompanied by some pain at the sting site.

In the first, a localized swelling occurs, like a mosquito bite, which is red and itchy and which usually lasts a few days. The *systemic* or general reaction, on the other hand, means that the entire body is reacting to the venom proteins.

Signs that indicate this more dangerous reaction are itching all over the body (hives), breathing difficulty, sneezing, or loss of consciousness. This type of reaction occurs when the body is allergic to the bee venom and, if not treated, could be fatal.

People generally develop either an immunity *or* an allergy to bee venom over time and repeated exposure to the poison. The individual's unique body chemistry will react in its characteristic way. If there is ever any question about whether one is developing an allergy, a physician or local allergy clinic should be consulted immediately!

Detailed information on the treatment of bee stings is included in the section on *HANDLING BEES*; the physiology of bee sting reactions is shown in *APPENDIX A*.

Understanding Bees

BEE ANCESTORS

The probable ancestors of the Order Hymenoptera, to which honey bees belong, evolved some 200 million years ago. Fossil insects preserved in Permian rock, dating from the close of the Paleozoic era, display Hymenopteran-like structures, including the membranous wings and the ant-like waists. Approximately 50 million years later, in the middle of the Mesozoic era, the Hymenopterans were firmly established in the fossil records. By late Mesozoic, there was also abundant plant life, including some flower-bearing species. It wasn't until 60 million years ago, the Tertiary period, that the stinging Hymenoptera became common; the land by this time was dominated by the flowering plants or angiosperms.

During the vast periods of time that followed, the flowering plants became more specialized and more dependent on motile pollinators. Insect pollinators like the bees (Apidae) were very important; the bees and the plants they pollinated each evolved structures to their mutual benefit as a result of their interdependence. The plants became more attractive to the bees in shape, color, and odor. In their turn, the bees developed hairy bodies to trap the pollen of flowers, inflatable sacs to carry away floral nectars, and a highly structured social order. Such an evolved social organization, along with a defense and communication system, has permitted these insects to efficiently exploit the most rewarding of floral sources. Among the members of the Apidae Family, one of the most valuable to man is the honey bee.

The placement of the honey bee in the Animal Kingdom is:

Phylum: Arthropoda (many-jointed, segmented, chitinous invertebrates)

Class: Insecta

Order: Hymenoptera (membranous wings)

Superfamily: Apoidea

Family: Apidae (nine members of this family are native to the U.S.)

Tribe: Apini

Genus: *Apis* (bee, native of the old world)

Species: *mellifera* (honey-bearing)

EVOLUTION OF SOCIAL STRUCTURE

Most insects are solitary creatures—they neither live together in communities nor share the labors of raising their young. Among the insects that do live in communities, the most noted are the ants, termites, wasps, and bees. The social structure defines the degree of community living, and the true social insects—those which are highly specialized—are ants, termites, and honey bees.

The sophistication of the social structures of honey bees is indicated by a number of characteristics, for example:

- longevity of the female parent (queen) co-existing with her offspring
- progressive feeding of food to the young, instead of mass-feeding
- division of labor; queen lays eggs, sterile female workers perform other functions
- nest and shelter construction, storage of food
- swarming as a reproductive process
- perennial nature of colony
- communication among members of the colony

Honey bees can be described as a *eusocial* community, consisting of a mother (queen), and daughters (sterile workers), overlapping at least two generations. Since hornet and wasp colonies, for example, do not overwinter as do honey bees they are termed semi-social insects.

RACES OF BEES

General

The races of honey bees (*Apis mellifera*) can be divided into three groups: the European, Oriental, and African races. The European race can be further divided into four groups: Dark, Italian, Carniolan, and Caucasian bees.

The Dark bees were first brought across the Atlantic by the early American colonists (about 1630). Over two centuries later (1859) the first Italian queens were imported to America. This variety was quickly recognized as superior to the German Dark bee, and today the Italian honey bee is the most widely distributed bee in the Western Hemisphere.

The other two European races have also been brought to the United States and, with the Italian bee, are crossbred, interbred, and inbred for disease resistance, hardiness, and gentleness.

Importation of honey bees into the United States was halted in 1922 because of the danger of introducing bee diseases which did not already exist here.

South America had no such restrictions when the African honey bee (*Apis mellifera adansonii*) was introduced there. The volatile hybrid—known as the Africanized Kerr Strain or Brazilian bee (and labeled the Killer Bee by the press)—may eventually be bred down and become gentler. So far, there is little scientific correlation between temper and honey production.

While the most common honey bee

in America is the Italian, the researcher or the hobbyist beekeeper may be interested in experimenting with some other bee races. Since uncontrolled crossbreeding of races could result in inferior queens, it is prudent to maintain only one race of bees in any one apiary.

A general breakdown of the races of honey bees now used in the United States (capsulized from the chapter on "Races of Bees," by F. Ruttner in the *Hive and the Honey Bee*, ed. by Dadant and Sons, Hamilton, Illinois, 1975), is shown in this section:

Italian Honey Bee (*Apis mellifera ligustica* Spin):

The Italians are yellow with dark brown bands on the abdomen; "goldens" have five bands, the "leathers" have three bands.

Advantages:

- good brood rearing habits
- hardy
- lighter color makes queen easy to locate
- moderate tendency to swarm
- moderate propolizers
- generally productive and gentle
- common and easy to obtain

Disadvantages:

- poor orientation
- not as gentle as other races
- tendency to rob weaker hives
- can be susceptible to many diseases

Caucasian Honey Bee (*Apis mellifera caucasica* Gorb):

Caucasian bees are black with gray bands; they were introduced from Russia.

Advantages:

- gentle and hardy
- have the longest tongue of the three races and can thus use more species of flowers
- little tendency to swarm
- forage at lower temperatures and earlier in the day

Disadvantages:

- can sting persistently when aroused
- tend to propolize or "bee glue" heavily
- late starters in spring brood rearing

Carniolan Honey Bee (*Apis mellifera carnica* Pollmann):

Carniolans are grayer than the Italians, with black bands; they are originally from Yugoslavia.

Advantages:

- gentlest of the three races
- few brood diseases
- economic honey consumers
- little robbing instinct
- very white wax and honey cappings
- low propolizers

Disadvantages:

- tendency to swarm
- hard to obtain
- dark queen difficult to locate

Hybrid Bees

In addition to these races of bees there are hybrid bees which can be crosses between races of bees or between selected strains within a race. Some common hybrids are Starline (inbred Italians), Midnite (inbred Caucasians), and Mraz (select strain Italians).

Advantages:

- better honey producers
- gentler
- hardier
- can be disease resistant

Disadvantages:

- offspring queens from hybrid mother may bear little resemblance to the original queen
- requeening every other year may be necessary to insure hybrid queen is laying and will not be superseded

BEE BEHAVIOR AND COLONY LIFE

A general knowledge of bee biology will enable the beekeeper to understand and, to some extent, manage the many activities of honey bees. Such information will aid the beekeeper in interpreting yearly cycles, signs of swarm preparation, queenlessness, failing or unmated queens, the presence of disease, and the behavior of bees under such circumstances.

There are three different types of honey bees in a colony, and the beekeeper must learn to recognize them: the *queen*, the infertile female *workers*, and the male bees or *drones*.

The queen, under normal conditions, is responsible for laying all the eggs for the colony and, through the release of chemical signals called *queen substances* or *pheromones*, can exert marked influence on the behavior of the workers and the drones. The drones are the male bees that mate with virgin or *newly mated queens* to provide queens with the semen needed to lay the fertilized eggs. Bee colonies are usually *monogynous*, having only one egg producer—the queen.

ANATOMY

The honey bee, like most insects, has three main body parts: a head, a thorax, and an abdomen (see illus.). Located on the head are five eyes (two compound and three simple ones), the antennae, and the feeding structures like the tongue (proboscis) and the jaws (mandibles).

The thorax, or middle section of the bee, contains the muscles which control the two pairs of wings; other muscles control the three pairs of legs. The legs are the specialized structures which assist the bee in cleaning itself and in collecting and carrying pollen. The armor-plated thorax is perforated with three pairs of holes, called spiracles, which are part of the breathing or respiratory system.

The abdomen is the longest part of the bee. It too is armor-plated with hard scale-like segments and is also perforated with seven more pairs of spiracles. The worker bee's sting is located on the tip of the abdomen. The wax secreting glands, on the underside of the abdomen, and the scent gland, just above the sting, are important abdominal glands. The queen's abdomen contains, among other things, ovaries for egg production, a storage sac for drone semen, and a sting but no wax glands. More detailed information on the digestive and glandular anatomy of the honey bee is included in *APPENDIX B*.

External Anatomy of a Worker Bee

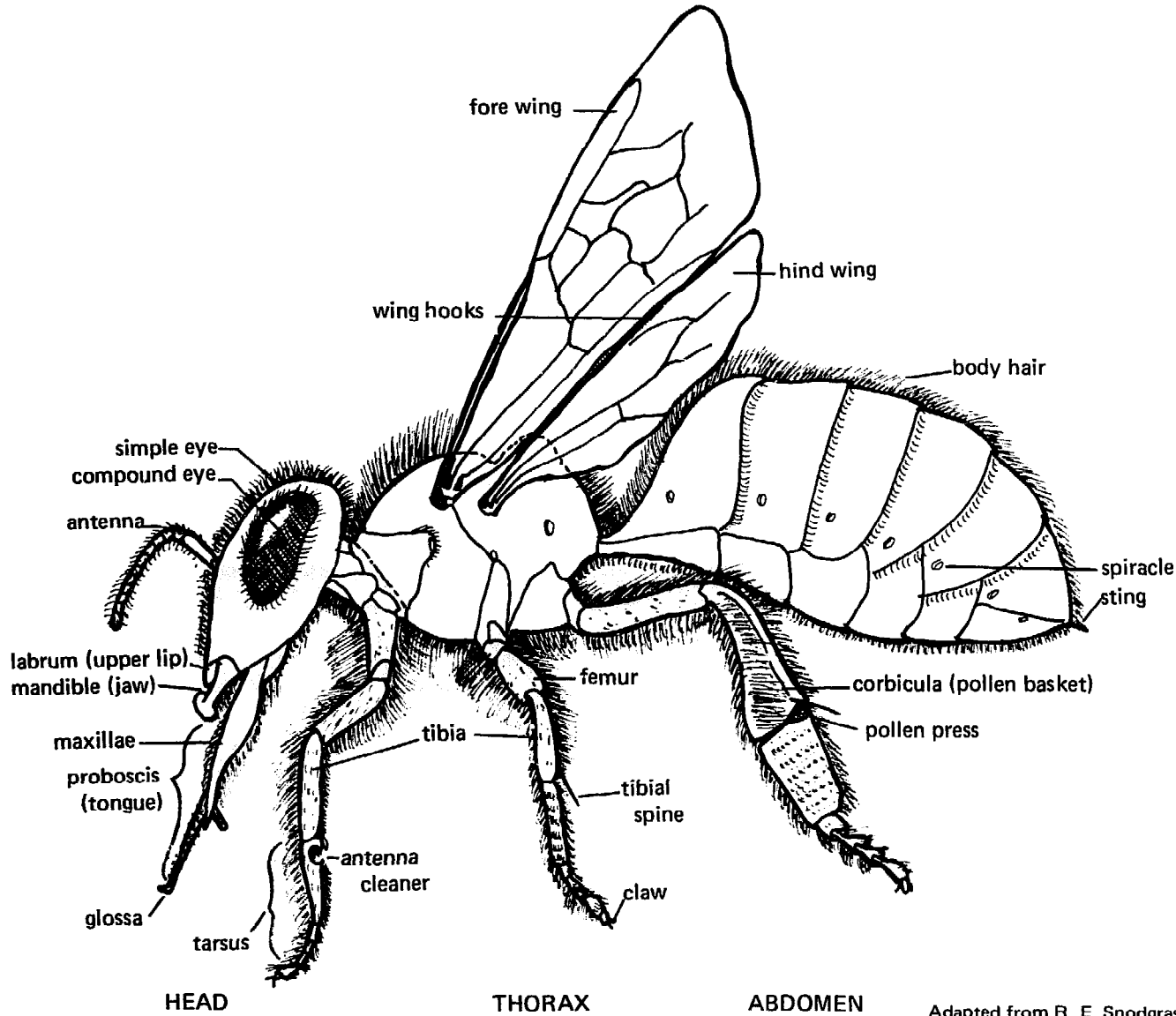

Adapted from R. E. Snodgrass: *Anatomy of the Honeybee*. Copyright © 1956 by Cornell University. Used by permission of Cornell University Press.

THE STING

Stinging insects belong to the Order Hymenoptera which includes both social and solitary bees and wasps. The more aggressive species of stinging insects are the hornets and the yellow jackets (both of the Vespidae Family); less aggressive are the bumble bees (Bombidae) and the honey bees (Apidae).

The venoms of these insects are not chemically alike. Thus, a beekeeper who is allergic to yellow jacket venom will not necessarily develop an allergy to honey bee venom or the venom of other stinging insects.

The newcomer to beekeeping should find it interesting that drone bees have no stinging structure, and that queens generally use their stings only to dispatch rival queens.

The stinging mechanism is a modification of the egg-laying equipment (or ovipositor) of female insects. The entire structure consists of an acid gland, an alkali gland, and a poison sac; the venom is a mixture of the contents of these glands.

The barbed lancets of the sting catch in the victim's skin and, as the bee pulls away, the poison sac attached to the sting apparatus is ripped out of the bee's body. Pumps near the base of the poison sac force more venom into the wound for several minutes. To minimize the amount of venom received, it is important to promptly remove the sting by scraping or flicking it off with a fingernail, *not* by pulling it out.

THE WORKER

The most numerous members of a bee colony are the workers, reaching a peak population of 40,000 or more by midsummer in a normal hive. The workers are smaller than the drones and have a shorter abdomen than the queen. The eggs from which workers and queens emerge are fertilized; drone eggs are not.

The eggs of worker bees hatch in three days; after hatching, they are first lavishly or mass-fed a high-protein substance called *royal jelly* (produced by the hypopharyngeal glands of adult workers) for a few days. Beginning on the fourth day these larvae are fed, as needed, with a mixture of honey and pollen. The switch from a royal jelly diet to one of pollen and honey appears to be responsible for the differentiation of larvae so fed into worker bees; similar larvae which are fed royal jelly throughout their larval life develop into queens.

After six days of feeding, the openings of the cells containing the larvae are capped over with a slightly convex wax cover. Inside the capped cell, the larva begins to spin a cocoon initiating the pupal stage; 12 days later, an adult worker bee chews its way from beneath the capping and begins the first of many tasks which she will perform *during* her life span.

The worker bee's age and the needs of the colony dictate the work she is to do. Generally, workers from one to three weeks of age remain within the hive. There they:

- rest
- feed and clean larvae and their cells
- tend the queen (feed, groom, help spread queen pheromones)
- clean the cells and the hive
- secrete wax
- build new comb and cap cells containing honey, pollen, and brood
- guard the entrance and other areas of the hive
- patrol the hive, look for intruders
- help to heat or cool the hive, as needed
- accept nectar from foragers; store and cure it
- pack pollen
- take brief orientation flights to familiarize themselves with landmarks near the hive, also called play flights

After about three weeks of hive duties, the glands that produce the larval food and wax have begun to atrophy. These workers then move away from the warm *broodnest* (where the eggs, larvae, and pupae are) onto broodless combs. Here they come in contact with returning foragers and are eventually recruited to food sources.

As foragers, they will usually collect one of the following items: honeydew, pollen, nectar, water, or propolis. Foraging activities take a heavy toll on workers and

most of them die after about three weeks of outside duties. During the winter, however, most workers survive for several months.

Development of a Honey Bee

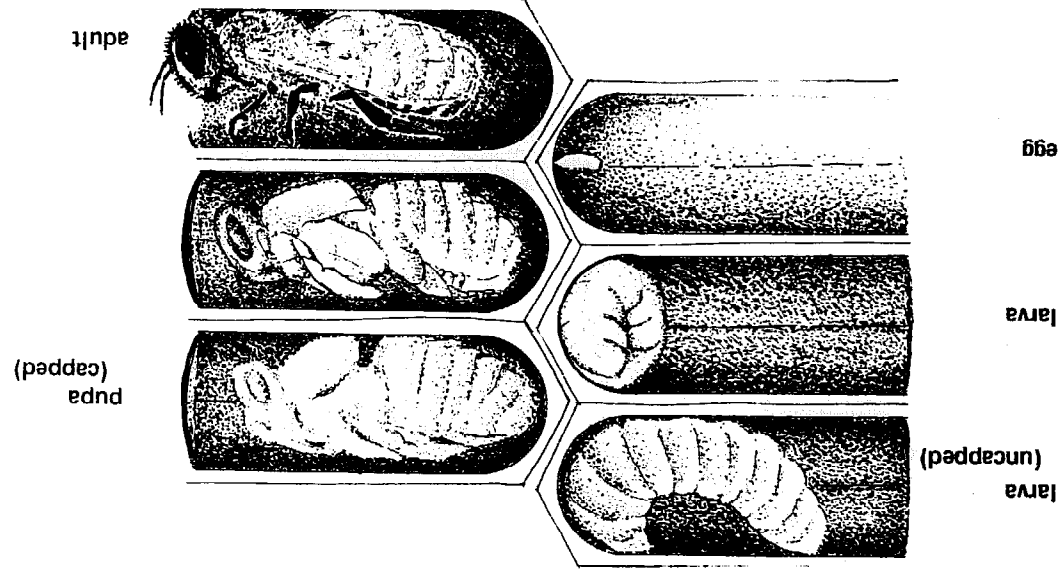

	egg	larva	pupa	total	adult life
Queen (fertilized)	3 days	5.5 days	7.5 days	16 days	2-5 years
Worker (fertilized)	3 days	6.0 days	12.0 days	21 days	6 weeks (summer)
Drone, (unfertilized)	3 days	6.5 days	14.5 days	24 days	8 weeks

Time between metamorphic stages, at 93° F (33.9° C)

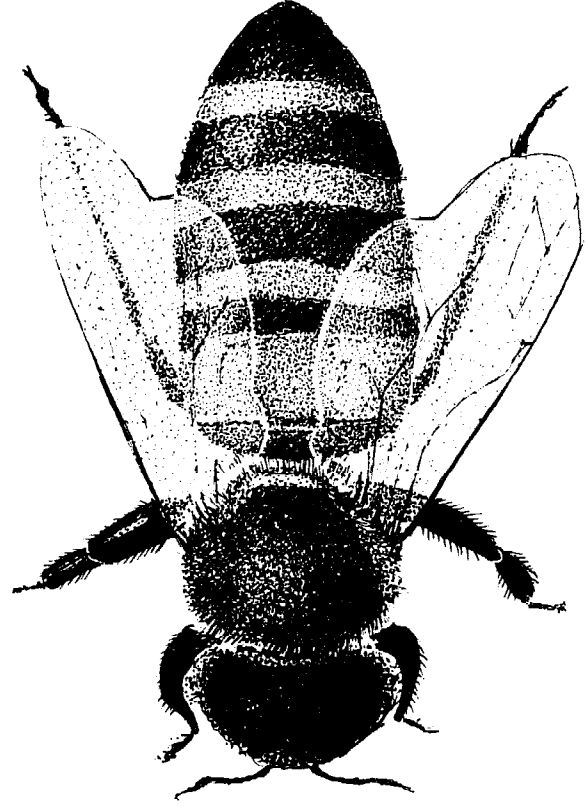

The Worker

THE QUEEN

The queen is the longest bee in the colony; her long abdomen, usually without color bands, distinguishes her from both workers and drones. Any larva which hatches from a *fertilized egg* is a potential queen. Thus worker bees can raise a new queen from larvae when their old queen has been accidentally lost, or when she is injured or too old to perform her duties well. This fact also permits queen breeders to raise queens from very young worker larvae.

The destiny of larvae hatched from fertilized eggs depends upon their diet. Larvae which are fed royal jelly (the high-protein substance secreted by young workers) throughout their larval period will develop into queens.

Worker bees prepare special cells for the rearing of queens. These cup-shaped cells are usually located on the lower edges of the combs. Many queen cups constructed in the spring may indicate that the colony is beginning swarm preparation (see *SPECIAL MANAGEMENT PROBLEMS: Swarming*).

If, on the other hand, a small number of these cups are found elsewhere on the comb or worker cells are modified into queen cells it may indicate that bees are preparing to *supersede* or replace their existing queen. This may be due to her age, an inadequate amount of *queen substances* (queen pheromones), low egg production, injury, disease, or some combination of these deficiencies (see *SPECIAL MANAGEMENT PROBLEMS: Queen Supersedure*).

The cup-shaped cells become *queen cells* after eggs are laid in them by the queen. The larvae in these cells are fed copiously with royal jelly and, as the larvae grow, the cells are elongated and take on the characteristic peanut-like appearance and hang vertically from the comb.

In cases where a queen is suddenly lost due to some accident, no queen cells will exist (unless, by coincidence, the bees are in the process of swarming or superseding their queen). In such cases, the worker bees "select" and feed larvae in worker cells which are less than two days old. The workers add wax to the cells as the larvae grow, and peanut-shaped queen cells gradually form in the midst of the capped worker cells.

After emerging, a virgin queen may begin to search for and partially destroy any other queen cells, leaving the workers to discard the pupae or larvae inside. Some cells may contain queens ready to emerge, in which case she will partially open these cells and sting the occupants. While performing these tasks, she may also encounter other emerged queens; fighting ensues and ultimately only one virgin queen survives.

About six days after emerging, the queen will leave the hive on a mating flight; if weather is inclement, this flight will be delayed until more favorable weather appears. During her flight, the queen's pheromones attract male bees from *drone-congregating areas*, and she may mate with up to ten or more drones in succession. When her sperm

The Queen



sac (spermatheca) is filled, she returns to the hive and will never leave it, unless it is in the accompaniment of a swarm. Three days or so after mating, the now bigger and heavier queen will begin to lay eggs. The queen continues to lay eggs the rest of her life, pausing for a month or so late each fall. It has been reported that a good queen is able to lay up to 2,000 eggs a day for brief periods.

Genetic Traits

Since the queen mates in the open, the beekeeper has limited control over which drones will inseminate her. Those few that do mate with her may be from several apiaries and/or from "wild" colonies.

As a consequence of this random mating pattern, the queen's sperm sac may contain semen from genetically different drones. Her worker bee and queen progeny, therefore, will consist of individuals that are not necessarily genetically alike (that is, they will be half-sisters). The drones, hatching from unfertilized eggs (parthenogenesis), would all be full brothers, since the queen will lay genetically similar drone eggs whether she has been inseminated or not. Only when the queen has been artificially inseminated with semen from known drone stock will a colony's workers be nearly identical.

Since the queen is the sole egg producer, she is responsible for all the genetic traits of a colony; if the characteristics in a colony are undesirable, requeening should change the hive's genetic makeup and therefore its character. Unless hybridized, the queen should be of superior purebred stock to optimize the desirable traits.

The queen is responsible for all of the following characteristics of the colony:

- | | |
|---------------------------|--|
| -color | -longevity |
| -temperament | -cleanliness |
| -industry and production | -total hive population |
| -swarming tendency | -brood pattern |
| -winter hardiness | -tongue length |
| -propolizing tendency | -handling ease |
| -burr-comb building | -whiteness of honey cappings |
| -nectar-carrying capacity | -conservation of stores in inclement weather |
| -disease resistance | |

Notes

THE DRONE

The *drone*, or male bee, is a large, chunky, blunt-ended bee with very large compound eyes that meet at the top of his head. The drone larvae hatch from *unfertilized* eggs. Under normal conditions, unfertilized eggs are laid by a mated queen in the hexagonal wax cells similar to, but larger than, worker cells.

After six and one half days of feeding, the cells of drone larvae are capped with wax. The capped drone cell is dome-shaped, like a bullet's head, and is readily distinguished from the slightly convex shape of the capped worker cell. Beginners often mistake these drone cells for queen cells. Capped cells lying on a *horizontal* plane are either worker or drone cells; those which are ultimately peanut-shaped and suspended on a *vertical* plane are queen cells.

The newly emerged adult drone begs food from a worker bee, but later he feeds himself from the honey stores. Adult drones have no sting (the sting is a modified female egg-laying structure) and have very short tongues (unsuitable for gathering nectar). Drones never collect food, secrete wax, or feed the young. Their sole known function is to mate with virgin or newly mated queens.

Drones first leave the hive (about six days after emerging) on a warm, windless, and sunny afternoon. As they get older, they fly to locations known as *drone-congregating areas*. Whenever the drones in these areas detect the pheromones of a virgin queen or newly mated queen they pursue her, and a few succeed in mating with her; those few die soon after mating.

Whenever there is a dearth of nectar (when no food is being collected), worker bees expel drone brood and adult drones from the hive. During the summer, beekeepers often see workers dragging drones in various stages of metamorphosis out of their cells and dropping them in front of the hive. Normally in the fall all adult drones and any remaining drone brood are gradually evicted from the hive. The evicted drones probably die of starvation or exposure. Queenless hives and those with laying workers or drone-laying or failing queens, usually retain drones longer.

The Drone Layers

A queen that fails to mate can lay only unfertilized eggs. Similarly, a failing queen is one that did mate but now lays all or mainly drone eggs since her semen supply is almost or completely depleted. Some workers of hopelessly queenless hives (unable to make another queen) may undergo ovary development and start to lay eggs. These eggs are, of course, unfertilized. All unfertilized eggs laid by mated, unmated, or failing queens or by *laying workers* will produce mature drones, capable of mating.

The Drone

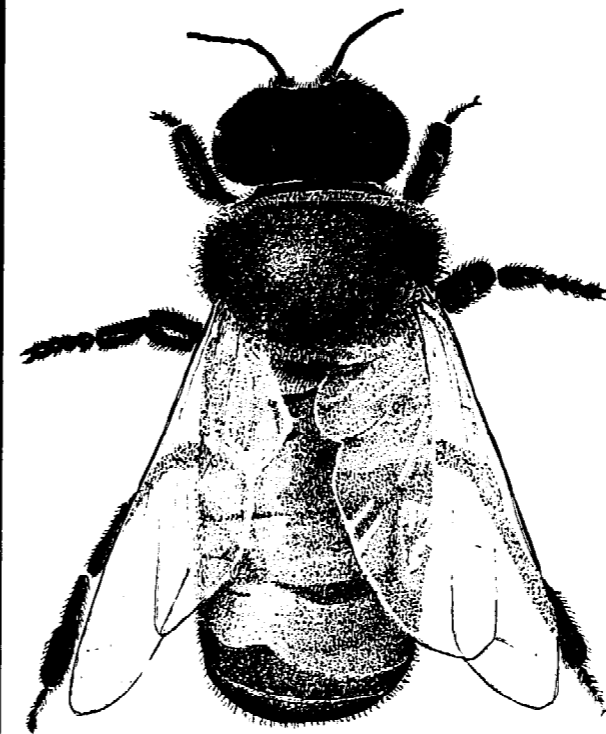

Unlike a mated queen, a failing or unmated queen will often lay drone eggs in worker cells; laying workers usually place their eggs in worker cells as well. Although these drone larvae are in worker cells, their cappings will have the characteristic dome-shape found on regular drone cells. Drone cappings over worker cells, therefore, indicate the presence of an unmated or failing queen or laying workers.

Another indication of a drone-layer is a scattered brood pattern. Upon closer inspection, it may be found that each uncapped cell within a scattered brood pattern contains not one, but several eggs. These eggs, instead of being deposited at the bottom of the cell as is characteristic of eggs laid by queens, adhere to the cell walls. These eggs have been deposited by laying workers.

The presence of occupied drone cells in the spring, summer, and early fall in a *queenright* colony (where a healthy, mated queen is present) is a normal part of the colony cycle. One should not attempt to destroy or reduce the number of drones, either by trapping adults or by cutting out cells of drone brood. Their numbers will not substantially reduce the honey output of the colony. If, however, a colony has numerous drones due to old, sagging combs full of drone cells, these combs should be replaced with frames of *foundation* (see *EQUIPMENT AND BEE SUPPLIES: Foundation*). Since the foundation is of worker-sized cells, the frames will soon be filled with worker larvae, and the drone population will decrease naturally.

Relative Cell Sizes

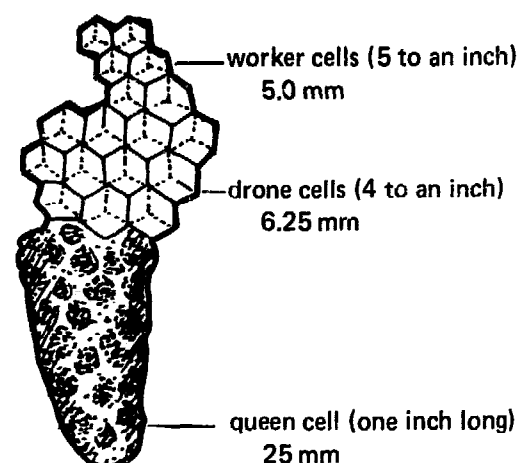

COLONY ACTIVITIES

General

Beekeepers and researchers have not been fully able to sort out and comprehend all the interrelated factors regulating the activities and behavior of a bee colony. As has been already discussed, the worker bees are responsible for doing many of the tasks necessary to maintain the colony unit. The duties performed by the workers can be divided into two categories: the *hive duties* and the *foraging duties*.

When a beekeeper opens a hive, or examines a colony within a glass observation hive, these two separate groups can be seen performing the tasks allotted to them by age. A brief discussion of some of the more important duties is presented in this section (see also *REFERENCES: Books on Bees*).

Comb Building

The wax comb is the nest and abode of the honey bee. In the wild, the comb is usually confined within a dark enclosure such as a hollow tree, although some nests can be found in the open. The wax for the nest is produced by workers who fashion it into the hexagonal "honeycomb" cells in which eggs hatch and brood develops. Hexagonal cells not containing eggs or brood are used for the storage of honey and pollen (see *illus.*). Wax is also used to construct queen cups and the cells used to rear queens. After queens have been reared, bees usually remove these queen cells.

Beeswax is usually produced by worker bees between 12 and 18 days old and is secreted from the *wax glands* located in their abdomens (see *APPENDIX B: Anatomy*). A wax droplet is secreted from beneath the overlapping portions of the last four abdominal segments; on contact with air, the wax hardens to a thin oval *scale*. The bee then transfers this wax scale from the abdomen with its hind legs, passes it to the forelegs, and then to its jaws. The scale is then masticated, softened, and used to begin construction or added to existing comb.

The cells of the honeycomb do not lie on a completely horizontal plane, but are tilted upward slightly. This prevents stored materials and brood from spilling or rolling out of the cells before they are capped with wax. Each comb surface is separated from another by about $\frac{3}{8}$ inch (9.5 mm) which is called a *bee space* (see *illus.*).

Wax glands are stimulated to produce wax when bees gorge honey, nectar, or sugar syrup. When many bees are secreting wax, they hang in festoons or layers. If bees are seen in such a posture, called *festooning*, they are probably producing wax. Wax secretion is stimulated by:

- high temperatures
- plentiful nectar, honey, or sugar syrup
- ample pollen consumption

Because a swarm of bees in engorged with nectar or honey, their wax glands are stimulated, and when placed on foundation they will render or *draw* it into beautiful white new comb.

The Bee Space

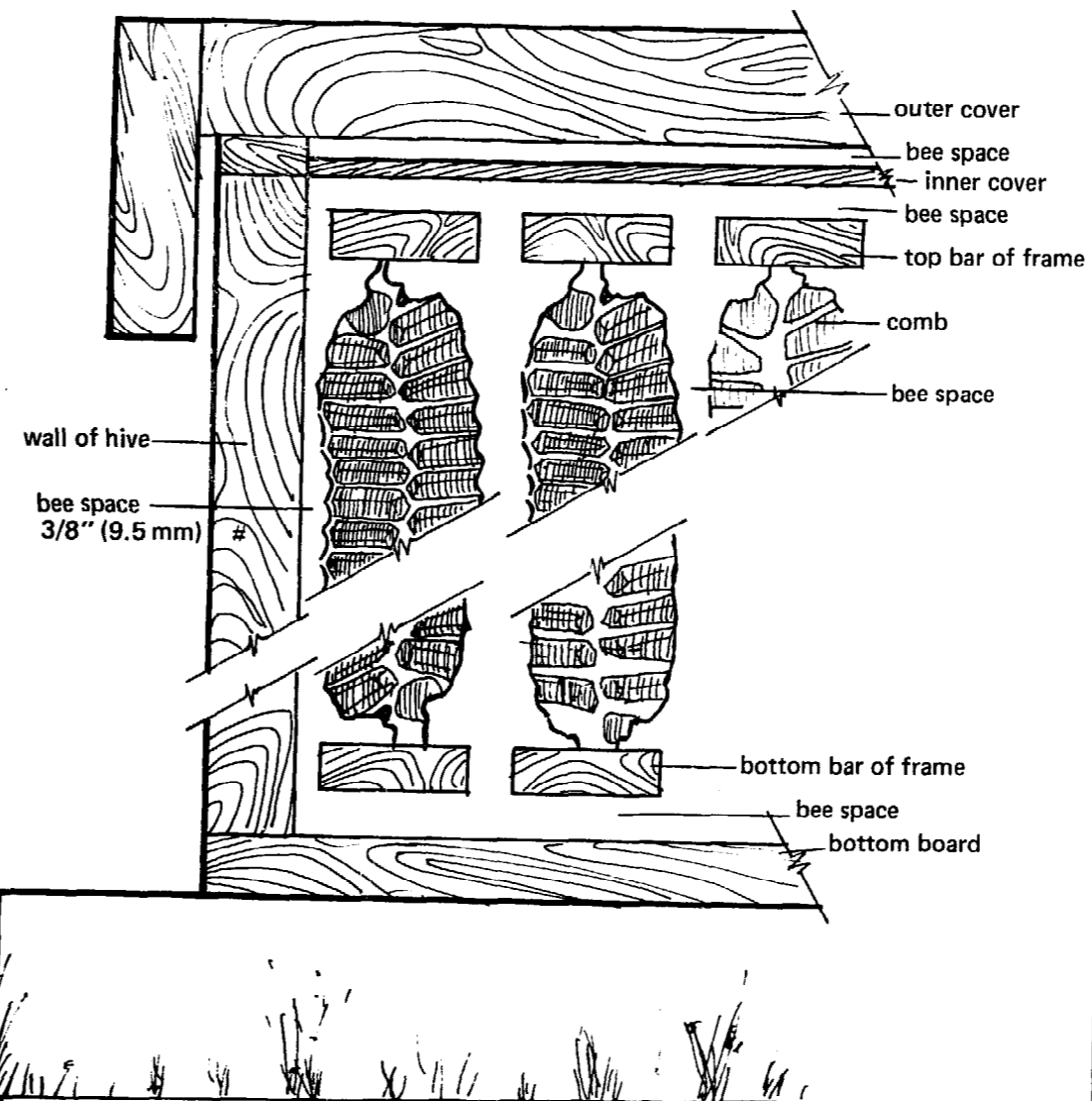

The Bee Space

Bees do not space combs at random in a natural hive, nor in the wooden bee hive. Bees do not construct comb in spaces less than 3/8 inch (9.5 mm).

This fact was published by the Philadelphia minister L. L. Langstroth a little over 100 years ago. It was the basis on which he designed the prototype bee hive used today. The 3/8 inch space enables one to remove frames without having to cut the combs. A 3/8 inch gap separates each of the frames, the hive walls, and the bottom board from parts of each frame, and the top bars from the inner cover of a hive.

By utilizing this natural spacing, the beekeeper ensures that the bees do not attach comb to the walls or to other sections of comb, and that the frames can be easily removed. If the frames are spaced farther than 3/8 inch apart, or if the beekeeper neglects to return a frame to the hive after examining it, the bees will fill the gap with comb or extend the cells of combs adjacent to this gap. Recent studies indicate some races of bees leave a smaller space that is less than 3/8 of an inch between combs.

Food Transmission and Hive Odor

Bees within a hive exchange honey or nectar. Foragers returning from the fields pass food to the hive bees who then pass it to other bees. Along with this food exchange the queen pheromones are passed first from the queen, then to each bee in the colony; the transmission of these chemical signals helps hold the colony together.

Changes in the concentrations of these pheromones result in modifications in the behavior of the colony (see *SPECIAL MANAGEMENT PROBLEMS: Swarming and Queen Supersedure*).

An additional function of food transmission is the spread of the hive's odor. Each hive has its own characteristic odor which may aid the bees in one hive in distinguishing bees from other colonies (such as robbers) and foreign queens (see *SPECIAL MANAGEMENT PROBLEMS: Requeening*). To keep foreign bees out, guard bees patrol the hive and challenge intruders, especially at the entrance. Guard bees are workers that have very high concentrations of the alarm pheromones.

Nest Cleaning

Nest cleaning activities include keeping the nest free from debris and disease, removing healthy brood during a nectar dearth or when the colony can no longer care for the brood, and coating of the interior hive parts with propolis.

To accomplish this, worker bees:

- remove dead or dying brood and adults from the hive
- remove healthy brood, usually drone brood and adults, when the hive is not bringing in much food or in the fall
- remove debris such as grass and leaves
- remove granulated honey or dry sugar
- coat the insides of the hive and wax cells with bee glue or *propolis* (collected from buds or bark of trees;

it is a dark, reddish-to-brown color, sticky when warm, brittle when cold)

- propolize cracks, moveable hive parts including frames, bottom board, and inner cover (some races use more propolis than others; see *UNDERSTANDING BEES: Races of Bees*).

Fanning

Bees can often be seen fanning their wings on the extended landing deck of the bottom board. This fanning also takes place on the portion of the bottom board within the hive that is obscured from view (see illus.).

Some fanning bees position themselves with their heads directed toward the back of the hive so that their fanning draws air out of the hive; other fanners may be facing the opposite direction, forcing air into the hive. By their combined efforts, these separate groups accelerate the movement of air throughout the entire hive.

By circulating air through the hive, bees are able to:

- assist in regulating brood temperature
- evaporate water carried into hive to reduce internal temperatures
- evaporate excess moisture from unripened honey (nectar with a high percentage of water); as this moisture evaporates it too will cool or humidify the hive
- keep wax from melting as temperatures climb

—eliminate accumulations of gases (such as CO₂)

Another type of fanning helps spread workers' pheromones. In this case, the fanning bee's abdomen is raised; a gland (Nassanoff or Scent Gland) located near the tip of the abdomen is opened and a mixture of pheromones is released from it. These chemicals guide other bees toward the fanners.

This type of fanning is commonly seen:

- when a swarm or package of bees is emptied at the entrance or inside a hive
- when bees are shaken off a frame or otherwise disorientated
- when a hive is opened that is queenless or that has a virgin or newly mated queen
- when a swarm begins cluster formation
- as a swarm enters a natural home-site

Washboard Movement

Beekeepers can often observe bees, usually in the early evening, on the front wall of the hive with their heads pointed toward the entrance. These bees are standing on their second and third pair of legs and seem to be scraping the surface of the hive with their mandibles and front legs, as if to clean it. As they scrape, their bodies rock back and forth in a motion similar to one scrubbing clothes on a washboard. This is called the washboard movement. The exact purpose of this activity is not presently understood.

Fanning Bees Circulating Air in a Hive

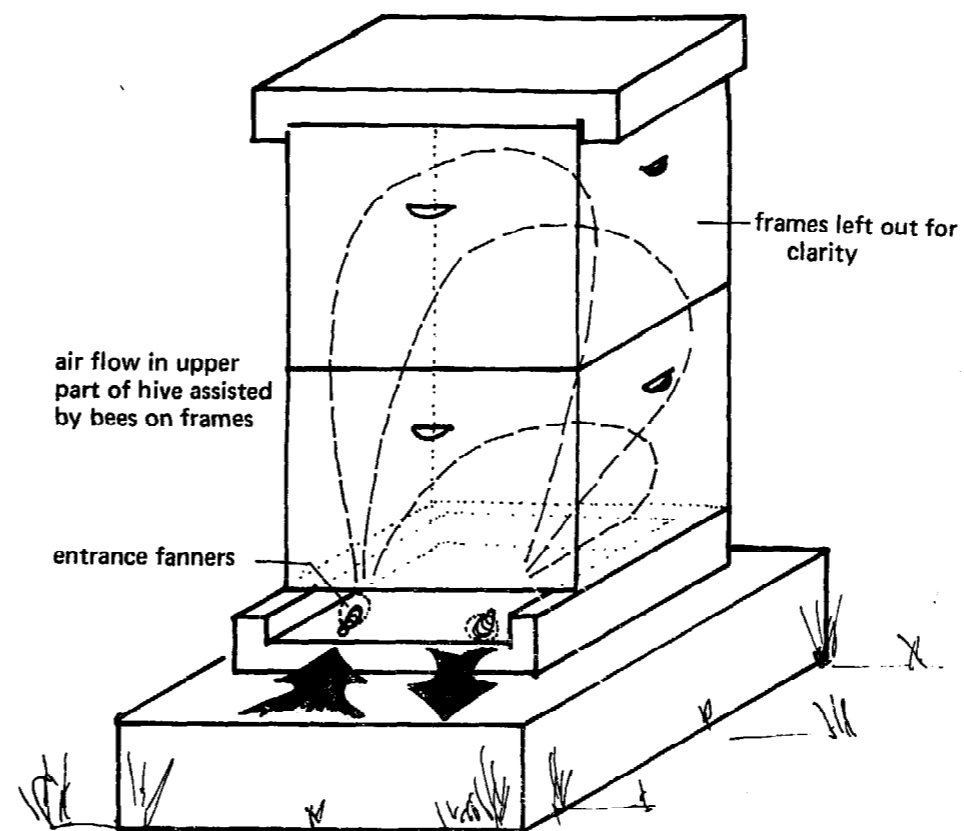

Colony Defense

Worker bees will defend their hive by flying at and often stinging an intruder. Such action should not be interpreted as "meanness" but rather as a defensive action. When an intruder approaches and enters or begins to open a hive, some bees raise their abdomens, begin fanning, and thereby disperse the alarm odor being released by a gland at the base of the sting. This pheromone has an odor similar to that of banana oil. It incites other bees to defend the colony. Once some of the attacking bees sting clothing or skin, some alarm odor remains at the site, tagging the victim. The tagged victim may become the target of further aggressive acts as long as the alarm odor remains on the clothing or skin.

Flight

Except for occasional orientation flights, worker bees generally remain within the hive for the first three weeks of their adult life, cleaning, feeding, building comb, ripening honey, and packing pollen. These routines are more or less discontinued at the end of the third week as bees turn to tasks which require flight.

An ability to recognize the different types of flying activity will permit the beekeeper to interpret activities at or near the hive entrance.

Orientation. Bees on orientation flights familiarize themselves with landmarks surrounding their hive. These bees hover near the hive entrance for very short periods of time.

Foraging. Foraging bees fly out and away from the hive in a definite direction in search of food, propolis, and water. Their return flight usually takes them straight into the hive or onto the bottom board.

Robbing. Unlike orientation flights, which are short in duration, robbing activity is similar to foraging activity. Upon first approaching a hive, the robbers sway to and fro in front of a hive to be robbed in a manner somewhat similar to a figure eight. Once the hive has been invaded, other robbing bees are "recruited" to it.

Cleansing or Defecating Flights. On warm winter days, when the air is calm, bees fly out of the hive to defecate. Often, they circle in the vicinity of the hive releasing body wastes in the air. Package bees also take cleansing flights after being released, since they have been confined for several days. The outside of the hive can be spotted with brown or yellowish spots as a result of winter cleansing flights or package bee flights. If the flight takes place when the ground is covered with snow, these yellow or brown spots appear peppered on the snow.

Foraging and Communication

The gathering of food for feeding larvae and for storage requires a high degree of cooperation and communication among the members of a colony. Haphazard searches for food by the older worker bees would require too much energy and could not be sustained over long periods of time without adversely affecting the well-being of the colony. Communication among

the bees increases the efficiency of food gathering activities by recruiting more bees to available and abundant food sites.

A worker bee orients herself according to various external stimuli as she comes from and goes to collecting locations:

- the sun's position and polarized light
- landmarks, both horizontal and vertical
- ultraviolet light, enabling her to see the sun on cloudy days

A worker bee is able to inform other bees about the location of a food source through a series of body movements, called *dances*, which include wing vibrations, odor, and glandular secretions. (The function of these dances was first reported by Karl von Frisch.) Bees returning from a particularly rich food source will excite other foragers and notify them about where to find it by dancing. There are two basic dances—the Round Dance and the Wag-Tail or Figure Eight Dance. The Round Dance communicates distance (up to 300 feet, or 100m) from the hive in any direction. The Wag-Tail or Figure Eight Dance communicates both distance and direction (see illus.). The flavor, odor, and sugar concentration of the food act as both a stimuli and guide to recruited bees.

Another type of foraging that bees engage in is *robbing*. Bees occasionally obtain honey, nectar, or sugar syrup from other colonies. Robbing often occurs when a beekeeper is examining or feeding a colony; bees from other hives fly over and steal some food from the exposed

frames. If the hive is not quickly covered, the robbers will recruit other bees to return for more bounty. Robbing is especially severe when there is a dearth of nectar.

Round Dance

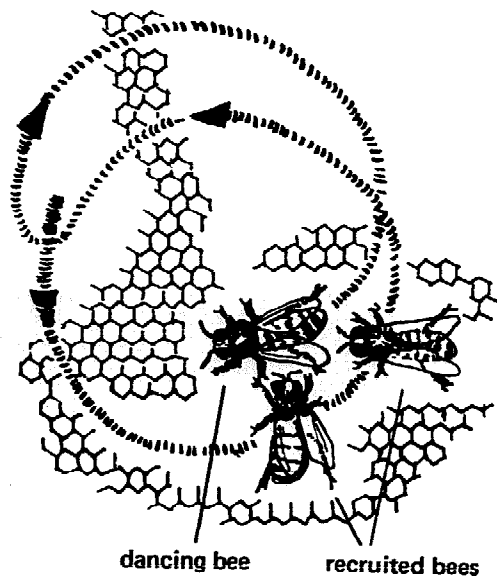

Wag-Tail or Figure Eight Dance

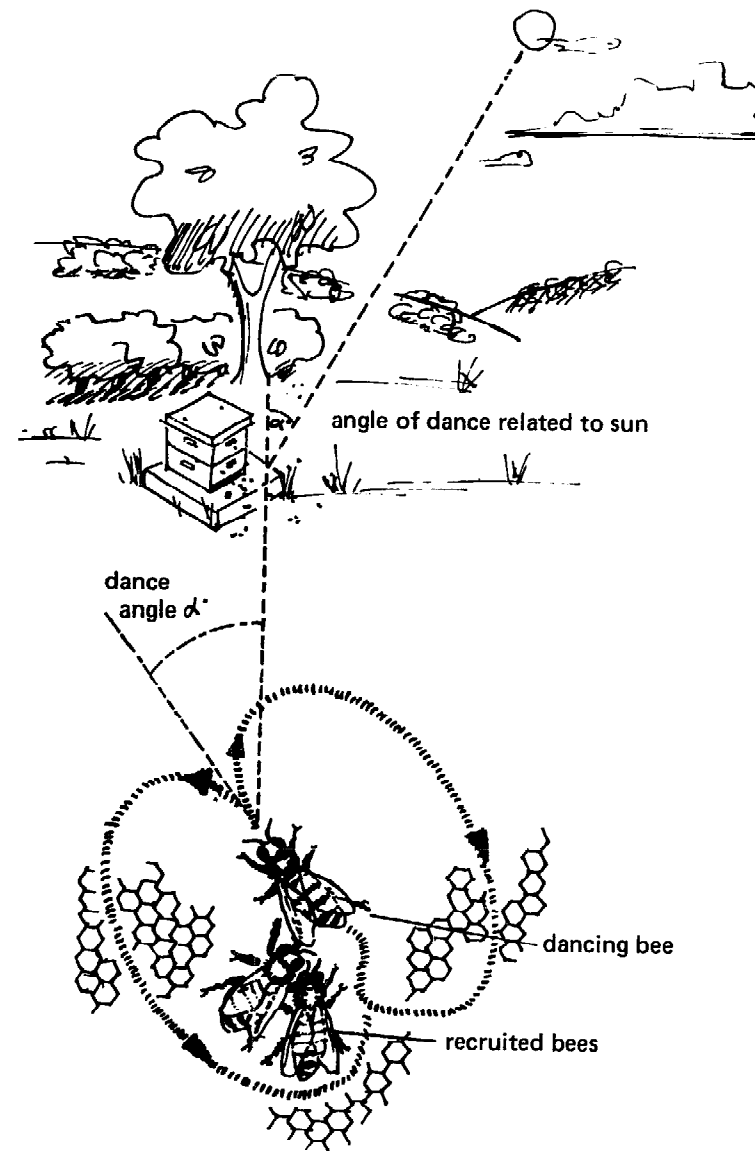

Equipment and Beekeeping Supplies

GENERAL INFORMATION

During the summer, a bee hive which houses a full colony of bees normally consists of a bottom board, two deep hive bodies for the broodnest, a queen excluder, one or more standard or shallow supers (the number depending on the abundance of nectar, or the *honeyflow*), and an inner and outer cover.

Some beekeepers use only standard supers for their hives; others use the shallower supers for both the brood and the honey. If only the deep hive bodies are used, lifting off the honey will be very strenuous. If, on the other hand, only shallow supers are used, finding the queen becomes much more time consuming and disruptive to the colony.

The number of hive bodies left for bees in the winter can vary. Some beekeepers winter their bees in two deeps and a shallow, using the shallow for winter stores of honey and pollen. In certain parts of the country colonies are wintered in one deep and one shallow, or two deeps, or sometimes even in three deeps (see *SPECIAL MANAGEMENT PROBLEMS: Wintering*). In all cases, an ample supply of food must be provided.

It has been traditional to paint the hive bodies white to reflect the sun's heat in the summer months and help keep the colony cool. Even the metal top of the outer cover might be painted white to reflect more heat during the hottest summer months. While white is most favorable in southern climates, beekeepers in northern areas might consider painting hives darker shades to retain the heat longer. For hives located on wooded sites, where it is shady most of the time, darker colors might prove especially beneficial.

Whatever color is used, the outer sides and rims of the wooden hive parts should be painted in order to extend the life of the equipment and to retard rotting. Since bees produce moisture as a part of their metabolic activity, a latex paint would be least likely to blister as the moisture leaks out; lead-based or other toxic paints should never be used.

Some equipment, like frames and hive bodies, is now available in plastic. Any experimentation with plastic equipment should be done slowly; the beekeeper who buys all plastic equipment may risk losing all the bees if they should suddenly decide—as bees sometimes do—that they don't like plastic (see *REFERENCES: Equipment*).

In areas where loss of beehives through theft is a concern, all wooden hive parts should be branded and registered with individual identification.

Basic Hive Parts

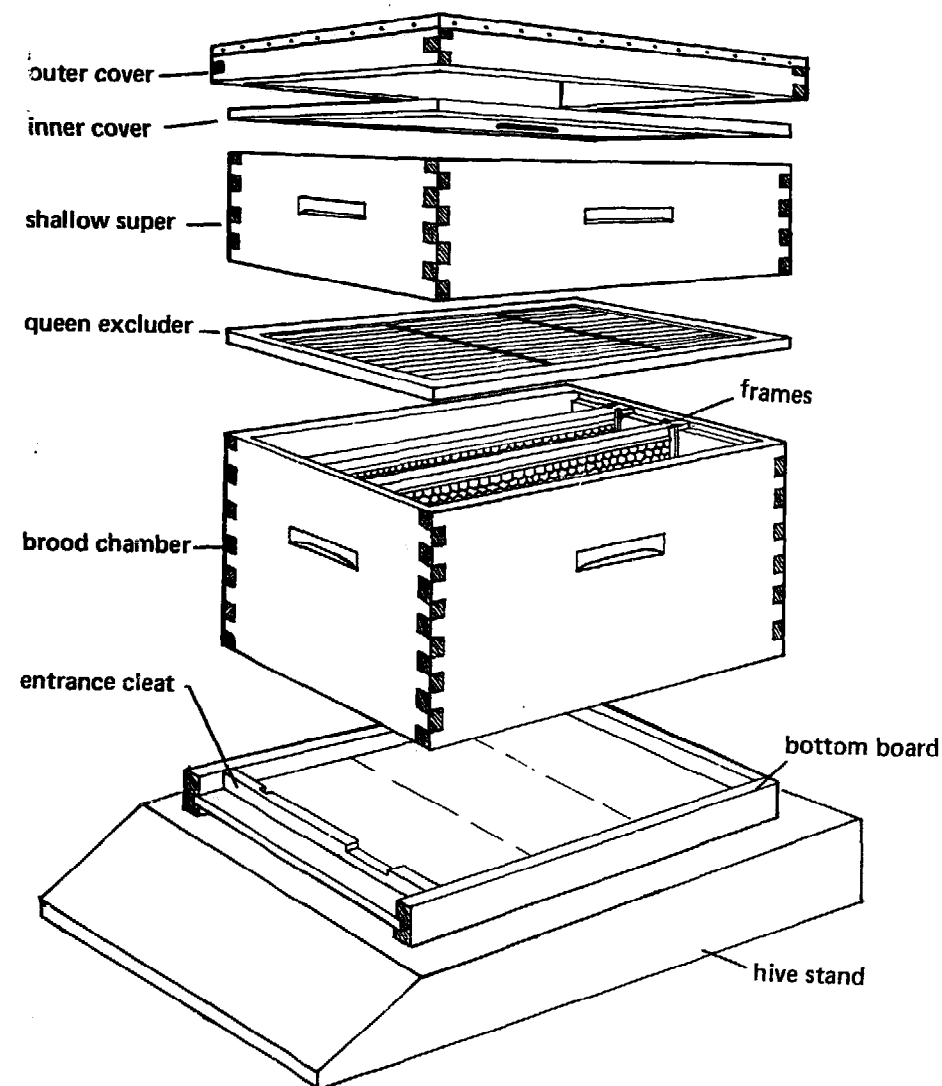

BASIC HIVE PARTS

Outer Cover

Sometimes called the telescoping cover, it is usually made of wood and covered with tin or aluminum. This cover overlaps or telescopes over the rim of the inner cover and hive body. A flat wooden cover is used primarily in the drier areas of the western U.S.

Inner Cover

The inner cover, sometimes called an escape board, is a wooden, masonite, or plastic board that has about a 1/2 inch rim (13 mm) on one side and an oblong hole in its center into which a *bee escape* fits. When honey is to be removed, a bee escape is put in place and the inner cover is placed below a honey super; the workers then move down into the brood chamber but not back up into the honey super.

Whenever it becomes necessary to feed a colony, food can be placed on top of the inner cover, enclosed within an empty super and the outer cover, allowing the bees to pass through the oblong hole to collect the food (see *FEEDING BEES*). The hole in the inner cover can also serve to rid the hive of excess moisture, particularly in the winter when the inner cover can be placed between the honey supers and an extra super full of absorbent insulating material such as straw (see *GENERAL SEASONAL MANAGEMENT: Wintering Techniques*).

Shallow or Honey Super

The shallow super comes in various depths, from 4 13/16 inches (12.2 cm) to 7 5/8 inches (19.4 cm) with frames of corresponding depth. The most common shallow super is 6 5/8 inches (16.8 cm). There may be several supers per hive since most of the honey is stored in them. Although the standard supers are designed to hold ten frames, some beekeepers put only eight or nine frames in the honey supers so that the bees will draw out the comb more. (The different super sizes are illustrated in *GENERAL SEASONAL MANAGEMENT: During the Honeyflow; super sizes*).

Queen Excluder

A zinc or plastic perforated sheet, or a wooden-framed grill, the excluder allows only the worker bees to pass through; the larger drones and queens cannot. This is placed on top of the broodnest to prevent the queen from entering the honey supers above. It is also used in two-queen colonies or for any manipulation in which the queen is to be excluded (see *SPECIAL MANAGEMENT PROBLEMS*).

Hive Body

The standard-size hive body is 9 5/8 inches (24.5 cm) in depth. Ten full-depth frames should be used when they are started with wax foundation so that they

will be evenly spaced within the hive body and so that the comb will be evenly drawn out by the bees. Some beekeepers later remove one frame to allow easier manipulations of the hive and use special spacers (like Stoller Spacers) or *follower boards*, or they merely space the nine frames evenly by hand (see *APPENDIX D* for hive plans).

Bottom Board

Hive bodies are placed on a bottom board, which should never be placed directly on the ground as it would quickly rot. A wood preservative like creosote will help protect the underside of the bottom board, but the preservative should be allowed to dry thoroughly before placing the board under a colony. It is unnecessary to paint or coat the interior hive parts with any substance.

One type of bottom board has two rim heights—a short winter rim and a deeper summer rim—and is called a *reversible* bottom board. Many beekeepers, instead of reversing the bottom board, use an *entrance cleat* to reduce the hive opening in the winter. Plastic bottom boards are available as well, but they sometimes buckle if the hive is very heavy.

Hive Stand

To keep the bottom board off the ground, some type of stand should be

used (see *BEFORE THE BEES ARRIVE: Hive Stands*).

FOUNDATION

Foundation is a thin sheet of beeswax impressed with the hexagonal shape of a worker-sized cell. This sheet is set in the center of a frame and wired or pinned in place. When put into a hive of bees that are gorged with honey, nectar, or syrup (a state which induces worker bees to produce wax), the bees will use the foundation as a base and draw up the walls of the cells. Once completely filled out, the frame is said to contain *drawn comb*.

There are many kinds and thicknesses of foundation, but basically the thicker sheets with inlaid vertical wires are used for brood frames and extracting supers. The thinner foundation is used in the honey supers and for section comb honey. Drone-sized cell foundation is also available for comb honey supers or for other uses.

To set the foundation firmly in the frame, especially in the brood frames, horizontal wires should be strung across the wooden frame (see illus.). The imbedded wires help keep the comb from sagging and the cells from stretching due to the warm temperatures within the hive during the summer months. The distorted cells in sagging comb are unsuitable for raising worker brood and may even allow increased numbers of drone brood.

Foundation is also available reinforced with plastic rather than wires; a plastic sheet is covered on each side with bees-

wax and imprinted with the hexagonal pattern. Such foundation is easy to install but if the wax separates from the plastic base, the bees may not work it.

Foundation should be stored away from heat and freezing temperatures; if kept in plastic bags the wax sheets will remain fresh and soft.

Setting Foundation

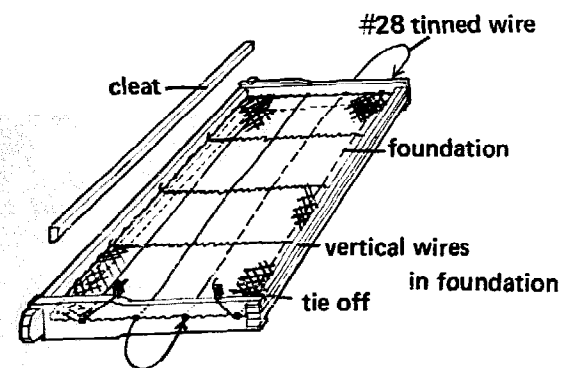

BEGINNER'S LIST

Most hive parts come disassembled and some parts require painting. Some bee supply companies sell plastic equipment, but most hive parts are made of western pine. For two complete hives one would need:

-2 standard hives, consisting of 2 deep hive bodies, inner and outer covers, bottom boards, 20 wooden frames	\$ 60.00
-2 additional deep bodies with frames	17.00
-6 lbs. (40 sheets) medium brood foundation, wired	25.00
-1 large 4 X 10 inch smoker	11.00
-1 square-folding veil, plus helmet	15.00
-1 lb. #28 tinned embedding wire	3.50
-1 spur embedder, to embed wire in foundation	1.50
-1 10-inch hive tool	2.50
-1 gallon white exterior latex paint	12.00
-4 shallow supers with frames (6 5/8-inch hive body, 6 1/4-inch frame)	40.00
-40 sheets foundation for shallow supers	19.50
-medication (Fumildil-B and Terramycin)	12.00
TOTAL	\$219.00

Optional Equipment:

-bee gloves	\$ 8.00
-bee suit	18.00
-queen excluder	5.00
-bee escape	.50
-extra hive tool	2.50
-bee brush	1.50
-division-board feeders (10)	20.00
-pollen substitute (for 10 colonies)	3.00
-uncapping knife	21.00
-honey extractor (2-frame hand powered)	116.00
-jars, bottles, labels	4.00
-branding iron	60.00

The prices listed are approximate 1977 prices which will vary some depending on make, supplier, etc.

FOR THE BEGINNER

To the beginning beekeeper, the plethora of equipment available from the bee catalogues may prove somewhat confusing; the basic equipment listed under the *Beginner's List* provides a starting point.

It is generally not a good idea to keep just one hive, since the queen could become injured or die, perhaps leaving the colony with laying workers. Two to five colonies would be a manageable number of hives for the beginner.

While used hive bodies and frames are less expensive than new equipment, they could be contaminated with brood diseases which are not readily apparent. If equipment is questionable, it should be sterilized. The most economical way to sterilize such equipment is to place it in an ethylene oxide chamber. Some state agricultural departments now have these chambers, and the cost for sterilizing old equipment is minimal.

Other more expensive equipment, such as honey extractors, can be shared by several beekeepers on a cooperative basis. Hobbyists are cautioned not to buy every gadget on the market. When in doubt about the usefulness of a particular piece of equipment, seek the advice of other beekeepers.

Bee Veil

A bee veil is a must. Although photos appear in bee magazines and elsewhere which show beekeepers working without veils, such practice is discouraged. Stings

on lips, scalp, or inside the nose or ear canal are extremely painful; it is downright foolish to risk them. All sensible beekeepers wear veils. Veils can be purchased separately or attached to helmets.

Bee Suit

Homemade bee suits, or those purchased from a supply house, are of white cotton and have pockets and pouches to carry hive tools, matches, and the like. For the do-it-yourselfer, a jumpsuit pattern made two sizes larger than one ordinarily wears and with an extra long collar and sleeves works very well. The suit will not only protect against stings, but will keep one's clothing free of propolis, which is very hard to remove. The collar should be turned up before putting on a bee veil.

Trouser and sleeve cuffs should be designed to close tightly. Gauntlets made for wrists and ankles will keep bees from getting beneath clothing. Some beekeepers tuck their trousers into shoes or socks or fit cuffs with elastic; leg straps for trousers are also available. If clothing is not closed tightly, bees will crawl underneath unnoticed, and when a bee is pressed between clothing and skin it will sting. Once a bee gets inside the clothing, one may attempt to release it or crush it before it stings.

Bees are less likely to sting people wearing light-colored attire. Bees are more prone to sting dark, furry objects, so avoid dark clothing when working with bees.

Bee suits should be washed occasionally to keep down accumulated dirt. Lighter weight material is best, since the best part of the day for working with bees is usually also the hottest part of the day. Unbleached muslin is an excellent material for a bee suit because it is inexpensive and easy to wash.

Bee Gloves

Many old-time beekeepers disdain using bee gloves, but for the beginner it is a good idea to start with them. Gloves that do not fit well will make handling frames more awkward and may even invite more stings than no gloves at all. All bee supply houses carry men's sizes, and the smaller women's sizes can be ordered from British supply houses (see *REFERENCES: Beekeeping Supplies: foreign*). Gloves are a great help in keeping wax, honey, and propolis off your hands, but should be washed periodically (especially after working with diseased bees). One disadvantage of gloves is that they may retain the alarm odor long after bees sting them.

After gaining a bit of experience and increased confidence in working with bees, even the relatively new beekeeper may sometimes choose to work without gloves. Gauntlets that fit over the arms, keeping the hands free, are an added protection, but leather watch bands should be pocketed during barehanded apiary work since they seem to incite bees to sting.

Hive Tool

Two types of hive tools are available. One type can usually be found in most large hardware stores (see illus.). Either tool is an invaluable aid to the beekeeper when prying apart hive bodies and frames that have been propolized.

It is a good idea to have several hive tools on hand since they are easy to misplace. The hive tool should be periodically sanded clean of excess propolis and wax. Brightly colored paint will help keep them from being lost in the grass. The ends should be sharpened at least once a year.

Maxant Hive Tool

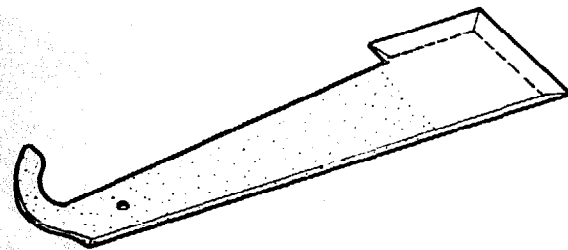

Regular Hive Tool

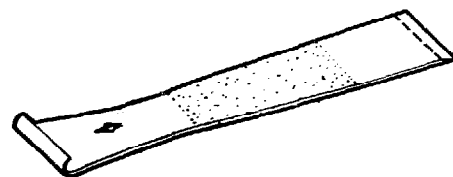

Bee Smoker

The smoker is a metal cylinder with attached bellows in which a fire is lit. Smoke blown from the smoker's nozzle (see illus.) is directed into the hive and between the frames to encourage bees to gorge honey. Once engorged, bees are more docile and less prone to sting. When purchasing a smoker, get the largest available size (see *HANDLING BEES; smoker*).

Smoker

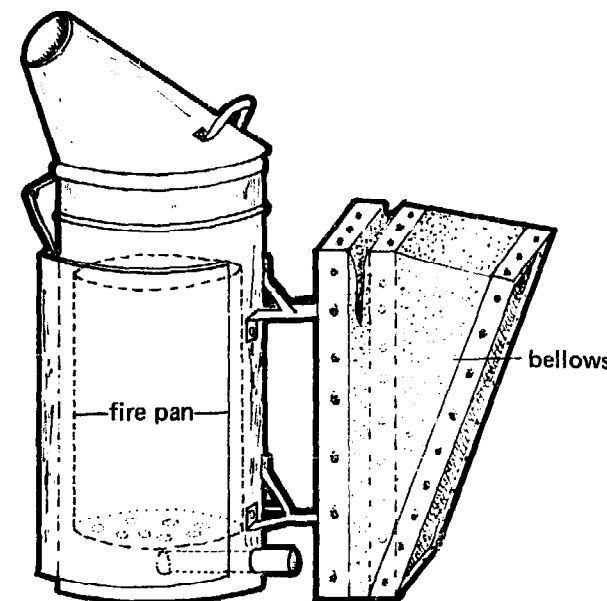

Bee Escapes

Bee escapes are primarily used to remove bees from hive bodies containing honey so that the honey can be harvested free of bees (see illus.). These devices can also be used when one has to move a hive that consists of more than two hive bodies, by first placing the escape board above the second body. After the bees exit, the extra bodies are removed and the remaining hive can easily be lifted and moved.

See *GENERAL SEASONAL MANAGEMENT: Harvesting the Honey; removing bees from honey supers, and SPECIAL MANAGEMENT PROBLEMS: Moving Established Hives*.

The Porter Bee Escape

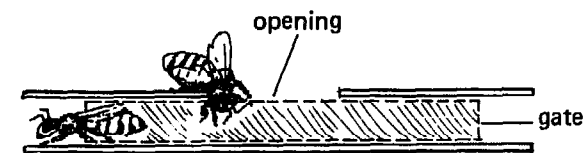

SIDE VIEW

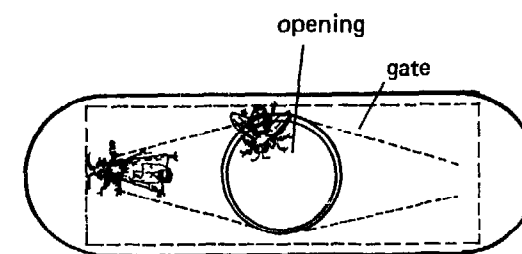

TOP VIEW

Before the Bees Arrive

THE APIARY

The ideal apiary or bee yard should be located to optimize the following conditions:

- close to fresh water; this can be supplied with a dripping faucet or other device
- easy year-round vehicle access
- near food sources, especially waste areas and marsh land
- on top of slopes to improve air drainage away from hives
- away from wet bottomland and stagnant air; honey will not cure properly if too wet
- in open fields with north windbreak and noontime summer shade
- far from fire and flood areas
- near the owner or friendly neighbors to discourage vandals and thieves and to encourage visits
- with entrances oriented to the east southeast to catch sun's early warmth and to keep out prevailing winter winds
- with entrances clear of weeds and other obstructions

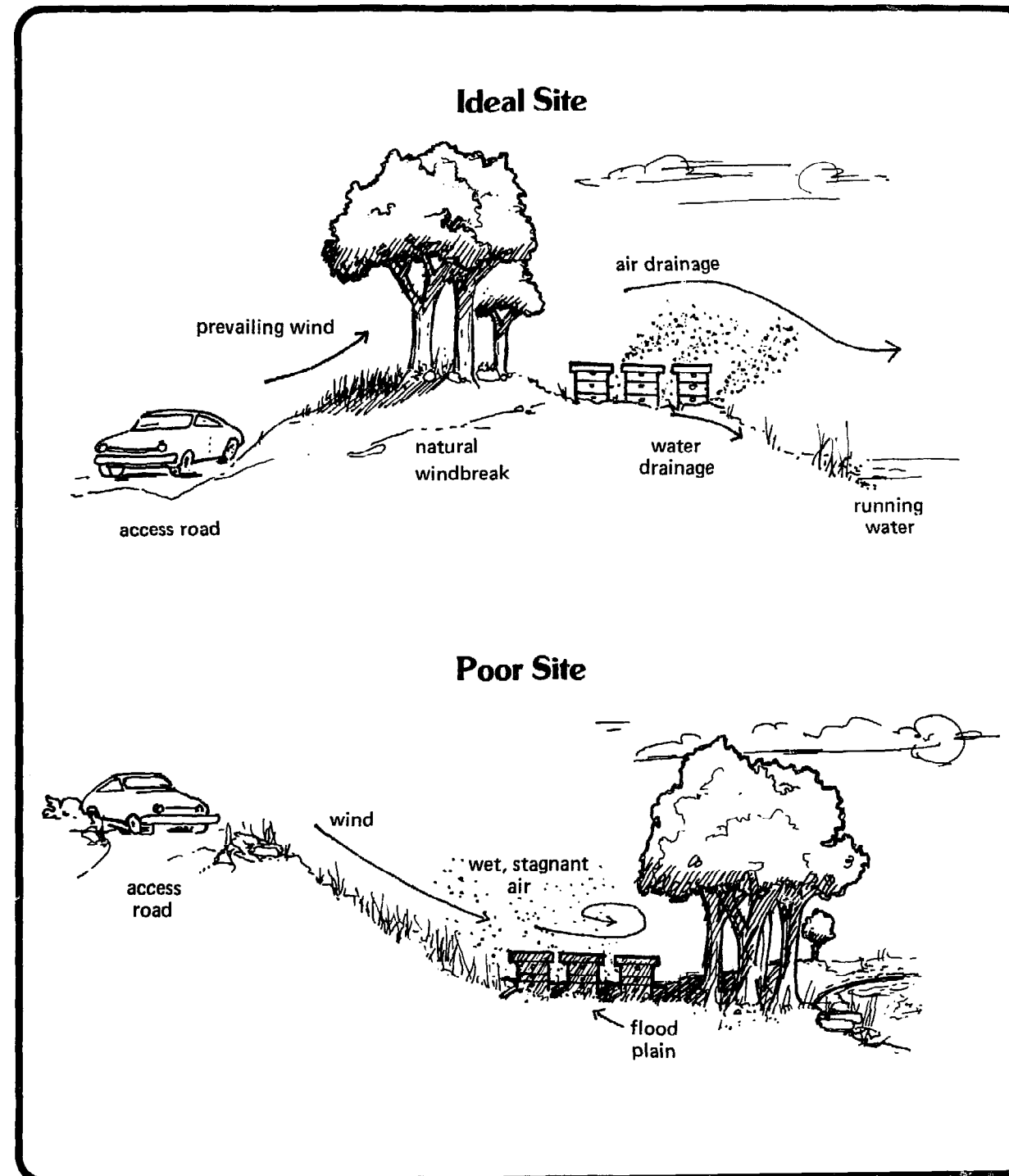

Identification

The name and address of the beekeeper should be posted at each *outyard* (an apiary that is not near the beekeeper's home). This will allow bee inspectors to contact the beekeeper if necessary. If the outyard is located on another person's property, the beekeeper should request a signed statement from the owner that the hives are the property of the beekeeper. This may avoid legal battles in the event of the property owner's death.

Hive Scale

A hive scale is a device which is placed under a strong colony and from which accurate records of weight gains and losses can be made. These scales can be a valuable aid to the beekeeper. If, for example, the scale shows that the hive has grown heavier daily, it means a strong honeyflow is on and the hives can be *supered*—that is, have extra supers placed on top of the brood nest. The scale formerly used to weigh hives was a farmer's grain scale, but several scales specially designed for bee colonies are now on the market.

When a honeyflow is on and the hive is gaining weight because of the nectar being brought in, the beekeeper should be alerted to do certain tasks, depending on the season:

- add frames and/or supers full of foundation, since the worker bee's wax glands are stimulated during honeyflows
- add extra supers for honey storage

(supering)

- begin spring management operations
- interchange the locations of weak and strong hives (see *SPECIAL MANAGEMENT PROBLEMS: Swarm Prevention Techniques*)
- check hives for swarming preparations, especially during or shortly after a spring honeyflow (see *SPECIAL MANAGEMENT PROBLEMS: Swarming*)
- requeen

Whenever the scale shows a hive gaining weight, the beekeeper should check and note which flowers are in bloom in order to anticipate nectar flows in future years. Occasionally, hives may gain weight when no major nectar plants are in bloom. In this instance, bees are gathering *honeydew*, a sugary liquid secreted directly by plants or excreted by insects feeding on plant sap. If, on the other hand, a scale records a continual weight loss, the beekeeper should check the colonies to see why. The colonies may need to be fed in order to prevent starvation; or they may be diseased, queenless or weak, with stores being depleted by robber bees.

HIVE STANDS

The amount of bending and lifting that a beekeeper must do while working a hive can be minimized when the hive is placed on a stand about 18 inches (46 cm) above the ground (see illus.). Such a stand, in addition to saving the beekeeper's back, will keep the hive dry and the

entrance clear of weeds and will discourage animal pests. When working such a hive, the beekeeper can set the hive bodies that are temporarily removed from the hive on an empty super or extra hive stand.

High Hive Stand

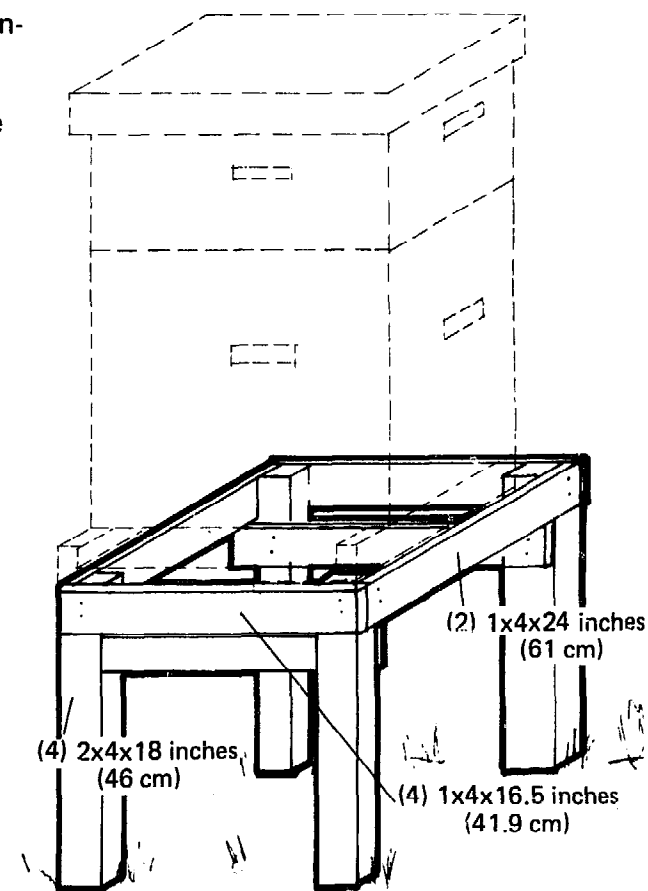

Hive stands also help extend the life of the *bottom board* (see *EQUIPMENT AND BEE SUPPLIES: Basic Hive Parts* for an illustration of hive parts). Wood that is continuously wet or damp will quickly rot. Pests such as carpenter ants and termites are likely to nest in the bottom board when it is in contact with the damp ground (see *BEE PESTS AND DISEASES: Minor Insect Enemies*). Other pests such as skunks and mice have less easy access to hives that are placed on some sort of hive stands.

Some stands are constructed to create a dead air space underneath the hive. This provides extra insulation and can enhance the bees' wintering success (see *illus.*).

Low Hive Stand Forming Dead Air Space

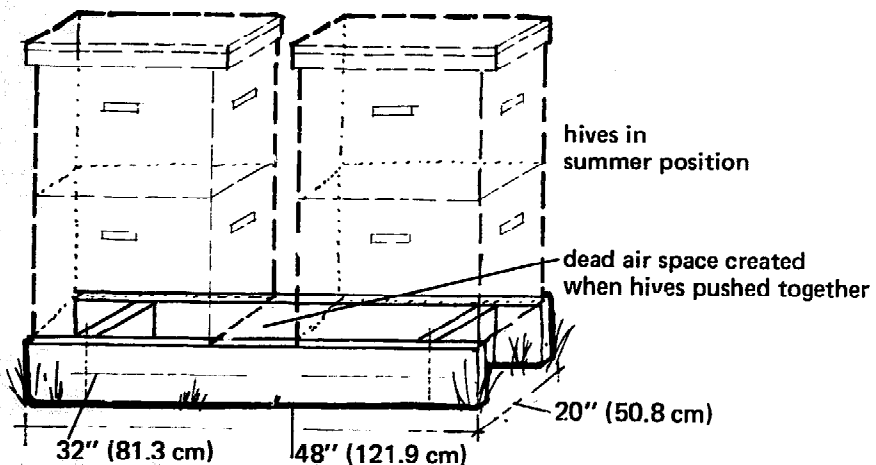

TYPES OF HIVE STANDS

Hives can be kept off the ground by placing them on any one or a combination of these materials:

- cinder blocks covered with tar paper or shingles
- bricks or drain tiles
- wooden railroad ties, pallets, or 2 x 4 inch lumber
- wooden hive stands of durable lumber

Creosote or pentachlorophenol, applied according to directions, will help preserve wooden stands.

HIVE ORIENTATION

In most apiaries, the hives are placed in rows or paired in rows. The hives within a pair should be 6 to 8 inches apart (15 to 20 cm), and there should be 5 to 8 feet (1.5 to 2.4 m) between pairs (see *illus.*).

When the hives are in long rows, there is a tendency for some bees to *drift* to the wrong hives. This drifting may be due to prevailing winds which continually push returning bees toward the end of the rows. Drifting can be reduced by placing the hives in a horseshoe configuration, by putting up a windbreak, or by shortening or staggering the rows. (There might be other reasons for drifting that cannot be completely avoided, however.)

Hive Orientation

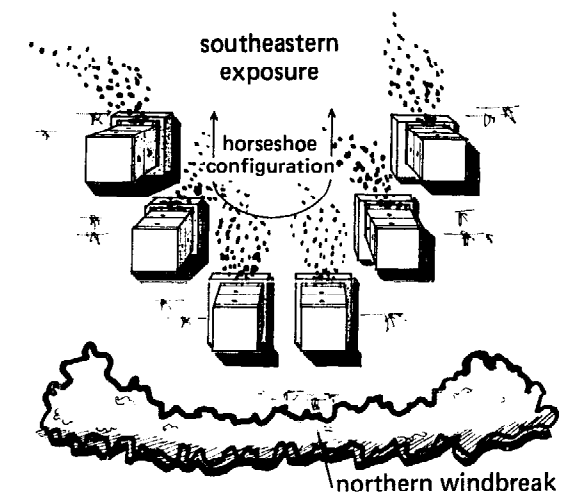

RECORD KEEPING

Careful record keeping will enable the beekeeper to maintain an accurate account of the condition of each hive, as well as to determine beekeeping expenses. Such records are absolutely necessary for those who desire to continually upgrade their stock. The goal that the beekeeper should strive for is gentle bees that overwinter well, remain disease-free, and produce a surplus of honey whenever weather and floral conditions permit (see *HANDLING BEES: The Hive Diary*).

A diary of the blooming times of important nectar and pollen-producing plants will help one anticipate the time when major honeyflows and important sources of pollen will become available. Such information will permit the beekeeper to plan wisely the activities necessary for successful beekeeping.

Financial records should also be kept for income tax and loan purposes and to determine the amount of income lost or gained in a season. Keep records of such things as:

- | | |
|---|--|
| -dates of all beekeeping purchases | subscriptions |
| -equipment bought, destroyed, stolen, or sold | -lectures, talks, shows, and fairs attended or entered, with associated fees |
| -mileage to apiary | -books and conference fees |
| -dead or stolen colonies, queens, or packages | -equipment for selling honey (labels, bottles, etc.) |
| -pesticide loss (Indemnity Program reimbursement) | -amount of honey extracted, bottled, and sold |
| -medications for beekeeper and for bees | -amount of comb honey packaged and sold |
| -organizational memberships; journal | |

(see *REFERENCES: Management of Bee Colonies*).

RESOURCES

There are numerous books, pamphlets, journals, and organizations for beekeepers. In addition, talking and working with other beekeepers can be an important way to learn more about the art and science of apiculture. For the beginner, and for those who wish to learn more about beekeeping, local or state groups and university extension offices usually offer workshops or seasonal meetings for beekeepers to help them improve their techniques or to share experiences.

Listings of some of the resources available can be found in the *REFERENCES* section.

Notes

Obtaining Bees

GENERAL

The beginning beekeeper, or the established beekeeper who wants to enlarge the apiary or set up a new apiary, can obtain colonies of bees by:

- buying package bees
- buying nucleus or established hives
- collecting wild colonies from buildings or bee trees
- collecting swarms

PACKAGES

Package bees come from the southern states and are shipped all over the country in the spring by mail or are picked up by dealers and trucked to their destination. Packages should be reserved in the winter months (December and January) in order to secure the desired number of packages and choice of shipping dates. Request delivery three to four weeks *prior* to the dandelion/fruit bloom in your location.

Generally a three-pound package of bees (about 1.35 kg) will provide the ample amount of bees needed to begin a good colony. The approximate cost (1977) of such a package with one laying queen is \$25.00.

Advantages:

- easier for beginners to work (fewer bees than in an established hive)
- more adult bees than in a nucleus (or small hive)
- certified healthy and from healthy stock
- no brood diseases
- replacements are easy to obtain
- available in 2, 3, 4, and 5 pound units (there are approximately 3,500 bees per pound)

Disadvantages:

- queen could become injured due to stress in shipment
- drifting common (bees fly into other hives or become lost), especially at installation
- dependent on weather; if it is too cold, bees may not "catch"
- no eggs or brood until queen starts to lay; about 21 days until new adult workers emerge
- must be fed heavily to draw foundation since feeding stimulates wax glands to produce wax
- must be fed heavily at least until the first major honeyflow to keep from starvation
- bees may not feed if weather is too cold or wet
- should be medicated

NUCLEUS AND ESTABLISHED HIVES

Nucleus hives (or nucs) consisting of four or five standard-sized frames and established hives, both with laying queens, can be purchased from local dealers or

beekeepers. Before moving any bees and used equipment, check and comply with all legal requirements (see *SPECIAL MANAGEMENT PROBLEMS: Moving Established Hives*).

Advantages:

- cared for by an experienced owner
- owner available for questions
- already assembled
- include all ages of bees and brood, except during one or two winter months
- with established hives surplus honey at the close of the season is almost guaranteed

Disadvantages:

- old equipment may be of different types and sizes
- combs could be old and may have an excess of drone cells that require replacement
- queen could be old or of poor quality and stock
- equipment or honey could be diseased
- large established colonies would be very populous and thus be difficult for beginner to work

OTHER METHODS

A *colony* of bees—consisting of several thousand workers, usually one queen, and sometimes drones—which is living in a building or in a tree can often be obtained free of charge from the owner of the premises, with appropriate permission. A *swarm* of bees is a small portion of a colony between homesites. While swarms are free and generally easy to collect, as a precaution they should be treated as if diseased and be given medicated sugar syrup after installation in a hive (see *SPECIAL MANAGEMENT PROBLEMS: Catching Swarms*).

Bee colonies in buildings are difficult to remove and can cost much in time and stings. The only way to successfully remove the entire colony and its combs involves tearing off the outer and/or the inner portion of the building covering the colony. Removing bees and combs from bee trees usually involves felling the tree and splitting it. Much of the comb and many of the bees, perhaps even the queen, are often crushed when the tree hits the ground. Bees removed from buildings or trees should also be given medicated syrup.

Other methods of obtaining colonies from buildings or trees usually involve leaving an empty hive or a hive with a frame or two of bees and brood near the reduced entrance of the colony to be trapped; this process may take months and often only a portion of the colony may be captured.

Several beekeeping books and/or an experienced beekeeper should be consulted before deciding on any one method of removing bees (see *REFERENCES: Beekeeping Pamphlets*).

Advantages:

- interesting and educational
- free bees to augment weak hives, make nucs, or start new hives
- extra wax and honey from removed combs

Disadvantages:

- bees could be diseased
- queen might be injured or killed
- could require a great deal of labor with little reward
- bees could be inferior stock
- queen is often difficult to find and capture

Notes

Working with Bees

GENERAL

The beekeeper should know what to look for and do before opening a hive. Thus, the amount of time spent at each hive can be kept to a minimum (no more than 15 minutes). Each time a colony is examined the foraging activities of the worker bees are disrupted, and it may be hours before normal foraging resumes. During a major honeyflow, this disruption could result in a measurable drop in the quantity of honey collected.

It has been estimated that an average of 150 bees are killed every time a hive is worked. Bees that are killed or injured release their alarm pheromone, which may excite other bees to become more aggressive. Careful handling of the bees and the hive equipment can minimize the bees' release of the alarm chemical and could reduce the number of stings the beekeeper receives.

Avoid quick movements when working with the bees and do not jar the frames or other equipment. By proceeding slowly and gently, one allows time for the bees to move out of the way. Although killing some bees is unavoidable, the beekeeper who works slowly but precisely can keep the number of squashed bees to a minimum.

WHEN TO EXAMINE A HIVE

A precise timetable for checking hives cannot be given since conditions vary from colony to colony throughout the year, and some hives will require more attention than others. Some general guidelines explaining when to open your hives, and when not to, can be given. A hive should be examined:

- in the spring, when temperatures first reach over 55°F (12.8°C); briefly check the general conditions and determine whether the colony has an adequate food supply
 - after the first fruit bloom, check hives periodically for growth, strength, swarming signs, and such
 - after a major honeyflow, to remove or add supers
 - periodically after a honeyflow, for condition of queen and brood
 - before the winter season sets in
- After making some hive manipulations, check the colony to see how it was affected. For example, check a hive:
- 14 days after installing a package or swarm
 - one week after queen introduction
 - one week after dividing a hive
 - whenever pesticide damage, disease, queenlessness, or similar conditions are suspected

A hive should *not* be examined:

- during a major honeyflow; a hive should not be disturbed unless absolutely necessary—for example, if

- disease is suspected, for requeening, or to add or take off supers
- on a very windy or cold winter's day
- when it is raining
- at night

BEFORE GOING TO THE APIARY

The following list of equipment and supplies should be available before departing for the apiary. Although some of these items will not be needed during every trip to the apiary, it may be prudent to keep them near at hand (in the car or in the apiary shed):

- extra hive tools
- extra smoker
- matches
- dry fuel for smoker
- water to wash sticky hands, quench thirst, and put out smoker
- can or jar of fresh syrup for emergency feeding
- plastic spray bottle
- extra frames
- extra hive bodies, outer covers, inner covers
- division screen
- container to collect scrapings of wax or propolis
- queen excluder
- hive diary
- pencil and pen
- burlap or cotton sacking, to protect uncovered supers from robbing bees
- newspaper to unite hives
- hammer and nails for repairs

- tape and screen to close holes and cracks
- pruning clippers and sickle to keep vegetation under control
- bee medication
- bee-sting kit or other medications for the beekeeper

THE HIVE DIARY

Methods of keeping track of the condition of each hive vary. Some beekeepers use a system of bricks or stones placed on top of the hives in some code to tell the queen's age, swarming tendencies, or the like. But since the stones can be removed or the code forgotten, other methods giving more precise information should be used.

A sheet of paper stapled or tacked to the underside of the outer cover is a good place to keep records. Similarly, a hive diary can be kept and filled out each time the hives are worked.

By referring to the diary before going to the apiary, the beekeeper will be less likely to forget any needed supplies or equipment. Every time a particular hive or group of hives is worked, the following information should be noted or sketched in the hive diary:

- date
- weather conditions (wind, temperature, humidity, etc.)
- colony strength: number of frames with sealed brood; number of frames covered by adult bees
- characteristics of hive (aggressive, gentle, productive)

- swarming record (how often, what time of year)
- manipulation that day (reversing, supering, etc.)
- effects of last manipulation and time elapsed (after requeening, etc.)
- hive weight gained or lost since last visit
- requeening schedule (age of queen)
- disease record
- wintering ability
- medication schedule (what type, when, for what reason)
- number of stings received and reaction

SMOKING

The use of smoke while working bees is essential. No hive should be opened or examined without first smoking the bees. A few periodic puffs of smoke will help keep the bees under control, but bees that are oversmoked might become irritated.

When bees are smoked, they seek out and engorge honey or nectar in the hive. Bees with full stomachs are less prone to sting. When the hive is first opened, the guard bees—which are sensitive to hive manipulations—release an alarm pheromone to alert other bees; when many bees are releasing this pheromone, the beekeeper may also detect this alarm odor, which is similar to the odor of banana oil. The alarm pheromone causes the bees to react aggressively to protect the hive from "intruders." Smoke directed from the beekeeper's smoker into the entrance of the

hive will mask the initial release of the alarm odor and, as a consequence, the other bees will be more likely to continue their routine hive duties rather than assume an aggressive stance.

Smoke can also be used to drive bees away from or toward an area within the hive. It is also used to mask the alarm pheromone after one has been stung. Since the gland which releases the alarm pheromone is at the base of the sting, after one is stung some of this pheromone "tags" the area; other bees who detect this signal may also sting the tagged area. Clothing and bee gloves that have been stung should also be smoked (and washed occasionally) to mask the alarm odor.

The bigger smokers should be purchased since they are easier to light than the smaller ones, burn longer, and are less likely to fail when they are needed most.

Lighting the Smoker

One should become thoroughly familiar with the smoker before using it at the apiary. It is a good idea to practice lighting it a few times before using it near bees. All beekeepers have their favorite fuel and may use it exclusively. The best fuel to use is the fuel that works best for you and that is readily accessible. Some commonly used fuels are:

- | | | |
|---------------|------------------|------------|
| -straw | -cedar bark | -cardboard |
| -leaves | -twigs | -rags |
| -rotted wood | -burlap | -sawdust |
| -sumac bobs | -wood shavings | -corn cobs |
| -pine needles | -cotton stuffing | |

Synthetic materials should not be used since they may give off a toxic smoke when burned; newspaper should not be used as the sole fuel since the ash is too big and could burn the bees.

To light a smoker:

- Drop a small amount of blazing fuel (even a small piece of newspaper) to the bottom of the smoker.
- Puff the smoker and slowly pack it with unburned material.
- Puff hard until it stays lit.
- Once it is going, put a handful of grass or green leaves on top of the fuel to cool the smoke and catch hot ashes.
- Do not pack it too tightly and keep filling it periodically.

After finishing work in the apiary:

- Place the hive tool(s) in the opened smoker and puff a blaze to sterilize the tools.
- Empty the remaining fuel and ashes onto dirt or pavement and drench them with water. Some beekeepers stuff rags into the nozzle of the smoker to suffocate the fire so that the fuel may be reused later.
- Make sure the fire is out and the smoker is cool before putting it away and *never* leave a lighted smoker in a vehicle.
- Sand both the smoker and the hive tools periodically.

OPENING THE HIVE

The general method used by most beekeepers to open and examine a hive is outlined below. The procedure may vary somewhat, depending upon the number of supers on the hive and the purpose of the examination:

- Approach the hive from the side or back.
- Do not stand in front of the hive at any time, since the flight path of incoming bees will be blocked.
- Puff some smoke into the entrance (being sure it gets inside) and wait 30 seconds so the bees can begin to gorge honey.
- Gently pry or take off the outer cover and direct a few puffs of smoke through the oblong hole of the inner cover, and again wait 30 seconds for the bees to gorge honey; then gently pry off the inner cover. If an inner cover is not used on the hive, puff some smoke under the outer cover as you take it off and wait 30 seconds.
- Place the inner cover near the entrance so clinging bees can reenter the hive.
- After the covers have been removed, smoke the bees down from the top bars of the frames; smoke must be used judiciously—too much will cause the bees to run in every direction, making your work more difficult and decreasing the likelihood of finding the queen.

Examining a Hive

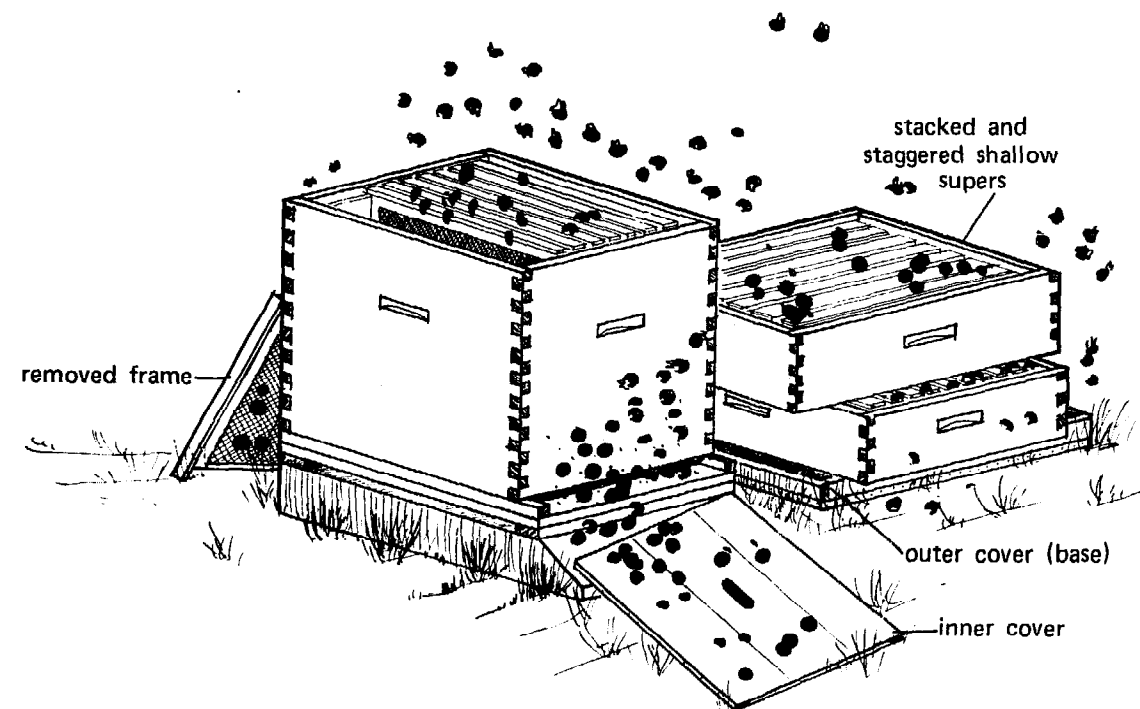

- Use the outer cover (underside-up) or a spare hive stand as a base for stacking supers as they are removed from the hive (see illus.).
- Throughout the examination, smoke the bees as needed to keep them out of your way and to keep them from getting squashed.
- The purpose of the examination will dictate whether to first remove all supers above the bottom one or whether to work from the top down during your inspection.
- Each time a super is pried off, puff a bit of smoke onto the super below.
- If the hive is very populous, it is best to start by examining the bottom-most hive body, after stacking all other supers on the upturned cover nearby (give them an occasional puff of smoke as you work). If you were to begin by working at the top, the bees smoked from successive operations on the upper supers would crowd to the lowest super—making it very full by the time you reach it.
- Wherever you decide to begin your examination, smoke the bees off the top bars and down between the frames; gently pry up the frame closest to you.
- You may set the removed frame against the back of the base hive body, out of the sun and where it won't be kicked or jarred; or place it in an empty hive body.
- As each frame is examined, hold it

vertically over the hive; in this way, if the queen is on the frame she will not drop onto the ground.

- Continue to examine each adjacent frame until your objective is completed.
- Frames should be returned to their original positions and spacing unless you are adding frames of foundation, honey, drawn comb, brood, or eggs.
- If brood and eggs are separated from the broodnest, the brood might become chilled, and the bees will have a hard time maintaining the proper temperatures if the broodnest is expanded too much.
- When replacing supers, the bees in the super below will be milling on the top bars and rims; smoke the bees down so they will not get crushed as you replace the supers.
- Whenever possible, scrape excess propolis and *burr comb* (comb not in the proper place) from the frames with a hive tool; the extra wax can later be melted down (see *PRODUCTS OF THE HIVE: Beeswax*).

WHAT TO LOOK FOR

In the spring the colony must build in strength in order to achieve the peak population of 40,000 or more that is necessary to secure a good honey crop. The beekeeper should be able to verify that:

- a queen and/or eggs are present
- there are adequate food stores

(pollen, honey, or stored sugar syrup)

- the brood pattern is compact for both uncapped (larvae) and capped (pupae) brood

The beekeeper should also check for, and take measures to correct, the following adverse conditions:

- queenlessness
- queen cups and/or queen cells (either supersedure or swarm cells)
- amount of drones and drone cells
- presence of a failing queen or a drone-laying queen
- presence of laying workers
- leaking feeders
- crowded conditions (give extra hive bodies)
- overheated conditions (provide shade or ventilation)
- diseases and pests
- robbing activities
- bottom board clogged by bees, debris, or propolis (clean off or replace)
- wet, damp, or rotting bottom board (replace)
- dwindling populations
- broken combs or frames
- cracked or broken equipment
- obstruction in front of the entrance (weeds, grass)

FINDING THE QUEEN

The queen's presence and the extent of her activity can be established without finding her. If one finds brood frames with a concentrated pattern of capped worker cells, frames mostly filled with eggs or larvae (uncapped brood), or a combination of both, her presence and quality are indicated.

If it is necessary to find her, the hive should be opened gently (as outlined in *WORKING WITH BEES: Opening the Hive*) and the outermost frame should be removed. She will seldom be found on frames with just honey and pollen or on frames with capped brood; she will most likely be found on or near frames containing eggs and uncapped larvae.

The queen can often be spotted in the midst of her encircling "attendants." When a queen moves slowly along the frame from cell to cell, the other bees will clear her path, but the circle will be reformed when she pauses (see illus.).

If the queen must be found—whether before requeening, to kill her before uniting colonies, to mark her or clip her wing, or just to satisfy the need to see her—but cannot be located within 15 minutes or without disrupting the entire hive, it may be helpful to use the following method:

- Place a queen excluder between the two brood chambers (usually the two lower hive bodies).
- Five days later the queen will be in the hive body whose frames contain eggs. Since all eggs hatch in three days, the brood chamber from which she was excluded will have no eggs.

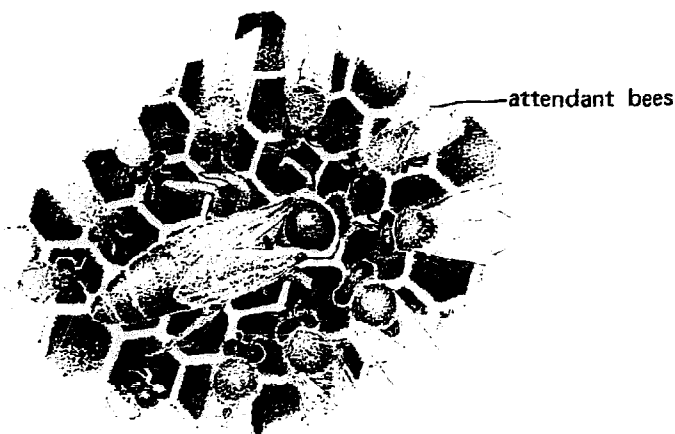

BEE TEMPER

Good Disposition

To minimize the likelihood of being stung, it is best to work the hive on days when most field bees are foraging.

Generally, bees are gentlest:

- in the spring, when populations are low and a honeyflow is on
- during a good honeyflow
- on warm, sunny, calm days
- when populations are low, as with package bees
- when bees are well-gorged with food, as with a swarm or package bees
- between late morning and early afternoon (roughly between 10 a.m. and 2 p.m. depending on season and time zone)

Irritable Disposition

Bees are more prone to sting when most of the foragers are in the hive. The reason for the foragers not being out is related to conditions outside the hive (usually weather). The following conditions are those under which bees are more likely to sting:

- in the fall, after the honeyflow
- during a poor honeyflow when there is little food coming in
- when disturbed by skunks or other pests
- before a thunderstorm

- on cool, wet, cloudy days
- on hot, sultry, humid days
- on windy days
- in the early morning or the late afternoon or evening
- when queenless
- when laying workers are present
- when many bees are killed by improper handling
- when the hive or a hive part is jarred
- when diseased
- in reaction to pungent hair oils, lotions, or perfumes
- when examined without using smoke
- when honey is removed and robbing activities are stimulated

WHAT TO DO WHEN STUNG

Once a worker bee does succeed in piercing the beekeeper's skin with the barbed lancets of its sting, the bee cannot withdraw the lancets from the skin. As the bee struggles to free itself, the poison sac attached to the lancets is ripped from the bee's abdomen. This means that the bee will ultimately die; and having left most of its sting imbedded in the victim's tissue, it will obviously not be able to sting again before it dies.

Other stinging insects have either smooth lancets or lancets with ineffectual barbs; they can therefore withdraw that portion of the sting and repeatedly reinsert it. The queen honey bee has such a sting, but she rarely if ever directs it at victims other than rival queens.

The sting should be scraped off with a fingernail or hive tool as soon as possible to minimize the amount of venom pumped into the wound. Start to scrape the skin with your nail about an inch away from the sting and continue scraping through the sting; it will pull out easily. One should never attempt to remove the sting by pinching it, since the pinching action will squeeze the poison sac, forcing more venom into the victim's tissue.

Since an alarm pheromone accompanies a sting, other bees are likely to sting in that vicinity; smoke should be applied to the area of the sting to mask the alarm odor.

TREATMENT OF BEE STINGS

Local Reaction

For local reactions, there is very little an individual can do except to relieve the itching. Since the sting barbs are so tiny and the puncture so small, no treatment will be effective in reducing the amount of venom other than the prompt, proper removal of the sting structure.

Every beekeeper has a favorite treatment for bee stings. The treatment does not "cure" the sting but gives a different sensation to the area, and thus it takes one's mind off the momentary pain. The following items are often used to relieve bee stings:

- bee sting treatment kits
- ice packs or cold water
- vinegar
- raw onions rubbed on the area

- baking soda
- ammonia
- meat tenderizer, as a paste
- mud

All of the above treatments work best if applied immediately after being stung. Immediate application of these items, however, is usually impossible if the beekeeper gets stung away from home or through a bee suit.

To give relief to the itching red welt that appears following a bee sting one might apply calomine lotion or other insect bite/poison preparation, or hot water.

Systemic Reaction

Persons who break out in hives or have difficulty breathing after being stung by a honey bee may be allergic to bee venom. For all systemic or general allergic reactions, immediate medical aid is strongly recommended even though some medication may be at hand.

Bee sting reaction medication can only be obtained with a prescription. The drugs commonly prescribed are an antihistamine and adrenaline. Here are some examples:

Oral:

- Isoproterenol Hydrogenchloride** (Isuprel Sublingual; three-year shelf life) in 10 mg pills; placed under the tongue, followed by:
- Diphenhydramine Hydrogenchloride** (Benadryl; four-year shelf life) in 50 mg pills; an antihistamine

*generic name of drug

Injected:

—*Anakit*[®] or other insect sting kits are available with a prescription and include a syringe filled with *Epinephrine* (Adrenaline), with instructions for it to be injected under the skin (subcutaneously). Keep refrigerated and do not use if cloudy; do *not* inject directly into veins.

Aerosol:

—An aerosol bronchial applicator, as for asthma sufferers, will offer quick relief of breathlessness as a result of a bee sting. The dosage of two puffs should be repeated after 15 minutes.

Although the above information provides an outline of what might be done for systemic or general allergic reactions to bee stings, exact and precise medical information should be strictly adhered to. No one should attempt to self-diagnose their response to bee stings or to prescribe medications for themselves or others but should instead seek the advice of a physician.

(A discussion of bee sting reaction physiology is included in Appendix A. See also *REFERENCES: Bee Sting.*)

UNEXPECTED OCCURRENCES

When working with bees, situations sometimes arise for which the beekeeper is not prepared. These are some of the more common ones:

—*If a bee gets in your veil:* kill it quickly, before it stings you on

the face; or walk behind a tree or bush, trying not to let other bees follow you, and remove the veil quickly to release the trapped bee.

—*If your smoker goes out:* cover exposed supers with extra outer cover(s) or cloth to prevent robbing and relight the smoker.

—*If you are chased by a lot of bees:* blow smoke on yourself and walk casually behind bushes or trees; be sure your smoker does not throw out flame, otherwise your clothing might ignite. Bees are very myopic; they see movement (like fleeing bodies) very easily but are confused if many objects like branches or leaves are between them and their target.

—*If the queen is balled* when released directly into a colony of package bees or when introduced into a hive that is being requeened or to one which already has a queen (in these cases the bees consider her foreign and commence to surround or "ball" and attack her) or when the hive is roughly handled do one of the following:

—Cover the hive quickly and hope for the best.

—Break up the ball with smoke or water and cage the queen; reintroduce her using the Indirect Release Method (see *STARTING FROM PACKAGES* and *SPECIAL MANAGEMENT PROBLEMS*).

—Break up the ball and spray the

queen with syrup, then place her on a frame of uncapped brood.

—Requeen.

Notes

Starting Bees from Packages

ABOUT PACKAGE BEES

A package of bees is a screened box containing several pounds of bees, a laying queen in a separate cage, and a feeder can of sugar syrup (see illus.). The package is prepared by a bee breeder or package dealer who opens a hive, isolates the queen, and shakes the bees clinging to the frames into a funnel which is attached to the circular opening of the screened box. After the desired number of bees (measured in pounds) has been shaken into the package, a newly mated queen taken from a queen-mating box is enclosed in a queen cage and placed in the package, usually suspended next to the circular opening for the feeder can. The feeder can containing sugar syrup is then inserted into the circular opening, a lid is placed over it, and the package is ready to ship.

The bees in the package now have a foreign queen (not their own), but since she is caged, they are unable to harm her. While in transit, the bees will come to accept her as their own.

There are many methods used to install bee packages, the basic differences being in the manner in which the queen is released from her cage. In the *Indirect Release Methods*, the queen remains caged and the bees are allowed access to a candy plug which they must remove in order to release her. This method simply delays the queen from being freed among the other bees for a few more hours or days and increases the likelihood of their accepting her.

In the *Direct Release Methods*, the screen or cork is removed from the queen cage, allowing the queen to walk out onto the top bars of the hive among the other bees or into the entrance. When the queen is released directly, the bees may still not be fully acquainted with her and, as a consequence, they may form a tight ball of bees around her and begin stinging and tearing her apart. This process, called *balling the queen* may result in the queen's death or permanent injury (see *WORKING WITH BEES: Unexpected Occurrences*). Combinations and variations of the Direct and Indirect Release Methods are covered in *STARTING BEES FROM PACKAGES: Installing Packages*.

Package of Bees

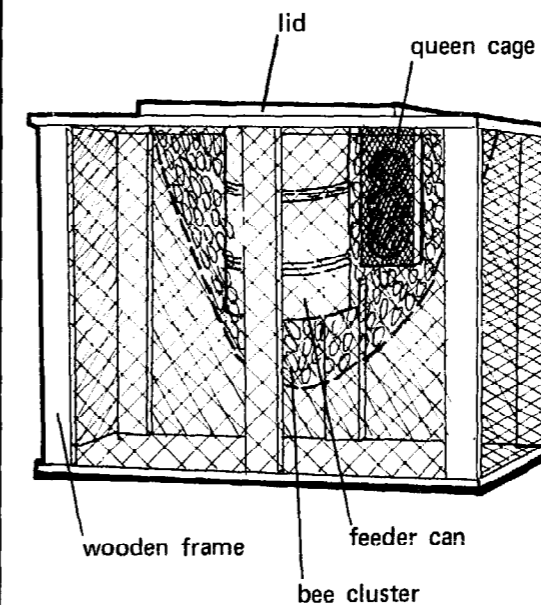

ORDERING PACKAGES

If possible, packages should be ordered directly through the breeder (other beekeepers may be able to provide a list of reliable sources), or they can be obtained through a local bee supply house. Advertisements by local dealers may be found in publications of state beekeeping organizations, and beekeeping journals like the *American Bee Journal*, *Gleanings in Bee Culture*, and the *Speedy Bee* include advertisements for almost all package bee dealers (see *REFERENCES: Journals and Publications*).

A week before the bees are expected, call the post office and leave a phone number where you can be reached so the postal clerks can contact you when the bees arrive. If the bottom of the package has well over an inch of dead bees, have the postal clerk or express agent sign a Bad Order Receipt; this may allow the shipper to collect from the express agency. If the package is guaranteed and the queen is found to be dead and/or the package has well over an inch of dead bees, the shipper should be notified and asked when replacements can be expected.

If the queen is dead, replacement must not be delayed or some workers will undergo ovary maturation and begin to lay eggs. Laying workers can only produce drone eggs and, thus, the colony would be doomed (see *SPECIAL MANAGEMENT PROBLEMS: Laying Workers*). If the queenless package bees can be provided with a frame or two of eggs

and uncapped larvae from an established hive, they will raise a new queen.

WHEN THE PACKAGES ARRIVE

The bees may be buzzing loudly and wandering all over the package when it arrives. They are not "mad" or ferocious. As soon as possible, the package should be placed in a cool (not cold), draft-free, quiet, and darkened area, and the bees should be fed heavily with sugar syrup. They will soon become calm. Feed the bees liberally with sugar syrup from a spray bottle (but do not soak them) or sprinkle the syrup on the screened sides of the package. Some beekeepers brush the syrup on the screen, but this can injure the bees—many of whom will have their tongues and feet protruding through the screen.

The syrup, which should consist of a mixture of one or two parts white sugar to one part warm water, should be prepared before the bees arrive (see *FEEDING BEES: Sugar Syrup*). The syrup should be medicated with Fumidil-B, sulfathiazol, or terramycin TM25 or TM50 (see *BEE PESTS AND DISEASES: Chemotherapy*).

Install the package in the late afternoon; if the weather is unusually cold, wait for the weather to improve (but do not wait more than a few days), and continue the feeding.

All equipment should be readied and in place well before the bees' arrival; equipment should include a deep hive body with ten frames of foundation or

drawn comb, a bottom board, inner cover, outer cover, and entrance cleat (see *EQUIPMENT AND BEEKEEPING SUPPLIES: Basic Hive Parts*). Hive entrances should be closed until the bees are installed to prevent mice from entering the hive and damaging the comb.

INSTALLING PACKAGES

Indirect Release Method I

The bees should be fed with syrup almost continuously for the last half hour before the package is installed so the bees will remain calm (see *FEEDING BEES: Sugar Syrup*). Follow this procedure:

- Take the package to the pre-assembled hive.
- Shake or jar the package so the bees drop to the bottom of the package.
- Spray the bees with syrup or water to coat their wings, but do not soak them.
- Remove the lid, exposing the top of the feeder can and the queen cage;
 - if the queen cage is attached to a metal tab adjacent to the feeder, remove the cage and replace the lid.
 - if the queen cage is hung from a wire or piece of screen next to the feeder, grasp the wire tab to keep the cage from falling into the package; remove the feeder can and then the queen cage; replace the lid to contain the bees.

Indirect Release Method I

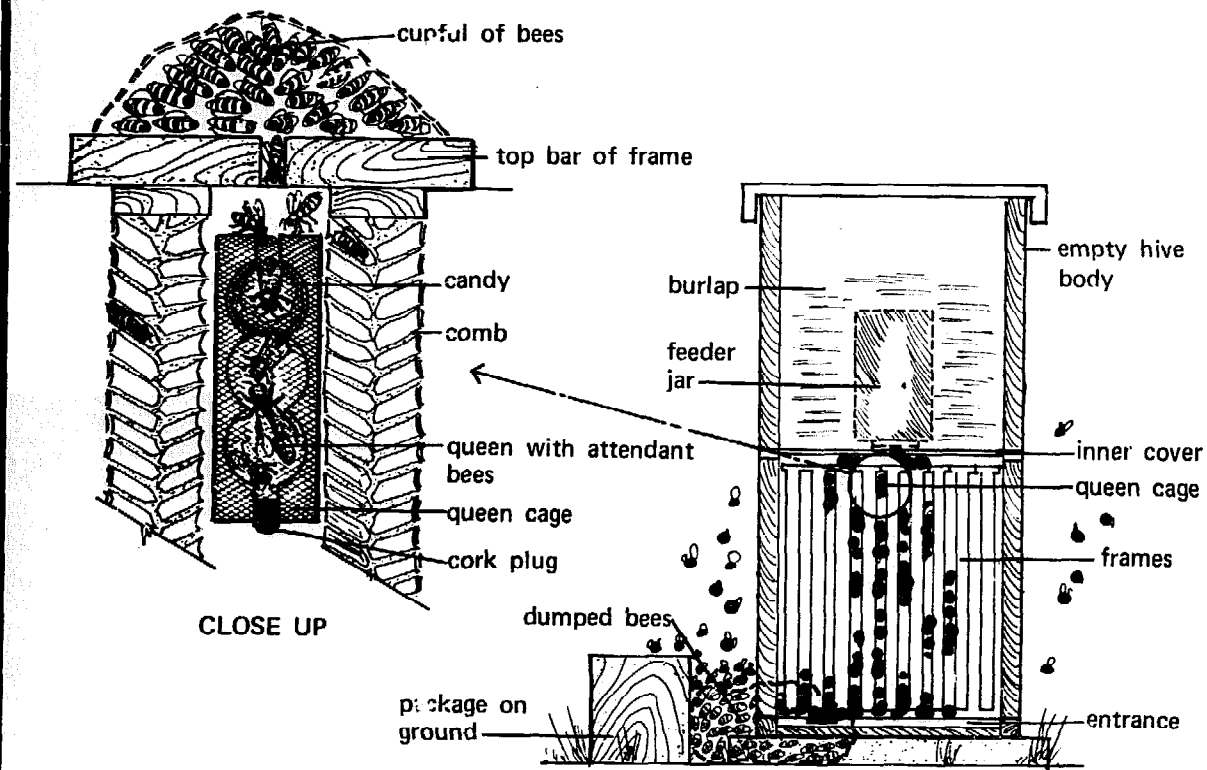

- If the queen is alive, remove the cork from the end of the queen cage which contains the white candy; scrape and remove most of the candy plug with a nail, leaving a 1/4 to 1/8 inch (3-5 mm) candy barrier. The candy will delay the queen's release, helping to insure her acceptance by the other bees.
- If no candy is present, after removing the cork, plug the hole with a midget marshmallow.
- Suspend the queen cage between the fifth and sixth frames of the hive, screen-face forward and candy-end up (see illus.); the cage should not be placed directly under the oblong hole of the inner cover so as to avoid syrup dripping on the cage.
- Remove the package lid and shake approximately a cupful of bees onto the queen cage; replace the package lid.
- Place the inner cover on the hive, rim-side down, to allow extra room above the top bars; invert the feeder can or jar over the oblong hole of the inner cover; invert the jar so that initial drippings will fall on the ground away from the hive, otherwise syrup dripped on the hive or inner cover may invite robbing bees; if the feeder leaks, get another (see *FEEDING BEES: Friction-Top Jar or Screw-Top Pail*).
- Place an empty hive body over the inner cover and feeder can; place

the outer cover on top.

- Again spray the remaining bees in the package with syrup.
- Remove the package lid and shake a third of the bees out in front of the hive allowing them to walk into the entrance. However, if it is cold, use the Direct Release Method instead.
- The freed group of bees will soon begin to *scent* (their heads will face the entrance, abdomens raised, wings fanning), releasing an odor or pheromone to attract other bees to the hive.
- When the bees begin to enter the hive rapidly, shake the rest of the bees from the package slowly to keep the bees from drifting in front of the hive.
- After most of the bees have entered, partially block the entrance of the hive with a reducer cleat or with grass; leave the entrance partially blocked for two months (replacing grass when needed) to discourage robbing.
- Leave the package near the hive entrance overnight, open-end up, to let any remaining bees escape into the hive.
- Check to see if queen is released after one week.

For the next 14 days, do not disturb the colony except to replace syrup in the feeder can. When replacing the syrup, have a lit smoker ready and first blow smoke into the empty hive body at the top. Smoke around the feeder, then tilt

up the empty feeder, direct smoke into the oblong hole of the inner cover to move the bees away, place a full feeder on top, and close the hive.

Open the hive on the 15th day after installing the package, weather permitting, (see *WORKING WITH BEES: General*) using smoke as needed. If one or more of the frames shows a fairly compact brood pattern (capped cells and open cells full of eggs and larvae), all is well. Close the hive and leave it undisturbed for another week. During the next visit to the hive, remove the queen cage and refill the feeder; continue feeding the colony until the first major honeyflow. Two months after installing the package, add a second hive body with frames if the first is full of drawn comb and brood. If there is no major honeyflow and the new hive body contains frames with foundation only, feed the bees with syrup. If the bees are not fed they will chew the foundation.

Advantages:

- excellent chance of queen being accepted
- no additional trips to apiary needed
- syrup located in vicinity of bees and queen, so likelihood of starvation is slight
- easy way to feed medicated syrup
- bees will not leave hive if queen is caged and unable to fly

Disadvantages:

- some drifting occurs
- an extra hive body is needed
- may take a little more time than other methods
- have to remove queen cage at a

later date

- egg-laying delayed since queen is not immediately released

Indirect Release Method II

Follow the same procedures as in the first method as far as removing the queen cage, and then follow this sequence:

- If the weather is cool, place the queen cage in your pocket, screen side away from your body; if the weather is warm, place the queen cage in the shade.
- Remove four or five frames from one side of the hive body.
- Suspend the queen cage between two frames, after scraping away some of the candy plug (as in Method I).
- If the weather is cool, shake some bees onto the queen cage to keep her from becoming chilled.
- Place the entire package in the vacant space in the hive (where the frames have been removed), being sure that the open-end of the package is up to allow the bees to escape (see *illus.*).
- Replace the inner cover, rim-side down, and feed the colony as described in the previous section, with sugar syrup from a feeder can or jar (see *FEEDING BEES: Sugar Syrup*).
- After placing an empty hive body on top and covering it with the outer cover, reduce the entrance with a cleat or with grass (as in Method I).

Indirect Release Method II

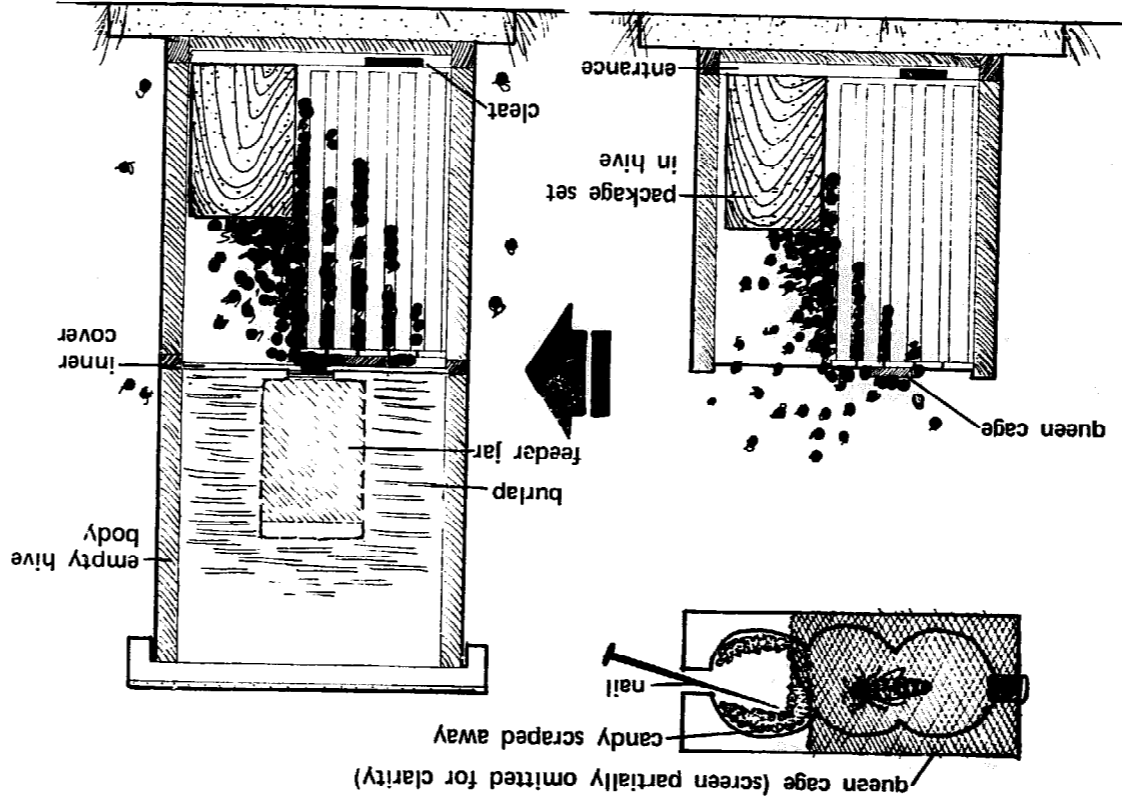

Advantages:
 —inspect the hive to check the queen and to refill the feeder can as previously outlined.
 —excellent chance of queen being accepted
 —bees disturbed less than with Method I
 —less drifting
 —easiest for beginners

Disadvantages:
 —additional trips must be made to remove the queen cage, remove package, replace frames
 —egg-laying delayed since queen's release is delayed
 —bees may build comb in the package, not in the hive proper and the queen might start to lay eggs in these combs
 —extra hive body needed

Direct Release Method

Follow the first procedures as outlined for the Indirect Release Method I as far as removing the queen cage, and then follow this sequence:
 —if the weather is cool, place the queen cage in your pocket, screen side away from your body; if it is warm, put the cage in the shade.
 —Remove four frames from the middle of the hive.
 —Remove the lid from the package and shake all the bees onto the bottom board in the vacant space.
 —Spray the bees with syrup to re-

duce their flying ability, but do not soak them.

- Dip the queen cage in syrup, or spray it, so that the queen will not fly off when released; do not dip it if the weather is cold.
- Carefully remove the screen from the queen cage and lower the cage into the hive near the bees (see illus.).
- Allow the queen to walk or drop gently on top of the bees.
- As soon as the pile of bees disperses, carefully replace the frames, taking care to avoid crushing the bees.
- Replace the inner cover and follow the rest of the steps in the Indirect Release Method I.

Advantages:

- queen released and can start to lay sooner
- easiest, fastest method; complete in one operation
- no return trips to apiary needed except for feeding

Disadvantages:

- extra hive body needed
- queen could be killed or balled
- bees could leave (abscond) with free-flying queen
- queen could fly away during installation (taking bees with her) or be otherwise lost
- queen could be superseded
- some bees and/or queen could be injured or killed when frames are replaced

Direct Release Method

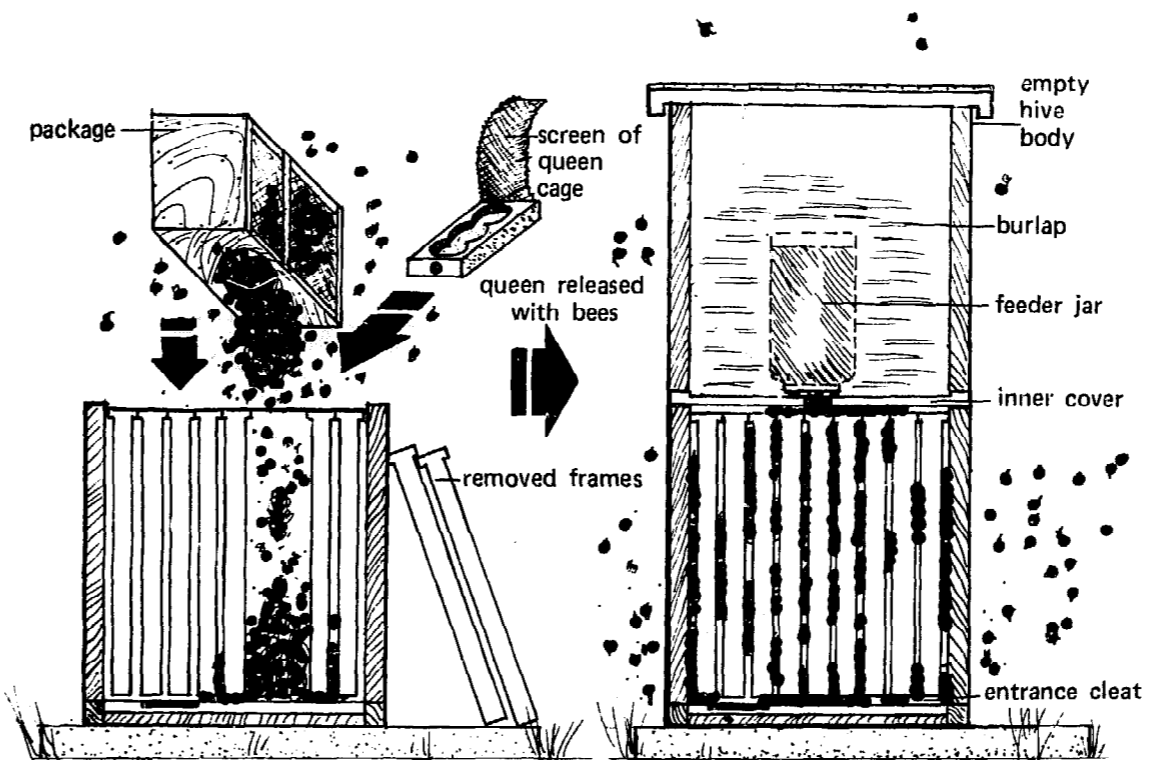

- drifting occurs
- any dead bees in package are also shaken into the hive, making extra work for bees to remove them

Combination Method

The Combination Method follows the same sequence as the Direct Release Method, except that the queen remains caged and is released by an Indirect Release Method. In other words, the bees are shaken directly into the hive, but the queen is kept caged so the bees will have to free her. The advantages of this Combination Method are the same as for the Indirect Release Method I; the disadvantages are the same as for the Direct Release Method, except for references to the queen.

REASONS FOR PACKAGE FAILURES

Bee hives started from packages sometimes fail after they are installed.

Reasons for failure include:

- queen has been superseded (due to nosema disease or other reasons)
- queen is unmated or poorly mated
- queen is balled as a result of too many disturbances of the hive by the beekeeper (especially during first ten days after installation)
- weather has been too cold for bees to forage or obtain syrup due to location or type of feeder
- bees have starved
- disease
- bees have left the hive

Feeding Bees

GENERAL

Bees should be fed under the following conditions:

- when no natural honey or pollen is available (in late winter or early spring) in order to stimulate brood rearing
- when colony is in danger of starving
- when it is necessary to supply medication (chemotherapeutic agents)
- when installing a package or hiving a swarm for the above reasons, as well as to stimulate wax glands when these bees or others are given foundation to draw
- when requeening
- when rearing queens and no natural honeyflow is on

Bees can exhaust their own food stores or for other reasons be unable to build up existing stores and eventually deplete them. In either case, the colony will be hard-pressed to stay alive and should be fed. If this situation occurs during the flowering period, the colony may continue to exist on a day-to-day basis, but it will surely be weakened and—should an interval of inclement weather set in—may perish. If stores are exhausted in the fall, winter, or early spring, the colony will die.

Stores may be reduced in these ways:

- the beekeeper removes too much honey, particularly in the fall
- the bees eat up the last of the winter food in late spring
- the number of field bees becomes reduced due to spring dwindling (see *GENERAL SEASONAL MANAGEMENT: Spring Dwindling*)
- the bees' food consumption increases when egg-laying resumes in midwinter, to provide heat and food for brood
- when an expected honeyflow fails to materialize; or inclement weather sets in at the time of the honeyflow to prevent bees from collecting fresh food; or a plant fails to yield expected food

When colonies are in a condition where starvation is imminent, the bees must be fed to insure their survival. The various methods of feeding bees with sugar syrup, dry sugar, honey, and pollen and its substitutes are discussed in this section (see *REFERENCES: Feeding Bees*).

SUGAR SYRUP

One gallon of sugar syrup (2:1, sugar:water) will increase the food reserves of a colony by about 7 pounds. The following proportions (by volume) of sugar:water should be fed depending on the season and the purpose for the feeding:

- 1:1, sugar:water, for spring feeding
- 2:1, sugar:water, for fall feeding
- 1:2, sugar:water, to stimulate brood rearing (make only two holes in the lids of the gravity feeders so the bees will only be able to obtain small amounts over an extended period of time; this effect will be similar to a light nectar flow)

Use white, granulated cane or beet sugar only; *never* use brown or raw sugar, molasses, or sorgum since these contain impurities and can cause dysentery in bees.

Mix the desired proportions of sugar and water and stir adequately until all the sugar is dissolved. Warm water from the faucet is hot enough to dissolve the sugar; or mix the sugar with hot, not boiling, water that has been heated over a stove. Never let the sugar-water solution boil over direct heat since syrup that is burned, or caramelized, will cause high bee mortality. Heating the mixture over steam or in a double boiler will prevent caramelization.

To prevent fall syrup from crystallizing, some beekeepers add cream of tartar (or tartaric acid) to the solution of sugar and warm water. Tartaric acid

breaks down the sugars but may be detrimental to bees. Bees should be fed early enough in the fall so that the sugar has time to cure, but if this is not possible, add one teaspoon tartaric acid for each 20 to 30 pounds of sugar syrup.

Screw-top Jars and Friction-top Pails

One of the best ways to feed bees at almost any time of the year is with a five or ten-pound glass jar or friction-top tin pail turned upside-down over the top jars of the hive or over the oblong hole of the inner cover. The lid is perforated with a few small holes so the bees can insert their tongues into the holes to withdraw the sugary solution.

Plastic jars often collapse after they are filled and inverted, so their use is not recommended. Tin pails become rusty, are difficult to clean, and are expensive to purchase. Glass jars, on the other hand, can often be obtained free of charge and, although breakage does occur, they are easier to clean and inexpensive to replace, and one can readily see if they need to be refilled.

Use a shingle nail, or a 3 or 4 penny nail (1/16 inch diameter, 1.6 mm), to punch 6 to 10 holes in the lid (after removing the cardboard washer from a screw-top lid). At the hive, first invert the jar or pail so drippings will fall in some container or on the ground, rather than onto the hive, so as not to encourage robbing; as soon as the dripping stops, place the feeder over the top bars near the cluster if the colony is weak; otherwise, place it over the oblong hole of the

inner cover. Place an empty hive body around the feeder, and replace the outer cover.

The syrup will not leak as long as the holes are not too large and the feeder is level; if there is empty drawn comb in the hive, the bees will remove the syrup from the feeder and store it in the comb below.

Division-board Feeder

The division-board feeder is a frame-size container which can be inserted in place of a frame within a deep hive body. Feeders of this type have some kind of flotation device or a strip of screen which allows the bees to reach the syrup without drowning. Division-board feeders are made with masonite, wood, or plastic and usually have styrofoam or wood floats.

Some beekeepers keep one division-board feeder in each deep hive body. However, on cold days, bees in weak hives will be less able to obtain syrup when this type of feeder is used unless it is located near the cluster. If the weather continues for a long duration, the bees may be unable to move to the feeder and could starve.

Miller Feeder

Another type of feeder, called the Miller feeder, is composed of two aluminum or plastic pans fastened together and hung within or otherwise attached to an empty shallow super. A bee space between the two pans allows the bees to crawl up and over the sides to feed. A

Screw-top Jar Feeder

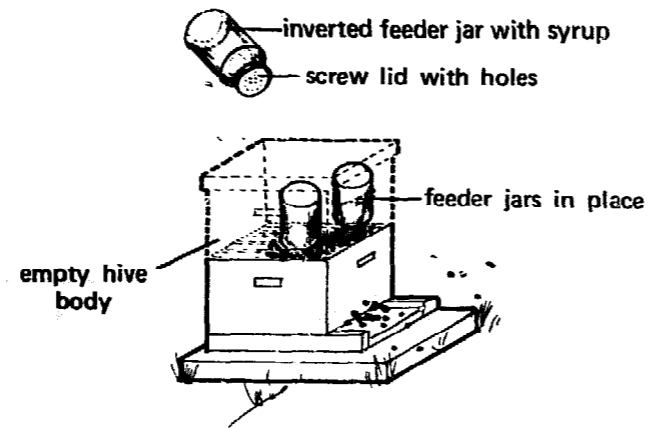

Miller Feeder

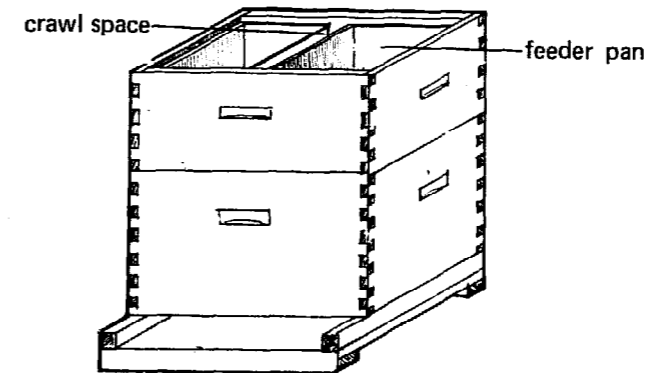

MILLER FEEDER IN PLACE

Division-board Feeder

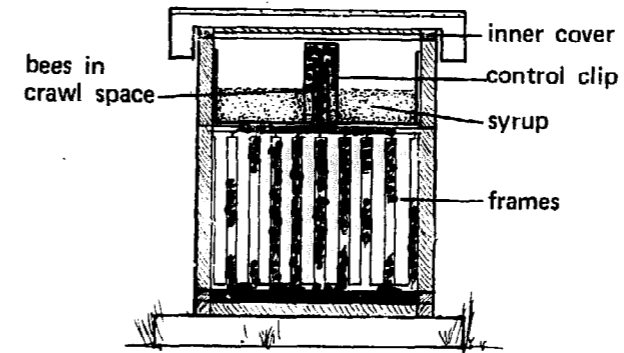
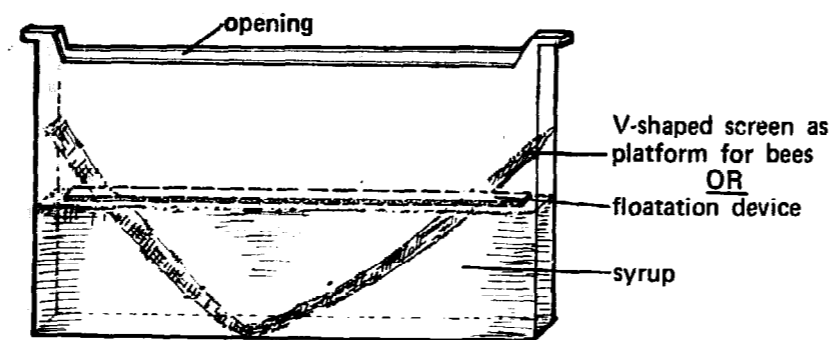

CROSS-SECTION

Filling Empty Drawn Comb

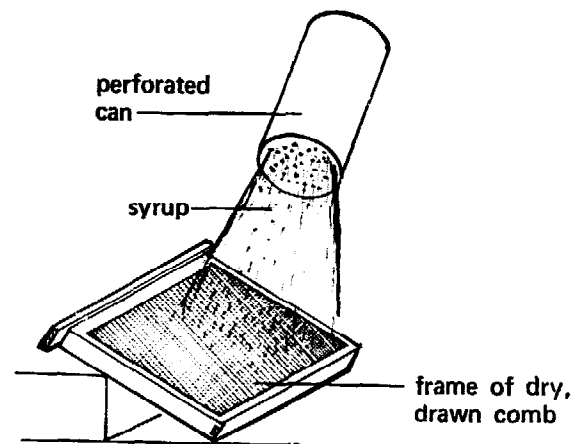

Feeding Dry Sugar

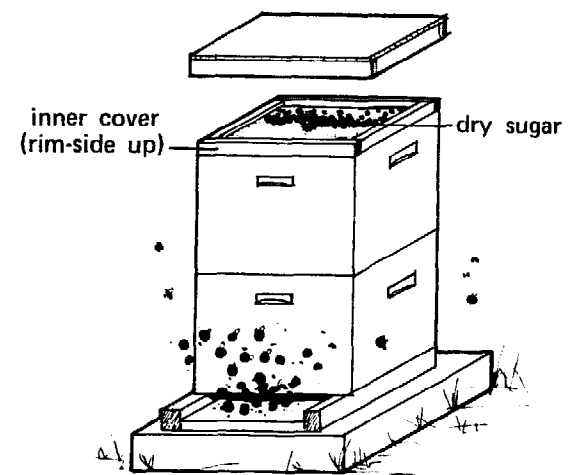

Boardman Feeder

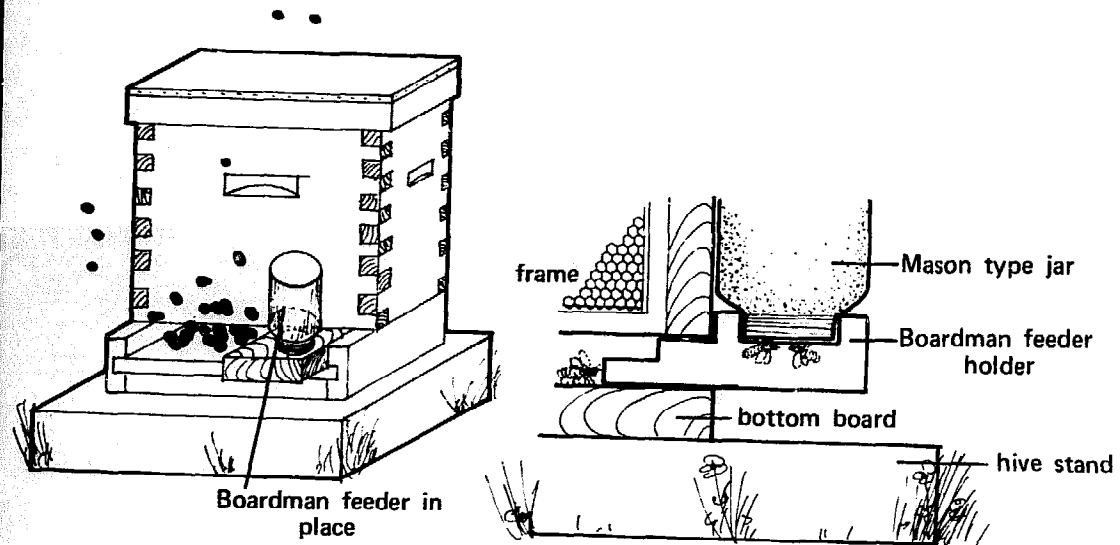

Rim Feeder

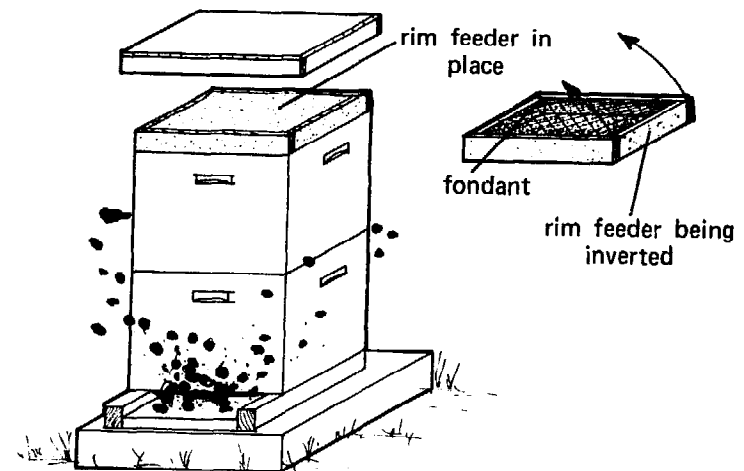

control clip allows the bees to cling to its sides without drowning in the syrup; it can be placed over the crawl space (see illus.).

The Miller feeder (also called a Miller super) is placed at the top of the hive beneath the inner and outer covers; it can hold up to four gallons of syrup and can be rapidly filled or refilled. Variations on the same principle are also available. If this type of feeder is used, the super should be bee tight on the outside or else robbing may result.

Empty Drawn Comb

Frames of empty drawn comb can be filled with syrup and placed in the hive. Slowly dip the frames into a tub of syrup or sprinkle them with a sprinkler can or other device. A steady stream of syrup poured directly from a container will not fill the cells, since the air in the cells will act as a barrier to the liquid. This method can be used for emergency feeding, especially if the combs are located near or adjacent to the broodnest. As with other feeding methods, one has to look into the hive (and remove these frames) to determine whether or not they need refilling.

This method is often used when installing package bees in a hive with drawn comb. Newly hived swarms, however, should not be fed by this method. Bees in a swarm have full honey sacs and if put on drawn comb may regurgitate the contents of their sacs into these cells; if such honey contains disease spores and is

later fed to larvae, brood diseases like American foulbrood could result (see *SPECIAL MANAGEMENT PROBLEMS: Hiving a Swarm*). It is very important to ensure that any combs used for feeding syrup have no history of brood diseases.

Boardman Feeder

A Boardman feeder is a wooden or plastic holder for a quart-size mason jar. The portion of the holder's base with an entrance platform is inserted into the hive entrance. The bees can obtain syrup by crawling into the holder's entrance.

The Boardman feeder is not recommended since bees from other colonies can rob syrup from it, and this tends to encourage further robbing activity. If the weather is cold, the colony being fed will not break the cluster to reach the feeder and may starve whenever stores are low. The feeder only holds a quart of syrup and would require frequent refilling. Furthermore, in this highly exposed condition, the liquid could freeze, or the sun may decompose chemicals in the syrup which were added to medicate the bees.

DRY SUGAR

Dry, white, granulated sugar can be used as an emergency food in late spring when outside temperatures are high enough to permit the bees to obtain water for dissolving the sugar; occasionally, water that has condensed in the hive may be used by the bees for this purpose.

If the bees are unable to store honey in the early spring, feeding dry sugar in late spring, prior to a honeyflow, may help prevent starvation.

The sugar should be located as close to the bees as possible. It can be spread around the oblong hole of the inner cover (rim-side up), on the back portion of the bottom board, or on the top bars of the frames near the bee cluster. Or, the sugar can be spread over a single sheet of newspaper placed over the top bars of the hive body where the bees are located; the bees will chew through the newspaper to obtain the sugar.

Only strong colonies will benefit from the feeding of dry sugar; weaker colonies may not have sufficient numbers of bees to obtain the needed water.

FONDANT CANDY

Fondant candy can be made and fed to bees in small molds or with a special rim feeder. This method is less sloppy than feeding syrup or dry sugar, but the preparations take much longer. The basic fondant candy recipe (to feed one colony) is:

- 2 cups white sugar
- 2 tablespoons corn syrup (light), or 1/8 teaspoon cream of tartar (tartaric acid)
- 1 1/2 cups boiling water
- Combine and heat ingredients, stirring until sugar dissolves; heat without stirring to 238° F (115° C, or until a Medium Ball on a candy thermometer); pour out onto cold platter and cool until warm; beat until light and pour into molds or shallow dishes.

The molds can be inverted over the top bars near the cluster.

Another variation is to make up a rim feeder, which is a hardwood or masonite board, the size of an inner cover but with a 1-inch or deeper rim. It is filled with candy and then inverted over the cluster.

The recipe for fondant candy to fill 40 rim feeders (as given on page 360 of *The Hive and the Honey Bee*, edited by Dadant & Sons, Hamilton, Illinois, 1975) is:

- 200 pounds sugar
- 30 pounds honey
- 2 1/2 gallons water
- 1 cup vinegar
- medication (optional)
- Heat over double boiler to 240° F (116° C) for 2 hours; cool slightly and pour into rim to solidify. Each rim will have about 6 1/2 pounds of food.

HONEY

The best food of all—when properly ripened, capped, and free of disease—is, of course, a super of honey placed above the broodnest, or several frames of honey placed next to the broodnest in weak hives. Honey obtained from old combs and cappings, as well as crystalized honey, can be diluted and fed to the bees using any of the methods used for feeding syrup. Supers with frames that are "wet" or sticky after having been through an extractor can be placed above or below the broodnest or over the inner cover for the bees to clean.

But caution is urged when bees are fed with diluted honey or wet combs: the odor of honey will stimulate robbing. Therefore, feed honey or place wet combs on the hives in the early evening so that the bees will have sufficient time to remove and store it before morning. If this food is given to weak hives, reduce their entrances as a further precaution against robbers. Supers with wet combs should not be put on colonies in the late fall or winter. The entire colony of bees might move up into them and not return to stores below and, thus, they may die from starvation.

It should be stressed that store-bought honey should not be fed to bees. Honey from hives with foulbrood is sometimes extracted, bottled, and sold. There is an excellent chance that this honey contains foulbrood spores which remain viable in the honey and will likely cause an outbreak of brood disease (American

or European foulbrood). (Fortunately for us, disease spores contained in honey are not harmful to humans.) Be certain that any honey fed to the bees is free from spores that cause brood diseases.

Honey mixed with cappings, scrapings, or debris can be fed to bees if it is placed in a container above the inner cover. The remaining wax can then be recovered and melted.

POLLEN

Pollen is the male sex cell of flowers. It is also an important part of the diet for both larvae and adult bees because it supplies them with minerals, lipids, vitamins, and proteins (amino acids) and is responsible for activating many of their glands.

Bees increase their consumption of pollen in the fall. This factor, coupled with a decrease in foraging and brood-rearing activities, seems to extend the longevity of worker bees beyond their usual summer life expectancy of about six weeks.

During the brood-rearing period, the consumption of large quantities of pollen by young adult workers stimulates the head glands to secrete a milky-white, protein-rich food. This substance, called *royal jelly*, is fed in abundance to all larvae less than four days old and to queen larvae during their entire larval stage and throughout their adult lives; worker and drone larvae more than four days old are fed mainly diluted honey,

nectar, and pollen. Without pollen, bees could not manufacture royal jelly.

During the period when flowers are available, bees usually have sufficient supplies of pollen in the hive. The demand for pollen increases in the winter when brood rearing resumes and the remaining pollen stores are quickly consumed. The beekeeper, wishing to maintain or stimulate brood rearing, may have to supply bees with pollen pellets, pollen, or pollen supplements.

Trapping Pollen

Pollen can be obtained from bee supply houses or collected in a device called a pollen trap which consists of a grid and a collecting container. There is always the danger that collected pollen may contain chalkbrood, American foulbrood, or European foulbrood spores. Collect or purchase only pollen that has been obtained from disease-free colonies. When the trap is in position on a hive, bees entering or leaving the hive must pass through the grid (5-mesh per inch). The grid's dimensions will not permit a bee laden with pollen to pass through until its load (the pollen pellets) has been removed.

Ideally, a pollen trap is put on the hive during pollen flows and is kept on only for short periods. Trapped pollen must be preserved and stored carefully to prevent spoilage. Pollen loses its nutrient qualities after two years of storage. Make sure pollen is free of debris and insects before storing it.

Pollen Trap

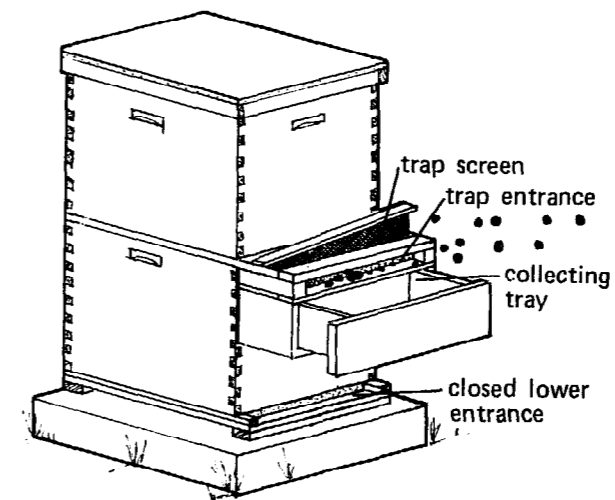

Storing Pollen Pellets

Drying Fresh Pollen Pellets. Fresh pellets collected from a pollen trap can be dried in a few days in the sun, in a warm oven, or with a lamp. The pellets are ready when they will not crush when rolled between the fingers. Store them in closed containers at room temperature.

Dry pollen may be fed directly to the bees or mixed with other dry materials. If the dry pollen is to be added to wet mixes, it should first be soaked in water for an hour.

Advantages:

- inexpensive way of preserving pollen

Disadvantages:

- less attractive to bees

Freezing Pellets. Place fresh pollen pellets in containers and store them directly in a deep freezer (at 0° F or -17.8° C) until ready to use; they will be moist when defrosted.

Advantages:

- attractive to bees
- can be used separately or added to mixes

Disadvantages:

- more costly to preserve

Sugar Storage. Pollen pellets can be preserved with sugar. Fill a container alternately with layers of pollen and white sugar, topping it with several inches of sugar. Close the container tightly and store it in a cool place. Pollen should be mixed with twice its weight of sugar (1 part pollen:2 parts sugar). Careful labeling of the container as to its amount of

sugar and pollen will ensure that proper proportions are maintained when preparing mixes with brewer's yeast and soy flour.

Advantages:

- attractive to bees

Disadvantages:

- difficult to separate pollen and sugar if you want to feed straight pollen

Methods of Feeding Pollen

Pollen may be placed into frames of empty drawn comb. Using the dry or frozen pellets:

- Fill the comb on one side of a frame with pollen pellets.
- Replace the frame in the hive overnight to allow the bees to pack the pollen; it will fall out if not first packed down by bees before repeating for other side.

Pollen may also be fed in the spring in an open, screened, covered container that lets in only bees. Place the pollen container about 10 feet (3 m) from the apiary and the bees will forage for it. Since only the stronger hives will benefit from open feeding, feed the weaker colonies separately by placing pollen on the portion of the bottom board that is covered by the hive or by pouring some around the oblong hole of the inner cover.

Notes

POLLEN SUPPLEMENT

To supplement trapped pollen, a formula of soy flour and brewer's yeast can be made or bought. When making your own formula, use the proper ingredients. The soy flour used in mixtures of pollen supplement or pollen extender must be made by the low-fat "expeller" or "screw-press" method; bees will not eat the coarsely ground soy flour used for cattle feed. The fat content should be between 5 and 7 percent. The proper kind of soy flour for bees can be obtained from most bee supply houses. Purchase brewer's yeast from a feed store—any animal-feed grade is adequate, or purchase it from a bee supply house. Different mixtures of these materials, with or without pollen, sugar, or medication, can also be obtained from dealers and supply houses.

Dry pollen supplements can be fed like the pollen pellets, when mixed in a 1:1:3 ratio (by weight) of pollen:brewer's yeast:soy flour. Some beekeepers add anise or fennel oil to attract bees, feed it with candy, or even mix it with a 5 percent dried egg yolk additive to make it more nutritious.

Supplements can be made into patties so they form a stiff dough. One-pound patties (.45 kg) are made from a 1:2:3 proportion (by weight) of pollen:hot water (or 1:1 sugar:water):soy flour. Feed one patty per week for three weeks; freeze extra patties between wax paper. Once you start a feeding regimen, keep it up or the bees might starve; provide food until they will no longer take it or until they again begin to collect ample pollen.

POLLEN EXTENDER

When no pollen is available, mix this feed as an extender:

- Combine soy flour, brewer's yeast, and sugar in a 3:1:1 ratio (by weight); mix with water to form stiff patties.
- One pound (.45 kg) of the dry extender can also be mixed with 4 cups of 2:1 (sugar:water) syrup to make several one-pound patties; make sure this is thick enough not to drip between the frames.
- One part powdered (not instant) skimmed milk can be substituted for the sugar.
- When making patties, sandwich the mixture between two pieces of wax paper (not plastic wrap); this way the patty will remain moist.
- Tearing a few holes in the wax paper on the underside of the patty will get the bees to start feeding.
- Dry extender can also be fed like pollen pellets.

Some pollen extenders available in bee supply houses may contain grain pest eggs or larvae; these can usually be killed by freezing the material for several days (at 0° F or -17.8° C); the material should then be placed in sealed containers to prevent subsequent contamination.

Notes

General Seasonal Management

INTRODUCTION

Timing is as critical to beekeeping as it is to most endeavors. To time one's beekeeping activities properly it is usually necessary to keep accurate records of past seasons and to carefully observe the flowering periods and the colonies' needs. Even then, there are capricious fluctuations from year to year or season to season that will make beekeeping a continual challenge.

This section is organized to take the beekeeper through the year—from early spring on into winter—so that one can anticipate the major tasks that must be attended to.

LATE WINTER, EARLY SPRING

Some of the tasks that should be attended to in late winter and early spring, before the fruit bloom, include the following:

- Look for signs of nosema or dysentery, especially yellowish to dark brown spots on the outside of the hive bodies.
- Try to determine the amount of food stores remaining; begin feeding, if necessary, as soon as the weather permits.
- If the weather is very cold, determine the amount of stores by lifting or tilting the hive; if the hive seems light, feed the colony.
- Check for dead colonies; remove or close up any dead hives to prevent them from being robbed; check to see if any dead colony succumbed to brood disease—if not, any honey remaining may be fed to other colonies that need it.
- Feed pollen supplement or extender in moist patties and honey in sealed combs or syrup to help stimulate brood rearing and provide medication for the bees (see *FEEDING BEES*).
- Unite weak colonies—those with less than five frames of bees—and kill the inferior queen.
- If the air temperature gets above 75°F (23.9°C), the colony may be checked for condition of the queen by examining the brood pattern—a compact pattern of worker brood indicates that a healthy queen is present; this examination should be brief, otherwise the brood can become chilled.
- If a colony is queenless, it should be united with another colony.
- Diseases or pest damage should be attended to.

A few related tasks should also be undertaken:

- Update the hive diary.
- Investigate clear water sources or provide fresh water.
- Clean the apiary of any winter debris.
- Prepare for the arrival of package bees.

LATE SPRING WORK

The following apiary tasks should also be incorporated into the spring management work during the dandelion/fruit bloom period and when all danger of frost is past:

- Unwrap and/or take down winter protection.
- Remove temporary winter windbreaks.
- Remove any insulating or moisture absorbing materials above the inner cover.

- When temperatures are around 75° to 80° F (23.9° to 26.7° C), inspect the hives for disease, brood pattern, and remaining stores.
- Replace poor queens (see *SPECIAL MANAGEMENT PROBLEMS: Requeening*).
- Reverse the upper and lower hive bodies of strong colonies to put the brood-nest at the bottom (see *SPECIAL MANAGEMENT PROBLEMS: Swarm Prevention Techniques; reversing*).
- Replace old, sagging, and drone combs; broken frames; etc.
- Clean bottom boards and scrape off excess propolis and burr comb.
- Check water sources or provide water.
- Provide additional space (hive bodies or supers) as needed.
- Make increases only when the weather is warm enough so the brood will not become chilled (see *SPECIAL MANAGEMENT PROBLEMS: Swarm Prevention Techniques; relieving congestion*).
- Medicate the colonies against brood diseases and/or nosema; do not give medication once the bees have begun to store honey or it will contaminate the honey.
- Look for signs of swarming and, if necessary, initiate swarm prevention/control techniques (see *SPECIAL MANAGEMENT PROBLEMS: Swarming*).
- Remove entrance reducers from strong colonies.
- Register hives and apiaries with state agricultural department.

Seasonal Fluctuations within a Hive

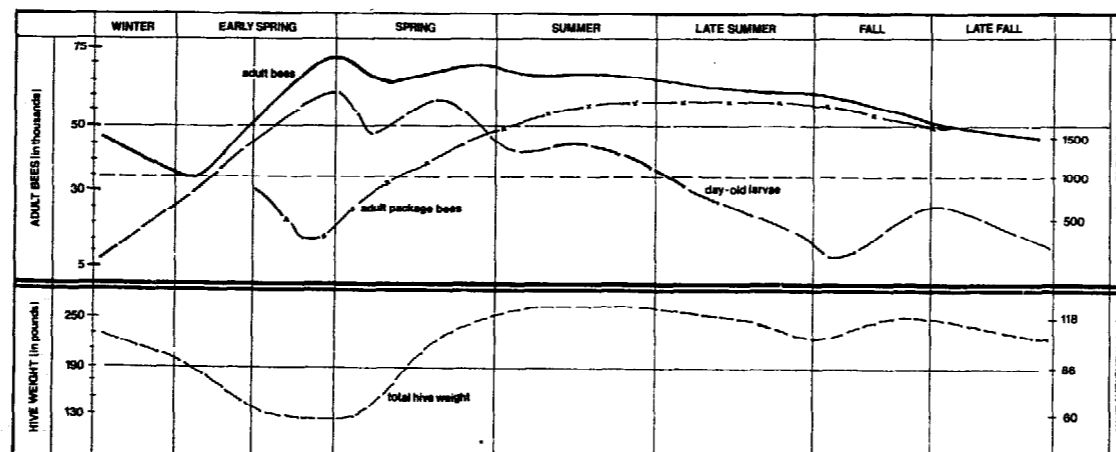

Adapted from charts by W. A. Stephen in Laurence J. Connor: "Beekeepers Calendar," *Ohio Bee Lines*, Cooperative Extension Service Bulletin #450. Columbus: Ohio State University, 1971.

Spring Dwindling

In some colonies, older bees may begin to die faster than young bees emerge and the number of bees is reduced to a point where the process cannot reverse itself: the colony dwindles to nothing. This is called *spring dwindling*—since it usually happens at that time of year. It may be prevented or checked by:

- wintering only strong colonies with ample stores of honey and pollen; combining weaker hives in the fall, if necessary
- providing high-quality winter stores
- having a young queen
- protecting the hive from winter and spring drafts and dampness
- a spring management program
- ample colony strength in spring; if there are only 3 or 4 frames of bees, unite it with a stronger colony
- good weather—if it is a rainy or cold spring, dwindling is more prevalent
- medicating the bees against nosema in the fall or spring (see *BEE ENEMIES AND DISEASES: Nosema*)
- prevention of brood diseases
- prevention of poisoning (from pesticides)
- prevention of drifting

SUMMER

Each colony should be examined closely about once a week before the major honeyflow begins in your area. Check the colony strength to determine whether it is populous enough; a colony

should reach a population of over 40,000 by the time of the major honeyflow.

Weak colonies should be united.

Here are two methods for estimating colony size:

- Try to count bees coming and going at the entrance; if they can be easily counted, the colony is weak; between 30 and 90 bees per minute indicates a strong colony.
- One deep frame covered with adult bees equals about one pound of bees (3,500 bees).

Other tasks during this time should include the following:

- Requeen where needed.
- Unite weak colonies with stronger ones.
- Check for diseases.
- Check the colony's food stores.
- Reverse the brood chambers again if necessary.
- Add honey supers as needed; when a super is 2/3 full (6 or 7 full frames) add another super (see *GENERAL SEASONAL MANAGEMENT: Rules for Supering*).
- Give frames of foundation in supers only if a good honeyflow is on, otherwise bees will chew the wax.
- Keep burr bomb and propolis scraped off frames and hive walls.

Cooling the Hives

When the temperatures are frequently above 90° F (32.2° C):

- Shade the hive from the noonday sun with fencing, boards, or shrubs,

or break some branches and place them over the hive cover.

- Stagger supers slightly to increase the air flow throughout the hive. Some beekeepers raise the inner cover or the front of the bottom super with small blocks; others bore a 3/4 inch (18.75 mm) auger hole in an upper corner of the top super.

—Make sure fresh water is available.

Prepare for the honeyflow by repairing frames or by preparing frames with foundation for the honey supers. Keep fresh wax foundation sheets in plastic bags to protect them against wax moth infestation and to keep them from drying, since dry foundation becomes brittle and breaks easily.

DURING THE HONEYFLOW

Signs

Honeyflows are periods during the year when bees are able to collect ample supplies of nectar. They may be of only a few days' duration or they may last a few weeks. Major honeyflows provide bees with more nectar than is needed to sustain the colony over short periods. This surplus is stored by the bees as honey in supers located above the brood chamber, and can later be taken off, or harvested, by the beekeeper.

A honeyflow is indicated by the following signs:

- hive scale shows weight gains over several days or weeks

- bees are easy to work
- fresh, white wax evident on ends of drawn comb and on top bars
- wax foundation drawn out quickly
- large amounts of nectar ripening in cells
- bees fanning at hive entrance
- lots of foraging activity
- odor of nectar (honey) often pervades apiary

During the honeyflow, the beekeeper should not break down the hive to look at the brood, nor should pollen traps be placed on hives. The colonies should be all checked *prior* to a major honeyflow. Entering the broodnest during a flow will disrupt the nest and the bees' gathering activities and may even reduce the amount of honey being brought in for several days.

Apiary Tasks

In general, the tasks at the apiary during the major honeyflow should include the following:

- Super hives as needed, placing honey supers above the broodnest (see *GENERAL SEASONAL MANAGEMENT: Rules for Supering*).
- Reverse honey supers.
- Provide adequate ventilation.
- Keep supers on until honey is capped.
- Avoid adding too many supers, as bees may partially fill all of them instead of filling one completely.
- Never* medicate colonies at this time as it will contaminate the honey. Honey collected by dis-

eased colonies that must be medicated must not be used for human consumption.

- Requeen poor, weak, or diseased colonies (see *SPECIAL MANAGEMENT PROBLEMS: Requeening*).

Super Sizes

When a honeyflow is on, the bees will deposit nectar in supers placed above the brood chamber. These supers may vary in size from full depth supers (deep hive bodies) to the shallow or section comb supers (see illus.). There is no hard and fast rule about which super size to use; personal preference, physical strength, and the quantity of the expected surplus should be your guide.

Rules for Supering

The most important rule for supering is to keep the queen out of the honey supers. Use one of the following methods to accomplish this:

- Place a queen excluder above the broodnest.
- Keep a hive body filled with honey directly above the broodnest.

Some general guidelines for supering bees during a honeyflow are listed below:

- Stagger the honey supers to hasten the ripening of honey.
- Use only 8 or 9 frames in the supers for honey that is to be extracted so the bees will draw cells out more, making it easier to cut the cappings.

- Bait an empty honey super with a frame or two of capped or uncapped honey; this should make the bees move into this super.
- It becomes increasingly difficult to cut away the cappings of combs that have been darkened with propolis. These frames should be used only for brood rearing (if full depth) or should be rendered into wax.
- Some beekeepers use drone foundation in their honey supers since the cells are larger and honey seems to extract readily from these cells.

Methods of Supering

There are two basic ways to super for honey; they are called *reverse* supering and *top* supering.

Reverse Supering. This method can also be used for comb honey and generally needs a queen excluder to keep the queen from laying in the honey supers (see illus.). A super with foundation or dry combs (S-1) is always placed *below* a super at least half full of honey (S-2).

Top Supering. This method does not require a queen excluder since the queen rarely will go above a super full of honey. Put supers with dry comb or foundation (S-1) *above* honey supers that are at least half filled with honey (S-2).

There are many methods of supering using these two themes; talking with local beekeepers may be helpful in determining how to super in your particular area.

Reverse Supering

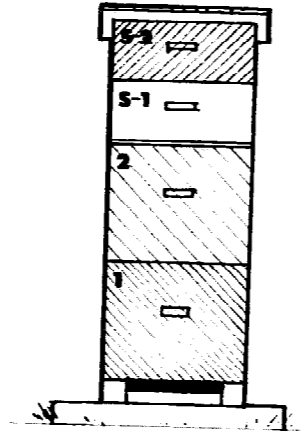

Top Supering

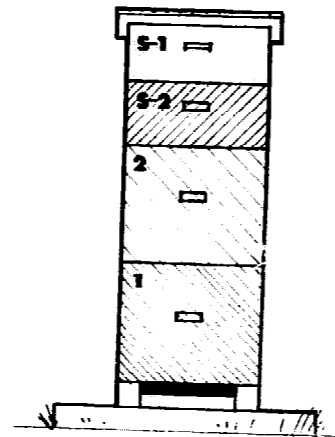

Sizes of Supers

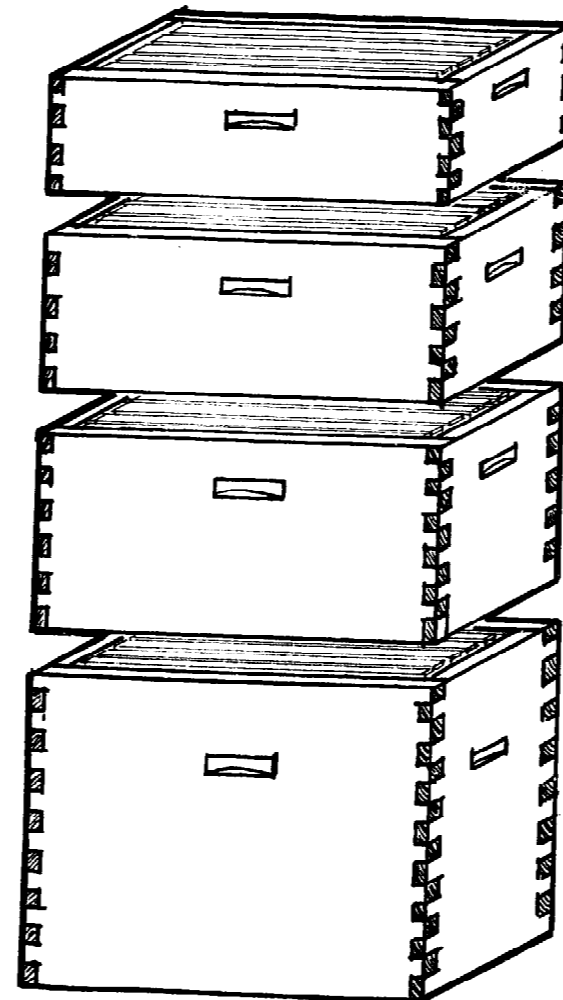

shallow
4 5/8" (12.2 cm)
full weight 25 lbs (11.3 kg)

half depth
5 11/16" (14.4 cm)
full weight 35 lbs (15.8 kg)

three-quarters depth
6 5/8" (16.8 cm)
full weight 65 lbs (29.3 kg)

full depth
9 5/8" (24.5 cm)
full weight 90 lbs (40.5 kg)

 BROODNEST

 HONEY

 DRY COMB

 QUEEN EXCLUDER (QE)

Chart I—Reverse Supering Sequence

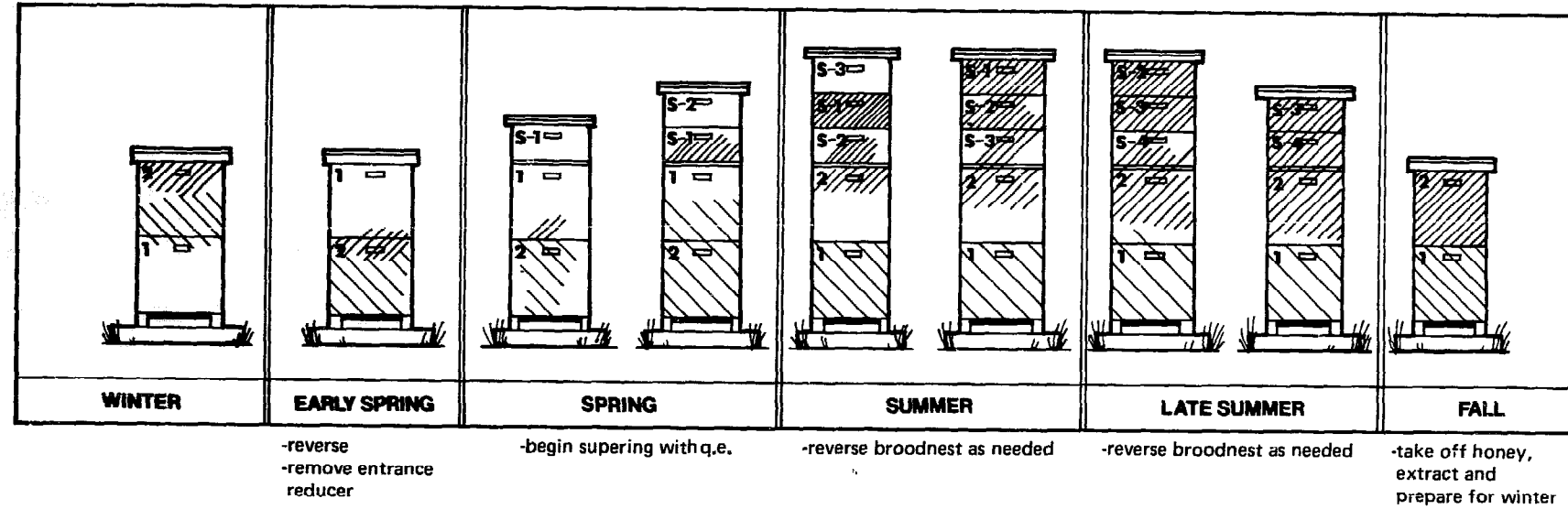

Chart 2—Top Supering Sequence

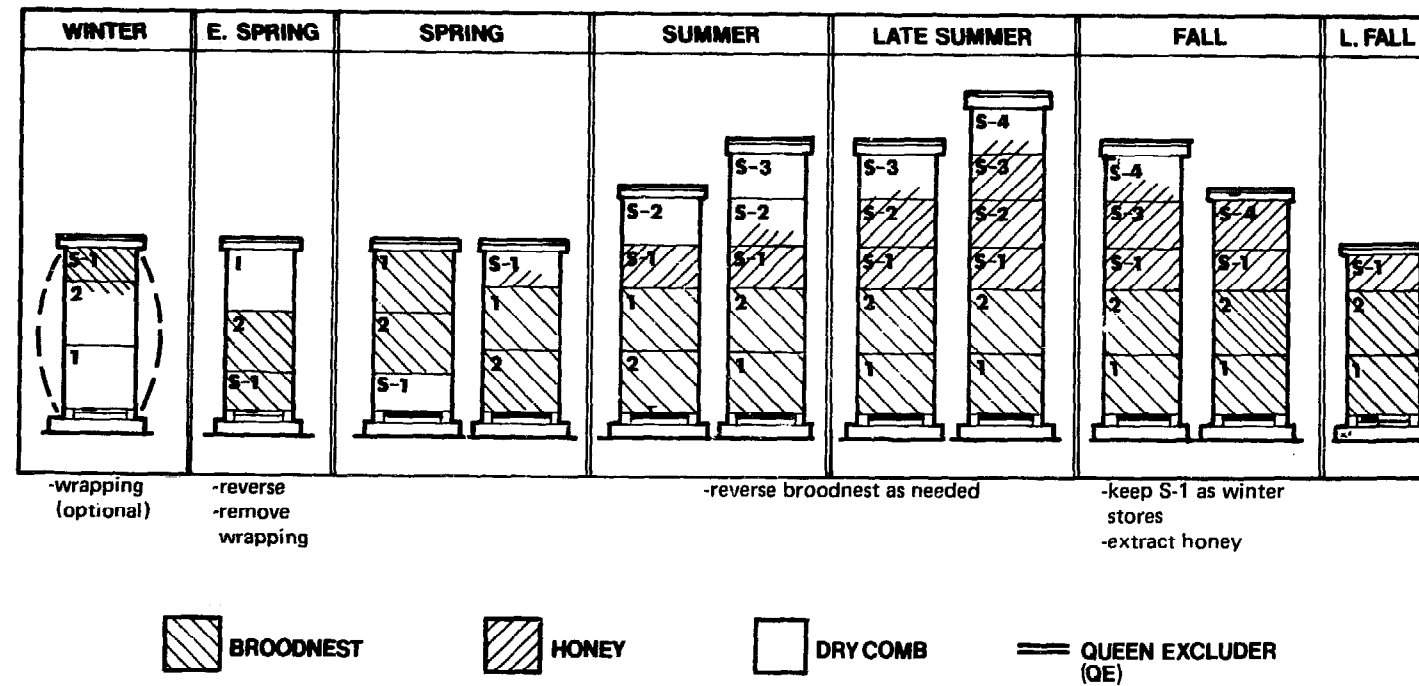
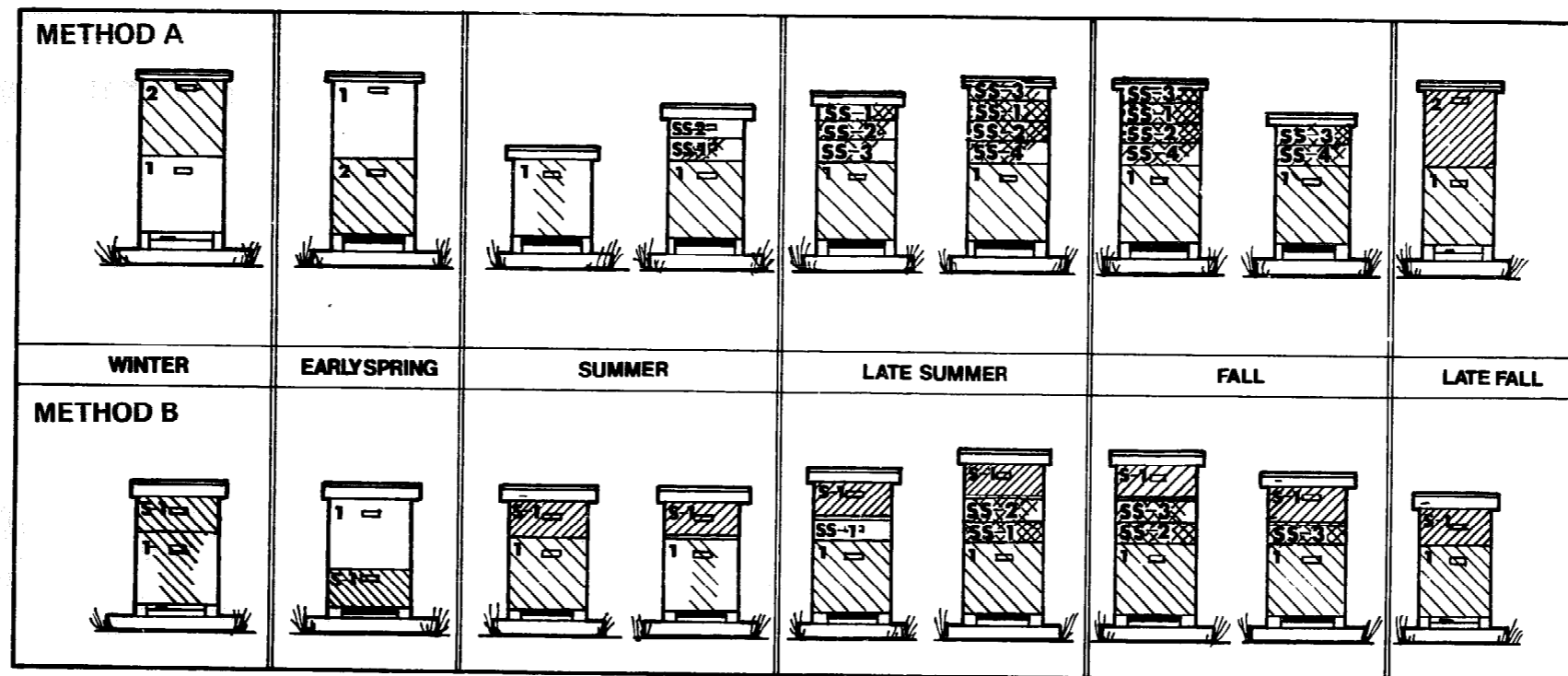

Chart 3 - Supering for Section Comb Honey



-split hive, shake bees, put on q.e.

-all ss go below q.e.

-remove q.e. and ss.

 BROODNEST

 HONEY

 SECTION SUPER (SS)

 DRY COMB

 QUEEN EXCLUDER (QE)

Bulk, Chunk, Section, and Cut Comb Honey

Some beekeepers, instead of extracting the honey from the comb, cut the honey-filled comb from the frames and bottle it with extracted honey or place the cut, honey-filled comb in plastic wrap or containers. Section comb honey, in small wooden frames, is usually placed in cardboard containers; Cobana comb honey, in round plastic frames, is covered with two plastic lids, requiring no other special packaging.

Foundation for the chunk, bulk, section, or cut comb honey should be the thin, unwired type. As soon as the combs are sealed, they should be removed from the hive to prevent the white cappings from becoming darkened with propolis or soiled by travel stains.

The supers containing frames for chunk, bulk, section, or cut comb honey production should be placed on a strong colony that consists either of two brood chambers or of a colony reduced to one brood chamber (as described for the production of section comb honey). Place an excluder above the broodnest and super the hive using the same rotation illustrated for section comb honey.

Supering for Section Comb Honey

Comb honey, especially section comb honey, is difficult to produce because success depends on a relatively heavy honeyflow, strong colonies, and time-consuming hive manipulations at the correct intervals. The Miller method of

supering is one which is used for section comb honey; this is described below and is illustrated in Chart 1, Method A.

—A colony used for section comb honey production is generally wintered in two deep hive bodies (#1 and #2); in the spring, this colony must be built up to full strength prior to the major honeyflow, and the brood chambers should be reversed to provide ample room for the queen to lay.

—As soon as the honeyflow begins, reduce the strong two-story colony to one deep (#1), and set up this colony so it contains two empty brood frames (in the middle) and as many frames of capped brood as possible on either side, with accompanying queen and bees.

—Shake bees off all remaining frames from deep #2 at the entrance of #1; frames of honey and any remaining brood frames from #2 should be given to other colonies.

—Over the reduced hive (#1), place the first section super (SS-1), with thin foundation in the section boxes or cobana frames.

—When SS-1 is half full of honey, place a second section super (SS-2) above it.

—When SS-1 is almost filled, reverse it with SS-2 (so the full super is above the empty one).

—If the honeyflow is strong, add a third (or subsequent supers, SS-3, etc.) above the first (SS-1) until SS-2 is half filled, then reverse

again so the full supers are above the empty one.

—Remove the completely filled section supers after using bee escapes to ensure all the bees are out of the supers; *never* use a fume board since the honey might be adversely flavored.

Comb honey should be marketed as soon as possible to reduce the danger of it granulating or being damaged by wax moths. The freezer is a good place to store comb honey. After the honeyflow is over and the section comb honey production ceases, unite the reduced colony with another hive or otherwise allow it to build up enough stores to overwinter in two deep hive bodies.

For another way to super for section comb honey see Chart 3, Method B.

HARVESTING THE HONEY

In some regions, two crops of surplus honey can be expected, one in the summer and another in the fall. Some beekeepers harvest the summer and fall crops separately; others harvest both at the end of the fall honeyflow.

Average yields of honey depend on the amount of open land filled with honey plants. Yields vary from 25 pounds of surplus per colony up to 90 pounds or more. For hives located in temperate climates, about 60 pounds of honey should be left on for overwintering each colony (see *GENERAL SEASONAL MANAGEMENT: Wintering Hives*).

Removing Bees from Honey Supers

The methods listed below describe five ways of removing bees from honey supers. Honey supers will also be free of bees when it gets very cold (in the early fall) after the bees leave the honey supers to join the warm cluster below.

Shaking. Remove a frame with sealed honey from the super and shake the bees off in front of the hive entrance, then gently brush off the remaining bees.

Brushing. Use a soft, flexible bee brush (see illus.), or a handful of grass and gently brush the bees off the frames, allowing them to fall at the hive entrance. Then place the frames, free of bees, into an empty super and cover it with burlap or a thick, wet cotton sack to keep out robbers. If robbing is particularly intense, an additional cloth might be needed to cover the super you are working. If robbing becomes unmanageable, put the honey frames into a vehicle and close all doors and windows.

Advantages:

- able to select frames containing capped honey (honey covered by thin layer of wax)

The Bee Brush



- relatively easy if bees remain calm
- inexpensive for one who has few hives

Disadvantages:

- may promote robbing
- time consuming
- brushing may excite bees to sting

Bee Escape. The Porter bee escape is an inexpensive metal gadget which allows bees to pass through it in only one direction. The escape fits into the oblong hole of the inner cover, or any cover that has been modified to hold 4 or 5 bee escapes in order to facilitate the passage of bees. When an inner cover or modified cover contains one or more bee escapes, it is referred to as an *escape board*.

The escape board is placed directly below the honey supers the beekeeper wishes to remove (see illus.). Usually within 48 hours after the escape board is in place, the bees will move down to seek the warmth of the broodnest or the bee cluster and, since many of these bees are field bees, they may want to leave the honey supers to resume foraging activities.

In extremely warm weather, place the escape board on during the later afternoon and remove the supers before noon the next day. This will prevent the wax comb from melting since the bees can no longer fan it.

If the supers contain brood, the bees will be less likely to abandon them. All the brood should be allowed to emerge. To do this, place these supers above a queen excluder so the queen cannot get up there and lay; all the brood should be

out within 25 days.

There must be *no* cracks or holes in supers placed above an escape board since bees from the same hive and/or robbing bees and other insects will invade and remove the honey. Tape or otherwise close off these entrances to the unprotected honey supers. If the outer cover is warped and you are using the inner cover as an escape board, put an extra inner cover above the topmost super to close off the top and to keep all bees out.

Advantages:

- does not excite bees
- easy
- inexpensive
- usually effective

Disadvantages:

- honey could be removed by bees from the same hive or by robbers if supers are not bee-tight
- not always effective
- drones or dead bees may block escape, keeping bees in supers to be vacated
- involves extra trips to apiary to insert board, remove supers, and so forth

Repellent board. Repellent boards are used by some beekeepers to drive bees out of the honey supers. An absorbent pad or cloth is placed inside a spare outer cover or other holder. The pad is then saturated with a chemical which repels bees. Some fume boards have a black metal top which will absorb heat and make the chemicals work better. These boards work best when the bees are in shallow supers.

To use a fume board:

- Saturate a pad with the repellent chemical.
- Remove the outer and inner covers, using smoke as needed.
- Scrape any burr comb off the top bars.
- Use smoke to drive the bees downward between the frames.
- Place the saturated repellent board over the frames (see illus.).
- After no more than five minutes, the bees will have left the super.
- Remove the first super and repeat the process for subsequent supers below.
- Air the supers thoroughly and store them in a covered place to prevent robbing.

Use the repellent board only long enough to get the bees out of the supers. *Do not leave it on the hive for more than a few minutes.*

Some chemicals used as repellents are:

- glacial acetic acid
- propionic anhydride
- butyric anhydride
- benzaldehyde

Federal and state laws may restrict the use of some or all of these chemicals as bee repellents, so comply with all regulations in this regard.

The use of these chemicals is further complicated by the fact that their efficiency is governed by the air temperature;

Removing Honey Supers

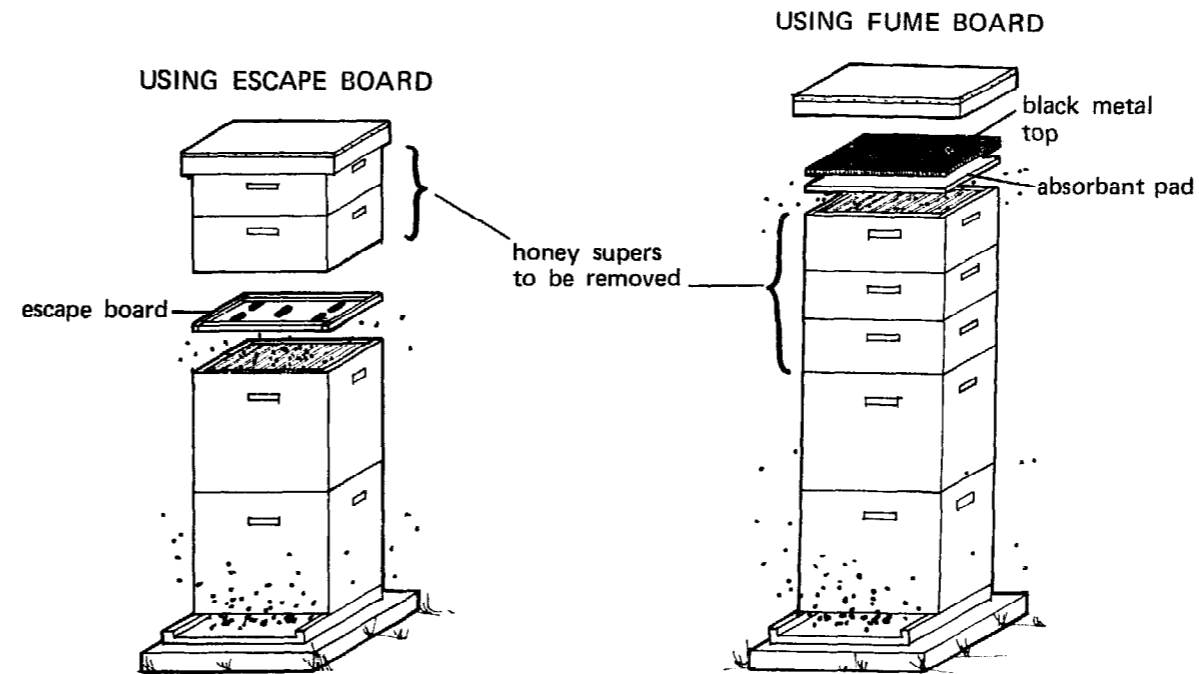

therefore, the desired result is not always certain.

Advantages:

- one trip to remove honey
- easy
- inexpensive

Disadvantages:

- excites bees
- dependent on temperature
- could adversely flavor honey
- may be illegal to use

The Bee Blower. A bee blower is a portable gas or electrically powered device that produces a blast of air strong enough to blow the bees off the frames and from the supers.

Advantages:

- fast
- effective

Disadvantages:

- expensive
- during cold weather, bees blown out may be unable to return to hive
- requires two people—one to load supers—to work efficiently

Getting Along with Your Back

Lifting off supers full of honey might be the reward of a productive year, but it can also be a literal pain in the back. Unless you are careful in lifting these heavy boxes, serious damage could be done to your back. Proper lifting and strengthening exercises might be needed if chronic backpain is a problem. In any case, medical advice should be sought. For some general information on back care see *REFERENCES: Honey.*

EXTRACTING THE HONEY

The usual process for getting honey out of the wax cells is to remove the capings with a hot knife (uncapping knife) and put the uncapped frames into a huge centrifuge, called an *extractor*. As the extractor spins, the honey is forced out of the cells and against the cylindrical wall of the extractor, leaving the frames of wax combs empty of most of the honey. A small gate at the bottom of the extractor can be opened to let the honey flow out into other containers.

Honey that is kept in supers prior to extraction can be ruined if it is stored in a humid or wet area since even capped honey can absorb water vapor. To prevent this, stack the supers in a staggered arrangement to allow ventilation and either use a dehumidifier or blow warm, dry air over the combs before extracting. This will further reduce or maintain the existing low moisture content of the honey.

Frames to be extracted should be completely or almost completely capped. Uncapped cells will contain honey with a higher moisture content; extracting too many partially capped frames will increase the moisture of the extracted honey and invite spoilage by fermenting yeasts (see *PRODUCTS OF THE HIVE: Honey; extracting*).

FALL

After the fall crop has been removed and the supers have been cleaned and

stored, each colony should be checked and attended to as follows:

- If possible, pick a day when there may still be a light honeyflow and forager bees are out, since in the fall bees are more prone to sting when a hive is being manipulated.
- Check for brood diseases.
- Do not attempt to overwinter a colony found to have American foulbrood; destroy the colony.
- Medicate for nosema and American and European foulbrood as a preventive measure (see *BEE PESTS AND DISEASES*).
- Remove queen excluder.
- If requeening, check after 7 days to see if the queen has been accepted.
- Check winter stores (60 to 80 lbs., 132 to 176 kg, of surplus honey should be left for each colony).
- Feed the colonies whose stores are low.
- Replace damaged equipment.
- Reduce bottom entrance or cover with hardware cloth; provide a top entrance.
- Unite weak colonies.
- Remove and store empty hives.

WINTERING

General Rules

Colonies can survive very well without elaborate wintering techniques as long as the bees are protected from winter winds. However, following the minimum

procedures for wintering hives can be the difference that makes for overwintering success. These are the most common wintering practices:

- Invert the inner cover (to rim-side down) to allow moisture to escape.
- Reduce the entrance with a wooden cleat. Make sure that the opening of the cleat is turned up against the hive body, not against the bottom board; this will prevent the opening from becoming blocked by a layer of dead bees which may accumulate on the bottom board during the winter.
- Provide top ventilation and/or entrance by propping up the inner cover slightly or boring an auger hole, not more than 1 inch (2.5 cm) in diameter, in an upper corner or below the handhold of the top super; this lets moist air out of the hive.
- Unite weak hives.
- Place weights on top of hives so the covers will not blow off in high winds.
- Remove queen excluders.
- Remove bee escapes.
- Leave ample honey (or cured sugar syrup) and pollen stores.

The Winter Cluster

Honey bees do not "hibernate" in the winter but cluster in a ball when the air temperatures are below 57°F (13.9°C). They remain relatively active in the cluster because of the heat generated by the contraction of their wing muscles.

The Winter Cluster

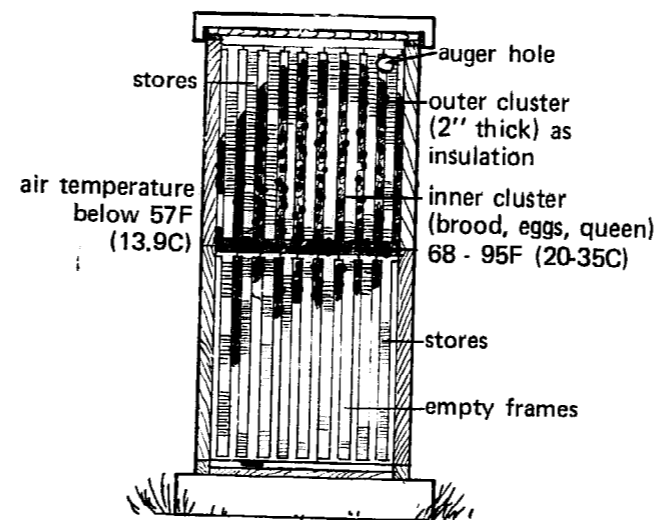

Adapted from C. L. Farrar: "Production Management of Honeybee Colonies in the Northern United States," USDA circular #702, July 1944.

The amount of heat generated by the cluster depends, among other things, on whether or not brood is present. In the late fall, the colony is without brood and, therefore, the cluster will be producing only around 57°-60°F temperatures (13.9°-15.6°C)—enough to keep the colony from freezing. When the queen resumes her egg laying in midwinter, the cluster temperature in the vicinity of the eggs and brood will be maintained at around 93°F (33.9°C) (see illus.).

Connective clusters of bees join the main cluster to the food stores. If these connectives are cut off, or if the winter is unusually long and very cold, the bees could starve even though there is honey elsewhere in the hive. The cluster must be able to move to the food periodically throughout the winter. In general, the cluster will move into the upper stories during the cold weather, and if the honey is not placed or stored above the cluster in the fall the bees may move up into the empty supers and starve.

Bees retain their feces when confined to the hive as they commonly are during the winter. Periodically, air temperatures reach 57°F (13.9°C) or above, and on such days bees are able to break their confinement to take cleansing flights and defecate outside the hive. If the bees are confined to the hive over long periods, the hive floor and frames can become littered with fecal material and dysentery can weaken the bees further.

High winter survival depends on:

- cold winters interspersed with warm sunny days

- dry winters
 - long springs
- Low winter survival is due to:
- wet, cool winters
 - long, cold winters with few sunny, warm days (reducing or eliminating opportunities for cleansing flights)
 - nosema disease

In Warm Climates

If winter temperatures do not get much below 45° to 68°F (10° to 20°C), it is not necessary to provide the same winter protection, such as wrapping and insulation, that is required in colder regions. However, to ensure a strong colony when the nectar flows again, a colony should have the following:

- a young, vigorous queen
- adequate food stores (about 30 pounds of honey)
- protection from extreme temperatures (reduced bottom entrance, an upper entrance, shelter from cold winds)
- periodic inspections

In Cold Climates or High Altitudes

In regions where average temperatures during the coldest months are around 20°F (-6.7°C), one should leave about 70 pounds of honey on each colony or feed an amount of sugar syrup that will equal 70 pounds of honey. If sugar syrup is to be fed to bring the food stores up to 70 pounds, it must be given to them while the weather is still

warm so it can be properly cured; the syrup should be 2:1, sugar:water (see *FEEDING BEES*).

The following are essential for a colony to overwinter successfully, emerge in the spring with sufficient numbers, and be capable of taking full advantage of spring and early summer nectar flows:

- a young, vigorous queen (prodigious egg layer)
- large population of bees (20,000 to 30,000)
- adequate supply of honey, cured sugar syrup, and pollen
- disease-free condition (medicate)
- an upper entrance (auger hole in top super)
- top ventilation to release moist air (prop up inner cover)
- protection from prevailing winds
- reduced front entrance
- periodic inspections
- maximum sunlight

Specific wintering techniques such as wrapping, insulating, and the like are discussed in the rest of this section.

Windbreaks

Apiaries should be located where they will be sheltered from prevailing winds to reduce the amount of cold drafts in winter and spring. Hives should be situated where barriers such as evergreen, thick deciduous growth, walls, or buildings will take the brunt of the prevailing winds. When no windbreaks are present temporary ones should be constructed to lessen the velocity of the

wind as it approaches the hives, but they should still permit air drainage to take place.

A suitable windbreak would be a 6-foot high snow fence, or slotted board fence, set up on one or all sides of the apiary; the boards should be about 1 inch apart to allow air to filter through but block the wind flow. The first row of hives should be about 5 feet (1.5 m) from the windbreak.

Wrapping

Hives can be wrapped with a light tar paper or blackjack to protect the bees from chilling winds; the dark color will also absorb the sun's heat. There are several procedures for wrapping hives, and most of them incorporate these features:

- top ventilation
- top and bottom entrances
- absorbant material enclosed in a super over an inner cover to draw off moisture (straw, shavings, porous pads, corrugated paper, fiberglass, insulite board, or other building insulation)
- dead air space underneath hive
- use of mouse poison, like treated grain, on the bottom board and/or the inner cover, or other mouse protection

Advantages:

- protects from piercing winds
- allows hive to warm up when sun is out
- bees can recluster on honey if inside temperature is warm enough

Disadvantages:

- time consuming
- vapor barrier may form between hive and tar paper resulting in excess moisture accumulation in the hive which, if it freezes, will encase bees in an "ice-box"
- hive may warm up too much and bees may begin premature cleansing flights outside before air temperatures are high enough to protect them from being chilled

Insulation

Insulation will provide colonies with extra protection against cold winter temperatures. Any one or a combination of these insulating materials and devices have been found to be of some aid (see illus.):

- Provide dead air space underneath the hive.
- Place *follower boards* against the inside walls. A follower board is a solid piece of board the size of a deep frame, of variable thickness, that hangs like a frame; it can be used to reduce the interior size of a deep super by substituting it for one or more frames.
- Insert a division-board feeder (can substitute for follower board).
- Insulate the top with moisture-absorbing material (one or a combination of the materials listed below) placed between the outer cover and the inner cover (rim-

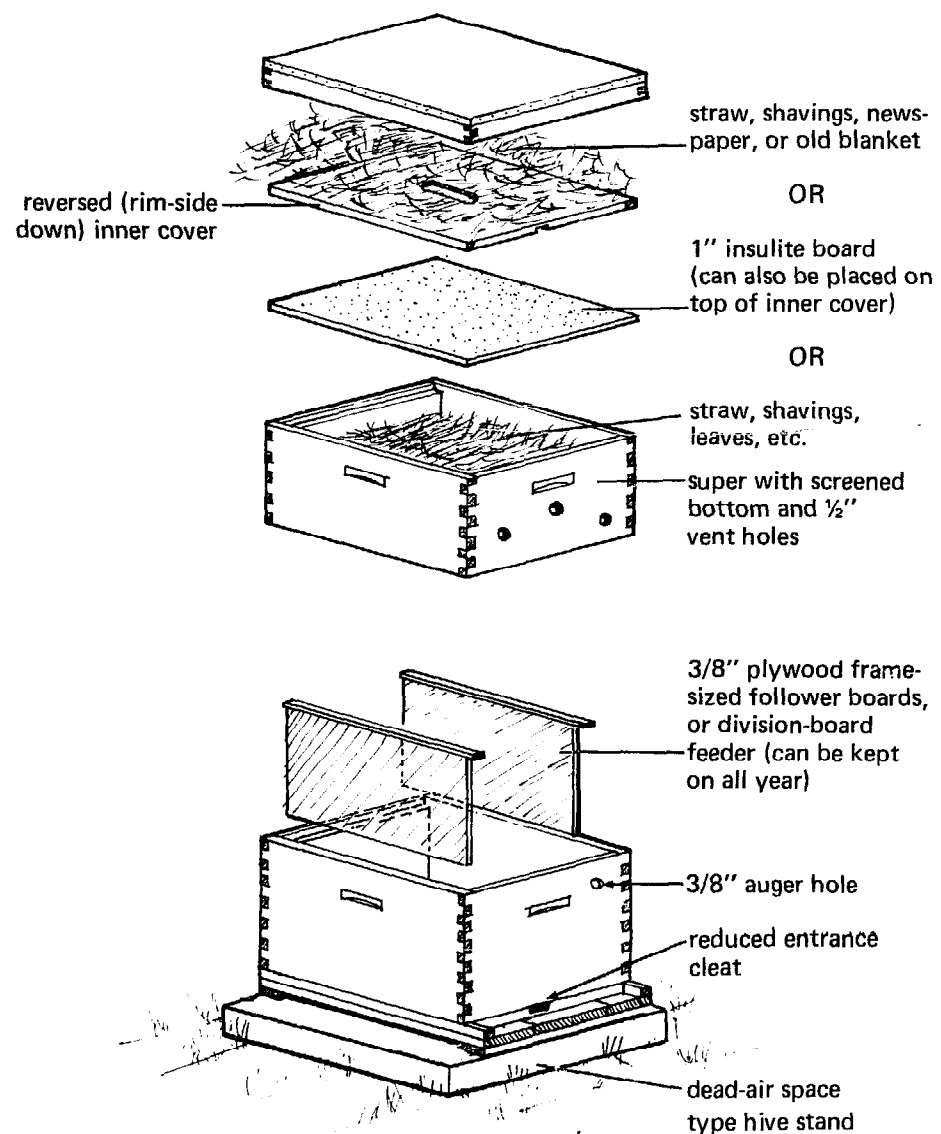
Wintering Bees (different kinds of insulation)

side down); make sure the oblong hole is open:

- 1-inch insulite board
- newspaper, straw, leaves, old blankets, etc.
- an empty hive body with screened or burlapped bottom on top of inner cover and filled with leaves, shavings, or straw

Some beekeepers put a super of dry, drawn comb on top of the inner cover, although these combs can collect excess moisture and be damaged.

Hives can also be double-walled (or a "cover" can be slipped over a single-walled hive) and the spaces between the walls can be filled with insulating material.

Miscellaneous

Cellar wintering, once extensively practiced in the northeastern states, is no longer practical. This type of wintering requires that only the strongest hives be placed in a draft-free location where temperatures are kept between 40° and 50° F (4° to 10°C); temperature control is very important. Today, it would be very costly to construct such a structure.

Hive heaters are thermostatically controlled devices which maintain a constant temperature in the hive. These devices are expensive and require an electrical outlet in the vicinity of the apiary. Otherwise, the hives must be moved near an outlet in the fall; this is an extra energy user and would be expensive if one has many hives.

PREPARING FOR THE NEXT SEASON

The following tasks should be attended to during the winter months in preparation for the next spring season:

- Clean supers and frames of burr comb and propolis.
- Paint and repair equipment; replace with new equipment when necessary.
- Sort and cut out old, sagging, diseased, damaged, or drone combs and replace with foundation.
- Store wax foundation and scrapings in moth-proof containers.
- Build new equipment.
- Order new equipment and bees for spring arrival.
- Check apiary periodically for damage by wind, vandalism, skunks, etc.
- Melt wax scrapings.

See *REFERENCES: Management of Bee Colonies and Beekeeping Pamphlets.*

Notes

Special Management Problems

UNITING COLONIES

Newspaper Method

Although two weak colonies do not usually make one strong one, a weaker colony can be united to a stronger one. If you have a preference for one of the queens, eliminate the less desirable one; if not, proceed and one of the two queens will survive.

The best use one can make of the bees in a weak colony is to unite them with a strong one just before the honeyflow—the united bees will be able to gather more honey. Or, if it is determined early in the spring or summer that a colony is weak, its position in the row or apiary can be interchanged with a strong one to increase its population (see *SPECIAL MANAGEMENT PROBLEMS: Swarm Control Techniques; interchanging hives*). It can then be strengthened further by adding frames of capped brood (without any adult bees) from one or several strong colonies. If, after these manipulations the existing queen fails to improve, the colony should be requeened or united.

To strengthen a weak hive, either unite a swarm to it or unite it to a stronger colony. It must be remembered that when two different colonies are united, the hive of each has its own set of odors, and unless some precautions are taken the bees will fight. The most successful and least time consuming method of uniting colonies is the newspaper method:

- Put a single sheet of newspaper over the top bars of the stronger colony (see illus.).
- If the weather is warm, make a few pencil-sized holes or small slits in the paper with a stick or hive tool.
- Set the weak hive on top and cover; field bees from the weak colony's original hive site will probably drift to other hives.
- The paper will be eaten through slowly by bees and most of the paper will be chewed up in a week; shredded paper will appear at or near the hive entrance.
- If the weather is extremely hot, unite the two hives during the late afternoon.
- If there is a dearth of nectar and pollen and the bees are unusually aggressive, decrease the possibility of fighting by feeding the stronger hive for a few days before uniting.

Uniting Colonies — Newspaper Method

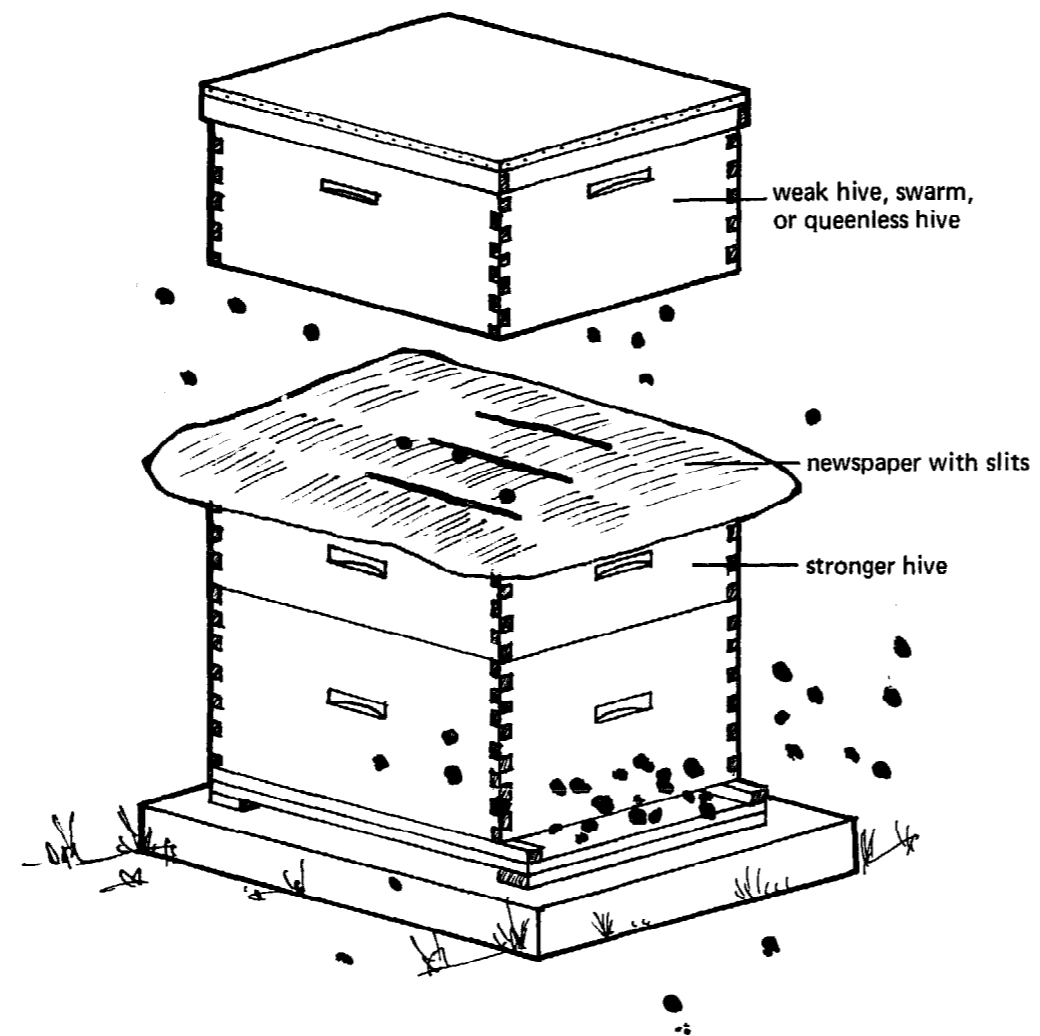

MOVING AN ESTABLISHED HIVE

Preparing the Hive

Follow the procedures described below to safely move an established hive. It is a general practice to move a hive at least 3 miles (4.8 km) from its old site; if it is moved a distance of less than 3 miles, many field bees will return to the old location and become lost. The best time to move hives is in the spring, when populations are the lowest and the hives are light in weight.

- You must first check and comply with all legal requirements pertaining to moving and/or selling bees. Have the state inspector certify that the bees are disease-free.
- If the hive consists of more than two hive bodies, supers that are relatively free of bees should be removed first to make the moving operation less cumbersome. To remove bees use a bee blower or shake or brush the bees from the frames onto the grass in front of the hive. Or place an inner cover fitted with a bee escape above the second deep body (see *GENERAL SEASONAL MANAGEMENT: Harvesting Honey; removing bees from honey supers*); after two days, the upper hive bodies should be vacated unless they contained brood.
- In the spring, the bees will usually be in the upper hive bodies; after

- removing the empty lower hive bodies, place the hive bodies containing bees (usually two deeps) directly on the bottom board.
- Tape or screen all holes and cracks in the two remaining deep hive bodies.
 - If the weather is warm, place a screened board (like a division screen) or screened inner cover on top of the hive beneath the outer cover.
 - Using smoke as needed, hammer in hive staples on all sides (slant staples in opposite directions, alternating on each side; see illus.); steel or plastic strapping lath might also be used. Do not use electrician's staples as they could split the wood.
 - If the hive is very populous or if the weather is very hot, add a shallow super with empty frames above the top hive body to collect the overflow of bees; otherwise, the bees might be hanging outside the hive when you return to move them.

Loading and Unloading

- In the evening, smoke the entrance to drive the bees in and use a piece of screen the length of the entrance and about 5 inches wide to close off the entrance (see illus.). Slide the screen into the entrance so it will spring against the bottom board and hive body.
- If the weather is hot, remove the

outer cover while transporting so the screened top is exposed.

- The hives should be placed close together on the truck with the frames parallel to the road; this will prevent the frames from sliding together if the truck stops suddenly.
- While loading and unloading, keep the engine running since the vibration of the vehicle will help keep the bees in their hives.
- Smoke the entrances before and after unloading, then remove the entrance screen.
- Fill the hive entrance loosely with grass to slow the bees' exit and to keep them from drifting.
- Replace the outer cover.
- Inspect the hive after a few days to see if all is well.

Problems in moving hives:

- bees can suffocate if weather is too hot
- queen could be killed, injured, or balled
- hive bodies might break
- combs could break
- if moving in winter or very early spring, the winter cluster could be broken resulting in bees recluster-ing on empty combs and starving, or in the existing brood being chilled before the bees have a chance to resettle

Moving Short Distances

Follow these procedures to move an established hive less than 3 miles (4.8 km):

Moving an Established Hive

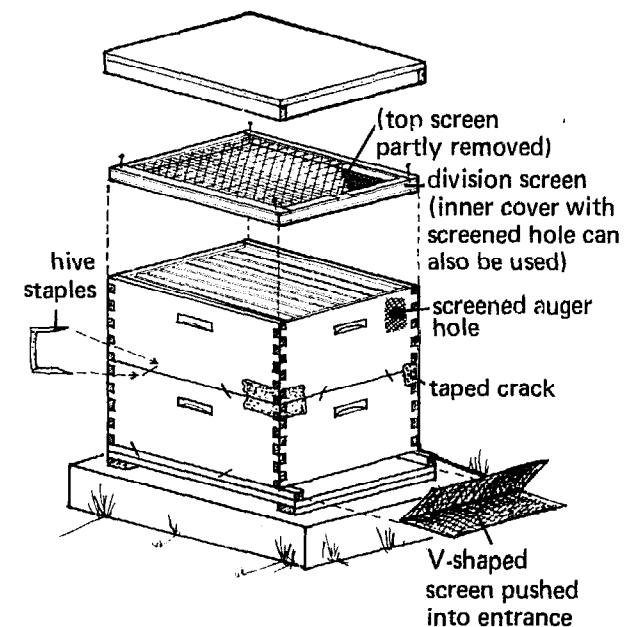

- Move the hive off its stand to the new location.
- In its old location, put a nuc box (small hive with four or five frames) or one deep hive body with bottom board and top cover.
- Fill the hive at the old location

with dry comb frames and at least two frames of brood, with or without a queen or queen cells; if you wish, make a split (see *SPECIAL MANAGEMENT PROBLEMS: Swarm Control Techniques; relieving congestion*).

—Field bees of the original hive will return to the new hive at the old location; this hive with the low bee population can be left and then moved at one's convenience.

Or:

—After two or more days, if the weather has been good, move the small hive from its original location to a new site at least three miles away.

—After three weeks, this hive may be moved to a desired location or it may be united to original colony (see *SPECIAL MANAGEMENT PROBLEMS: Uniting Colonies; newspaper method*).

Or:

—Move all the hives to be relocated over three miles away for three weeks and then move them again to the desired location.

—It is often recommended that when moving established hives very short distances, each hive be moved 1 foot each day (0.3m/day) until the hive is in the desired location (the bees will not return to the original location). However, this process is slow and not recommended unless the distance is less than 30 feet (9 m).

MARKING OR CLIPPING THE QUEEN

Some beekeepers choose to mark the queen with a spot of color or a color disc (with or without numbers) on her thorax, or they clip her fore and hind wings on one side. Marking or clipping the queen allows the beekeeper to keep a record of the ages of his queens and the use of color will also make it easier to find her, especially if she is dark. Clipping the wings of a queen will not control swarming, although this erroneous fact is stated in the literature.

Never hold the queen by the abdomen when picking her up to mark or clip her. If the queen is picked up this way, she can become injured and her egg-laying ability will be reduced; as a result of this or any injury to the queen, the colony may supersede (replace) her.

To avoid the possibility of injuring a queen, first practice on a few drones. To mark the queen:

—Grasp the queen by the wings, then transfer the hold to the sides of her thorax.

—If marking with a color spot, use a fast-drying paint like nail polish; mark *only* the thorax.

—If marking with a disc, apply adhesive on thorax, then the disc.

—Allow paint or adhesive to dry before returning queen gently to frame on which she was found, or place her on the top bar of a frame and let her walk down the comb.

If clipping the queen's wings, pick her up as described above and use manicure scissors to cut half of both the fore and hind wing on one side only (see illus.).

The queen can be removed from the hive without alarming the other bees; in fact, for short periods (5-10 minutes) they will not be aware she is absent.



Some beekeepers requeen every other year to maintain quality stock. To keep track of the queen's age, they clip her on the right side on even years and on the left side on odd years. The same system can be used with two colors. In Europe, beekeepers use a color system on a five-year sequence: Blue, gray, orange, red, and green, starting again with blue on the sixth year (the color for 1977 is orange).

Advantages of marking the queen:

- queen is easily found
- queen's age can be determined and recorded
- queen's absence will be indicative of some colony change

Advantages of clipping the queen:

- queen's age easily determined
- absence of clipped queen will indicate colony change

Disadvantages of marking and clipping:

- bees might supersede "maimed" queen
- clipping does not prevent or control swarming
- queen could be injured
- queen clipped may be a virgin and thus would be unable to fly and mate
- virgin queen might sting when handled (but this is not likely)

Failure to Find a Marked Queen

If the beekeeper fails to find a marked queen, it can be assumed that either part of the colony may have swarmed with her, she was superseded (replaced), or she was accidentally lost and subsequently replaced. If the queen is not found but eggs and brood are present, one should assume a queen is in the hive. If no queen is found and/or no eggs or brood are present, look for queen cells about to hatch or assume a new young queen is present but has not yet begun to lay.

A virgin queen might be difficult to locate because she tends to move more quickly on the comb than a laying queen. She might also be a little smaller than a laying queen (more the size of a worker) since she loses some body weight before the mating flight and needs time to regain it before she starts to lay. The absence of eggs or brood in a colony, therefore, could mean that a virgin queen has not yet mated or has not begun to lay eggs. Before requeening such a hive, be sure that the colony is queenless since any attempt to introduce a new queen into a hive with a virgin queen or newly mated queen present is likely to fail.

On the other hand, laying workers are present if one finds scattered brood, scattered capped drone cells, and/or several eggs in each cell that are attached to the cell walls instead of the bottom (see *SPECIAL MANAGEMENT PROBLEMS: Laying Workers*).

Notes

SWARMING

By reproducing, organisms perpetuate and protect their kind from extinction. Social insects like the honey bees can reproduce new individuals within the colony unit, but this is not sufficient for their continued survival. If bees were to maintain themselves solely by producing young, their colonies—without man's intervention—would diminish as a result of disease, fire, predators, and adverse environmental conditions.

Honey bee colonies perpetuate themselves by swarming. Swarming is a natural process whereby a colony divides so that part of it leaves for a new homesite, usually with the old queen, while the remaining members continue at the original site with a newly emerged, and later mated, queen. In this manner, a single unit becomes two.

An abundance of queen cells, often called swarm cells, indicates that swarming preparations are underway. Shortly after the swarm cells are sealed, the colony will cast a swarm. Bees will exit as a swarm on any warm, windless day, usually between 9 a.m. and 3 p.m. (earlier or later if the weather is favorable). Occasionally, bees will swarm when the weather is less than favorable.

After the swarm issues, some of the bees will alight on a nearby object and begin fanning with their scent glands exposed to attract the remainder of the swarm and the queen. Soon a "cluster" of bees forms. (It is this cluster—readily visible to the casual observer—that is correctly called a *swarm*). Scout bees will then depart from the cluster to find a new home site. When a suitable one is found, after a few hours to a few days, the swarm flies to the new site.

Bees in a swarm are usually quite gentle. Before leaving their old hive, they engorge honey and this seems to contribute to their gentleness. Another reason for their gentleness might be that, since the homeless cluster is only a temporary situation, the division of labor—including guarding—that prevails in a normal hive is either nonexistent or not as prevalent.

Swarm



Swarming vs. Productive Hives

Swarming used to be a sign of "good and productive" beekeeping since the beekeepers could make increases from the numerous swarms available. Straw skeps, logs, or other cramped hives used over a hundred years ago would soon become too crowded and promoted the swarming behavior of bees.

Today, swarming can be viewed as a sign of the beekeeper's negligence since it means a loss of both bees (unless the swarm is captured) and honey. Although most beekeepers make efforts to prevent or control swarming, it is not an easy task. The picture is further complicated by the fact that most methods used for controlling or preventing swarming result in manipulations that reduce the colony size.

Thus, although swarming can be controlled or prevented, in doing so the goal of maintaining populous colonies for the honeyflow is sacrificed somewhat. Nevertheless, this is far better than having the colony cast a swarm which may leave the apiary site before the beekeeper can recapture it.

Reasons for Swarming

Honey bee colonies swarm for any one or more of these reasons:

- congestion
- poor ventilation (perhaps due to lack of noontime shade)
- defective combs (those with too many drone cells or cells that are irregular, thick, damaged, or other-

wise not suitable for the queen to lay in, reducing broodnest capacity and increasing congestion)

- inclement weather, which keeps bees confined to hive and causes further congestion
- failing queen (instead of superseding the queen, the colony may swarm)
- queen pheromone production declines or amount of pheromone being distributed among a highly populous colony is not sufficient to control swarm preparations
- heredity
- idle nurse bees
- disease, like American foulbrood

Other Reasons that Bees Leave

Under certain conditions, the entire original colony may depart their home forever without leaving a new queen behind. This is called *absconding* and could be caused by:

- starvation
- disease
- wax-moth (or other pest) infestation
- fumes from newly painted or otherwise treated hives
- poor ventilation
- excessive disturbance of the colony by the beekeeper or vandals
- excessive disturbance by animal pests

Signs of Swarm Preparation

Signs that a colony is in some stage of swarm preparation are clearly visible

to a beekeeper on routine hive inspections. The list below is a rough chronology of the various signs one might see in a colony which may ultimately swarm:

- rapid increase in worker population (especially in spring—after a minor honeyflow and before a major honeyflow)
- drone rearing begins as worker numbers increase
- broodnest (area where eggs, larvae, and pupae are located) cannot be expanded due to combs already occupied with brood and/or honey
- queen cup construction at lower frame edges evident
- queen deposits eggs in these queen cups
- queen's egg-laying tapers off and amount of young brood decreases
- queen restless
- many queen cells containing larvae which vary somewhat in age
- field bees less active and begin to congregate at hive entrance; this can also happen if weather is hot or colony congested
- queen cells are capped or sealed
- swarm cast

Signs of swarming that are not readily observable are:

- queen begins to lose body weight in preparation for flight with swarm
- bees gorge honey

Signs of Imminent Swarm Issuance

A colony that has been making swarm preparations can be expected to issue a swarm:

- after queen cells (swarm cells) are sealed over
- when few bees are foraging (little flight activity of bees at hive entrance) compared to other hives of same strength
- when bees are clustered near the entrance—when not due only to hive congestion or high air temperatures
- during the warmest part of the day, usually between 9 a.m. and 3 p.m. (earlier or later if weather conditions are right)
- usually on the first warm, sunny, calm day following a short period of cold, wet, cloudy days when the congestion in the hives is aggravated

Clipped-Queen Swarms

A clipped queen will attempt to leave the hive with a swarm but, being unable to fly, will not accompany the other bees and will be left behind, usually on the ground near the hive from which she attempted to swarm. The swarming bees, without a flying queen, may return to the hive while they are still airborne, or they may cluster on the ground with the queen. They could also cluster without her and later move back to the old hive or to the queen on the ground. If the beekeeper witnesses any of these events, he can take steps to discourage their reoccurrence by the following procedure:

- Find and cage the queen either before or after the swarm returns.

- Move the parent hive from its stand and replace it with a new hive of foundation or dry drawn comb.
- When the swarm returns, let the queen walk in with them. If the swarm has already returned to the parent hive at the old location, shake half of the bees in front of the new hive; the bees will enter this hive; release the queen so she can walk in the hive entrance with the bees.
- Check after ten days.
- Requeen the colony, since the queen might have swarming instincts—the old colony, moved to another site, will have virgin queens emerging; the surviving virgin will mate and begin to lay. Since this colony might also swarm, all queen cells should be destroyed and the colony subsequently requeened.

Another method would be to let the swarm return to the original colony after removing the queen cells. Check after ten days to remove any queen cell construction, or Demaree the hive (see **SPECIAL MANAGEMENT PROBLEMS: Swarm Prevention Techniques; Demaree Method**).

PREVENTION AND CONTROL OF SWARMING

Swarm *prevention* is being practiced when a beekeeper is able to keep bees from initiating queen cup construction which may lead to swarming. Swarm *control* is employed when the beekeeper finds and removes queen cups and other signs of swarm preparations already evident. Although the times for initiating swarm prevention and control are different, the manipulations are the same. Such methods are discussed in the following sections including: relieving congestion by adding more room for the queen to lay or storage space for the growing bee population; separating the queen from most of the brood; and interchanging weak colonies with strong ones.

Reversing

Reversing the brood chambers, or lower hive bodies, at regular intervals or as needed beginning in the spring, is one method used to relieve congestion in the hive. Throughout the winter, the colony and its queen move upward through the hive (see **GENERAL SEASONAL MANAGEMENT: The Winter Cluster**); by spring, the cluster is usually in the topmost super (or supers) and since the queen may not move down, the brood will be confined there. Unless the queen, broodnest, and bees are put on the bottom with the empty hive bodies on top, the colony is likely to become congested and will probably swarm, even though there is expansion space below. Here is a quick outline for reversing hive bodies:

- Take an extra bottom board to the bee yard. Move the hive off its stand or from its location and place the extra bottom board in its place. Take the hive body containing the queen, most of the bees, and brood (#3 in illus.), and put it on the extra bottom board.
- Place at least one deep hive body (#2) above the broodnest (#3).
- If three hive bodies were present, place the third (#1) on top of other two.
- Clean the original bottom board and go to next hive.
- Repeat the procedure until all the hives are reversed.
- If the queen is reluctant to move up after a week, exchange a frame of brood from #3 with an empty frame from hive body (#2).

Relieving Congestion

Hives that are very congested due to poor combs or inadequate space for brood will be more likely to swarm. Listed below are some techniques for relieving such conditions:

- Add extra frames or supers full of foundation.
- Stagger supers slightly to allow for more ventilation.

Reversing

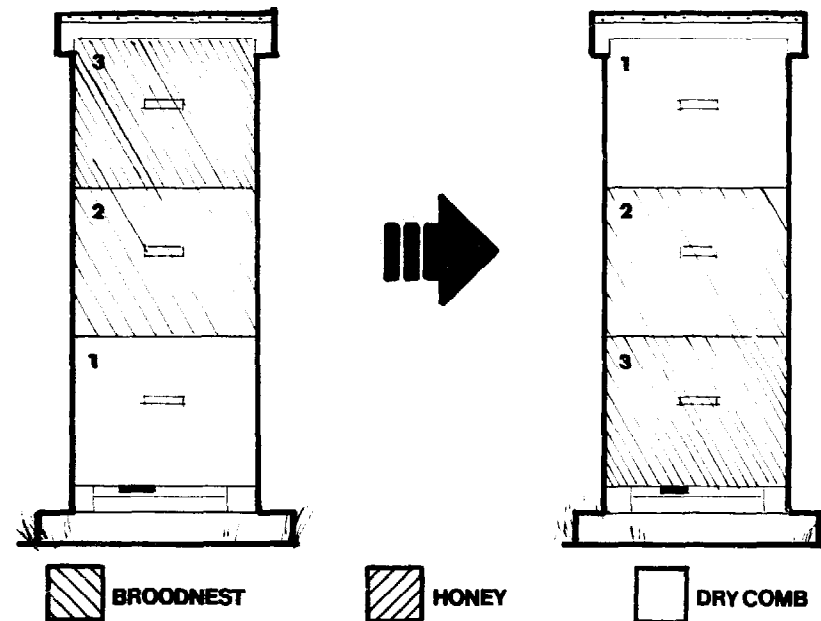

- Separate brood and queen:
 - Place the queen, with unsealed brood, eggs, and bees in the lowest super.
 - Above this, place a super with foundation.
 - Above this, place a super filled with capped brood and the rest of the bees.
- Decrease the number of bees or brood in the hive by splitting the hives to make additional ones, called *increases* (see illus.):
 - Place frames of capped brood and bees taken from several different hives into a new hive (one deep body).
 - If there is no food coming in, spray each frame of bees with syrup to reduce any fighting among the bees on the frames taken from different hives.
 - Give the new hive a frame of eggs from your best hive so they may make their own queen; *or*, requeen the split with a new queen; *or*, provide some queen cells (usually swarm cells).
 - Each increase hive should have four frames of brood, four frames of foundation and two frames of honey or empty drawn comb filled with syrup.
 - Reduce the entrance to discourage robbing and bees returning to their original hives; check after one week.

Interchanging Hives

In an apiary where the hives are in long rows, the bees tend to drift toward the row ends. As a result, the colonies in the middle may be weaker than the colonies on the ends (see *BEFORE THE BEES ARRIVE: Hive Orientation*).

If a hive is very populous and seems likely to swarm at some point but has not yet made preparation to do so, interchange it with a weaker hive (see illus.). This way more incoming, food-bearing foragers will return to the stronger hive's location but will enter the weaker hive, augmenting its population. Conversely, the strong hive will have a sudden decrease of incoming field bees, and any idle bees that might have normally initiated swarm preparations would soon be foraging. Foreign bees entering the switched hives should not fight if there is a honeyflow in progress. To decrease chances of fighting, wait for a good honeyflow before interchanging the hives.

Demaree Method

The *Demaree* method, made popular by a beekeeper of that name, allows one to retain the complete population of a hive while practicing swarm prevention and control. Basically, it separates the brood from the queen and decreases the congestion. Here is one way to Demaree (see illus.):

- Fill two deep bodies (#4 and #5) with frames of dry drawn comb from which brood has already

emerged.

- Foundation or a combination of both drawn comb and foundation can also be used; if no honeyflow is on, use less foundation since the bees will chew it; if you have only foundation, feed bees with syrup so foundation will be drawn out.
- Place these two hive bodies beside the hive to be Demarreed.
- Find the queen and place her on a frame containing very young larvae and eggs.
- There should be no queen cups or cells on the frame with the queen; if present remove them or replace the frame.
- Remove some dry comb frames or foundation from the middle of one of the new hive bodies (#4) and place the frame with the queen and clinging bees there.
- Add two or three frames of honey and pollen to #4 on the bottom board.
- Place a queen excluder above #4 and place body #5 (full of foundation or dry comb) above the excluder.
- Remove any queen cups from remaining brood frames and place them and clinging bees in #1.
- Any remaining frames of brood or honey without the clinging bees can be given to other colonies; any empty frames can be stored or placed in a super and added to a populous colony for additional room.

- After one week, cut out any new queen cups in the upper story (#1 or in #4).
- Two weeks later, if the queen's hive body (#4, below excluder) is congested and full of queen cells, remove the queen cells and Demaree again.
- One week later, remove any queen cells above the excluder.
- Fifteen days after the last manipulation, since the queen can't get above the excluder to lay, the top supers will be free of brood and will be used for honey storage or remain empty.

Variations of this method are used to rear queens (in warm weather), run a two-queen colony, or make increases; a division screen can be used in place of a queen excluder.

Advantages:

- population kept at a peak for honeyflow

Disadvantages:

- must find queen
- many manipulations necessary
- time consuming
- many trips to the apiary needed

Other Factors

In addition to the other techniques described, the following factors may also be of importance in helping to decrease swarming in some hives:

- young, vigorous queens
- queens raised from nonswarm stock
- hybrid queens with nonswarming tendencies

-ventilation—to increase air flow within a hive:

- hive bodies can be staggered
- inner or outer cover can be propped up
- bottom front entrance can be raised on small blocks
- these techniques might encourage robbing so only strong colonies should be manipulated in the ways described

Making an Increase (or Split)

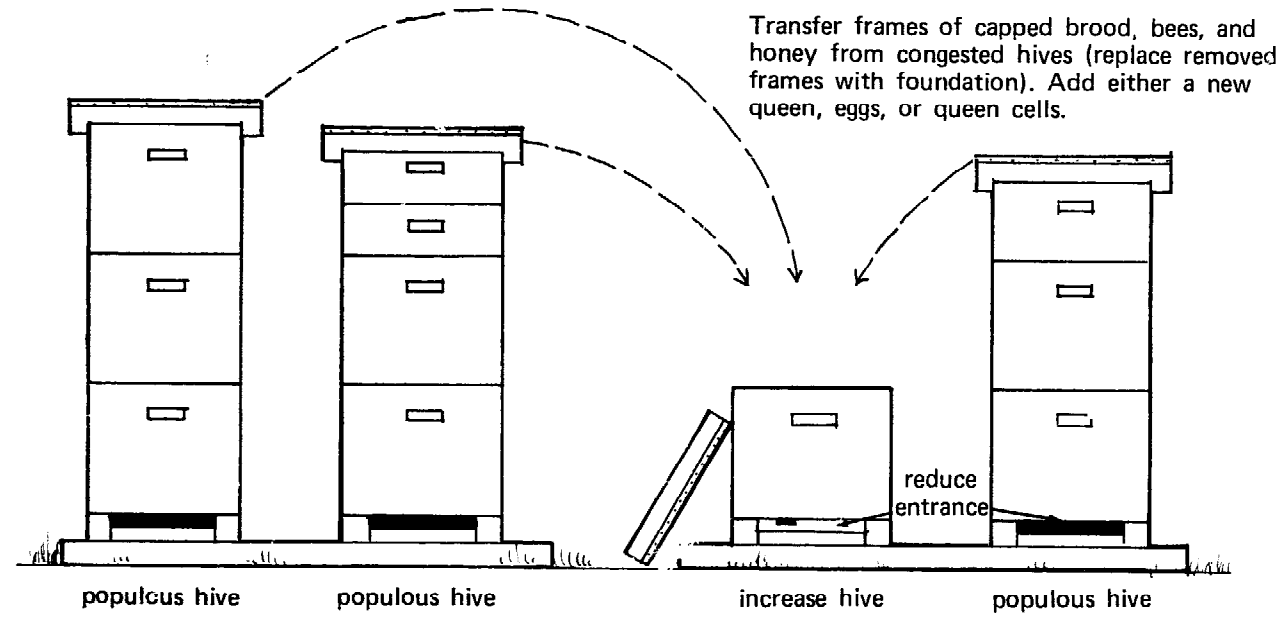

Demaree Method of Swarm Control

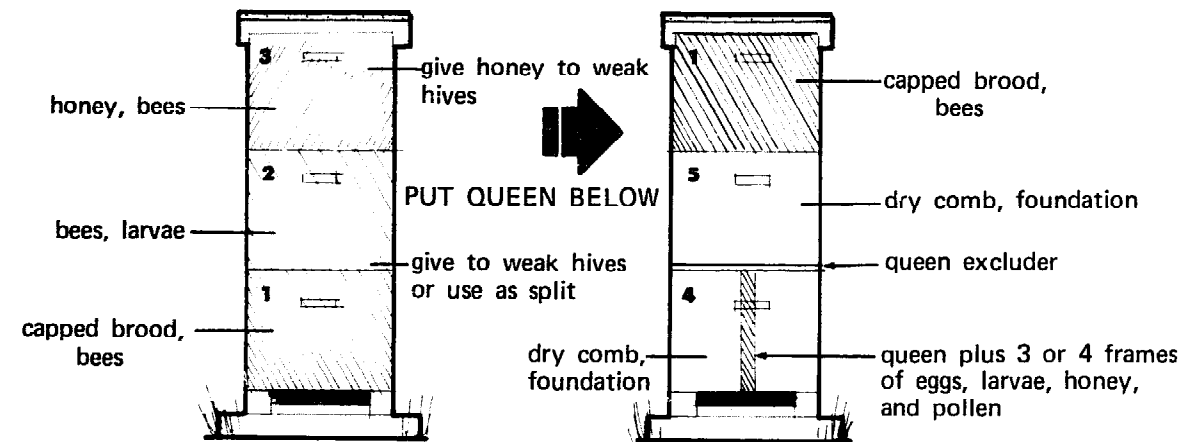

Interchanging Hives (Plan View)

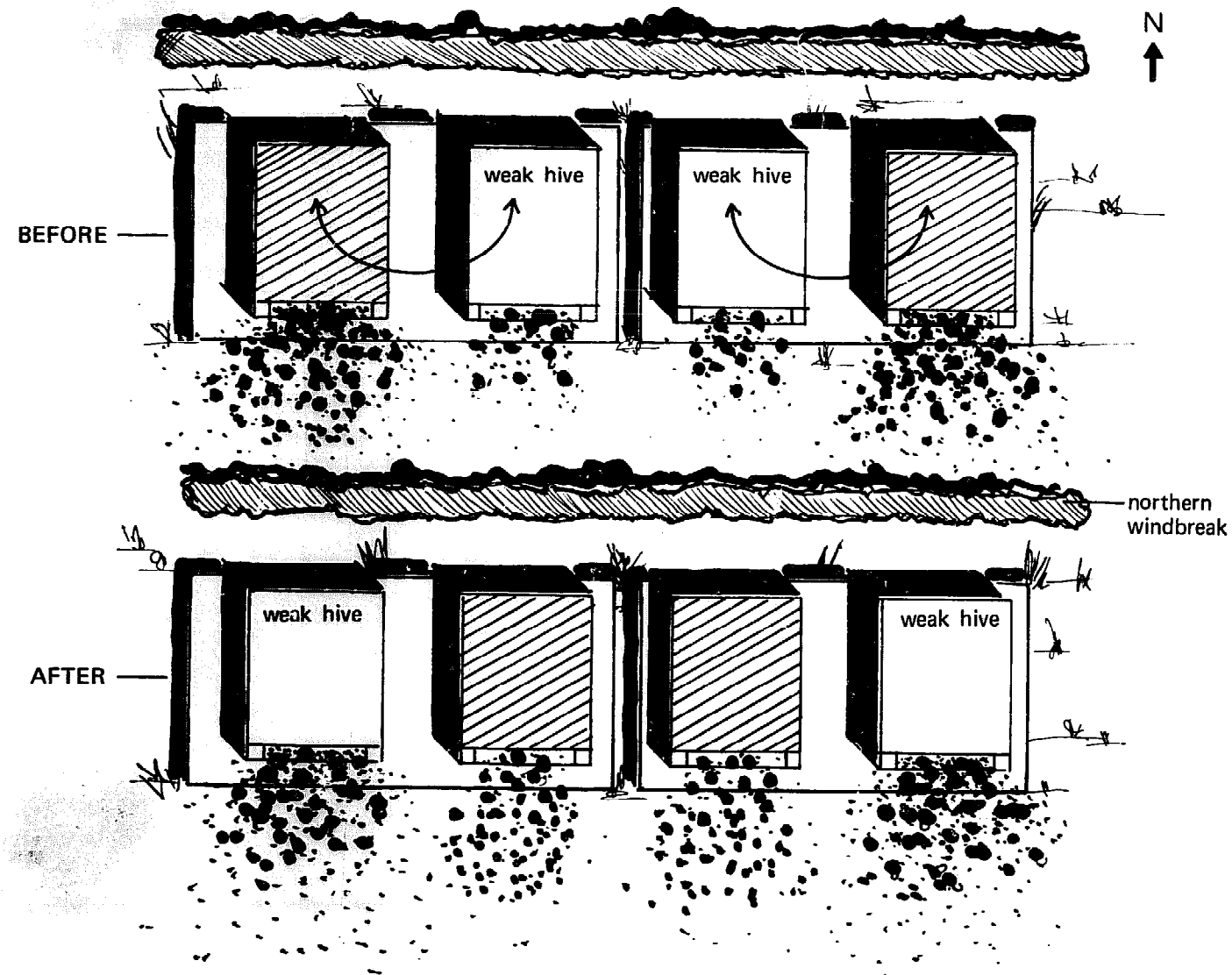

CATCHING SWARMS

Swarm Traps

It is generally not possible to check one's apiary on an hourly basis, and such attention to outyards throughout the swarming season is impossible. Despite good management procedures for swarm prevention or control, occasionally a colony preparing to swarm is overlooked. In addition, many beekeepers are constrained from devoting the time necessary for proper management. Thus, some swarming probably takes place in most apiaries. If one is not able to capture the swarm, the opportunity to increase one's holdings or to return the swarm to its hive is lost.

Some beekeepers who are unable to visit their apiaries frequently may attempt to compensate for their absence by capturing swarms lured to bait hives or by providing sites near the apiary for swarms to cluster. Such swarms can be readily seen and caught if they remain clustered until the beekeeper arrives. Some swarm traps are listed below:

- Decoy or bait hives—with drawn comb or foundation—can be placed at various distances and directions from the apiary. Wax, propolis, and other odors may attract the scout bees and, ultimately, the swarm, but they might also attract mice and wax moths, so any remaining bait hives should be removed at the end of the season.
- Low, dark objects close to the ground—such as a burlap bag wrapped around a low branch in a rough sphere—may attract a swarm to cluster there.
- Empty frames of old, dry drawn comb in tree crotches may attract swarms; be sure the combs are free of disease.

Some states have laws concerning the use of bait hives or restricting the use of exposed combs for baiting swarms. Find out what laws apply locally before using these techniques.

Swarm Containers

To be prepared the beekeeper should always have extra hives full of foundation for hiving swarms. If the swarms have to be collected some distance from the apiary, bring along a hive, or nuc box, with the bottom board stapled on. The swarm can then be shaken in front of the hive, and after most bees have entered the entrance can be closed with a piece of screen. The hive can then either be carried off or left there unscreened until the evening so that any stray bees can rejoin the swarm; its entrance should be screened when the hive is retrieved in the evening.

Other containers that can be used for collecting swarms are:

- a screened box, like an old bee package; shake the swarm into the box and

Hiving a Swarm

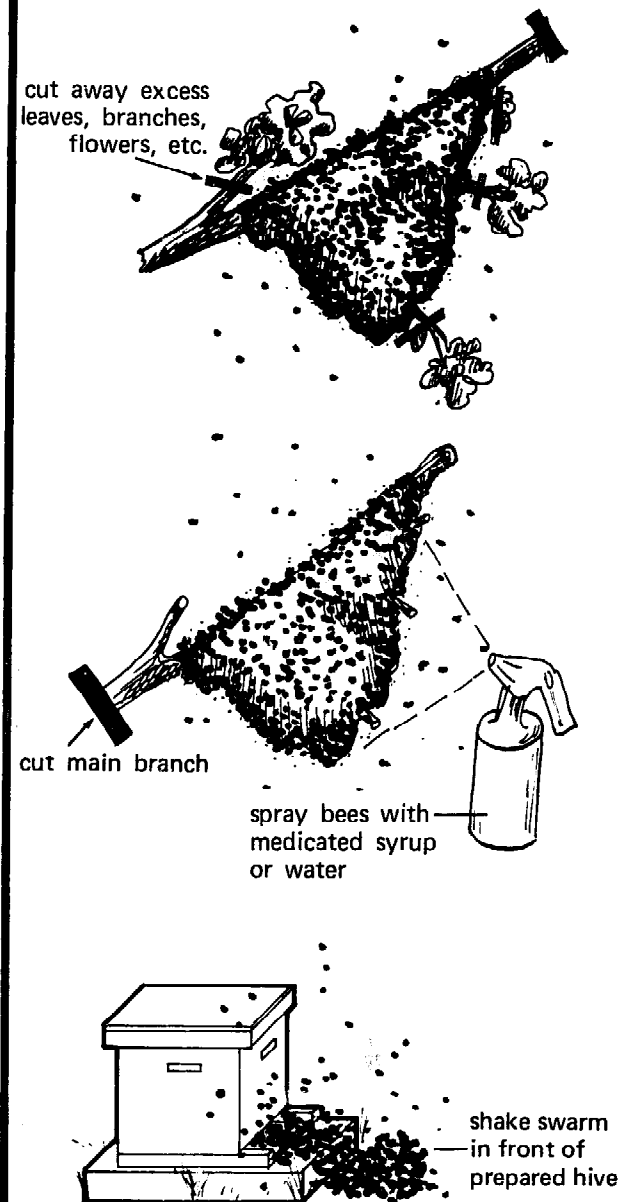

carry the box to the apiary

- a cloth bag (*not* a plastic bag); shake the swarm into bag and transport it to the apiary, or if the swarm is on a tree branch, envelope the swarm with bag, tie it closed, and cut the branch

Swarms, especially large ones, need plenty of ventilation and must be kept out of direct sunlight. Often bees are "cooked" or smothered when collected in inappropriate containers. A swarm in a temporary container should be stored, like a package of bees, in a cool, dark place until it can be placed in a proper hive.

Collecting and Hiving a Swarm

Beekeepers are often called by individuals, humane societies, and police and fire departments to retrieve swarms. If you wish to collect swarms to enlarge your apiary or strengthen weak hives, notify these agencies by letter or phone each spring and ask to be put on the "swarm list." Most beekeepers are thankful to get swarms and consequently pick them up without charge.

Swarms are usually well-gorged with honey and gentle. But sometimes a swarm is ill-tempered, especially if it has been clustered for several days and the bees are hungry. In any case, it is prudent to wear a veil when collecting swarms.

Some beekeepers carry spray bottles of syrup, often medicated syrup. Bees which are sprayed lightly with the syrup will gorge the food and become gentle and easier to handle. These are the basic steps for collecting and hiving a swarm (see illus.):

- If the swarm is clustered on a tree limb, with owner's permission, cut away excess branches, leaves, or flowers; avoid shaking or jarring the cluster.
- If the swarm is jarred and the bees begin to break the cluster, spray the bees and wait for the cluster to re-form.
- Saw or clip the limb above the swarm, holding the limb above the swarm to steady it while you cut; spray the swarm with syrup.
- Shake the swarm into a hive or collecting container prepared for them or, if possible, put the entire cut limb in the collecting container.
- If the swarm is on a post or flat surface, brush or smoke the bees into a hive or container, directing them gently with puffs of smoke.
- A piece of cardboard can be used like a dust-pan to gently scrape bees into the container or in front of the hive entrance.
- At the apiary, shake the bees from the container into a hive filled with foundation or unite the swarm with a weak colony.

If the swarm is to be united, its queen or the hive's queen should be caged (see *Care of Caged Queens*) while their performance is evaluated. If both are good, the extra queen can be used to make an increase or replace a poor queen elsewhere. Swarms united to colonies should be placed in a hive with foundation and then placed over the colony they are to be united with; they should not be placed in an empty hive body without frames as this will encourage the bees to cluster on the underside of the inner cover and construct comb.

Precautions

Swarms should always be treated as if they are diseased; that is, install them on foundation and feed with medicated syrup (see *BEE ENEMIES AND DISEASES: American foulbrood*). If a swarm is put on drawn comb, the bees may regurgitate drops of nectar containing disease spores from their honey sacs into the comb. By installing them on foundation, the bees will consume their honey sac contents first. Many of the bees in a swarm are usually young bees with active wax glands and will draw beautiful comb; if given drawn comb, much of this wax will be wasted.

QUEEN SUPERSEDURE

Supersedure is the colony's replacement of an old or inferior queen by a young queen. The workers in the colony build a few queen cells and when a new queen emerges, she destroys the other queen cells and may destroy the old queen (sometimes the mother queen is allowed to remain in the colony to die naturally). Swarming does not usually take place when a queen is superseded.

Some of the reasons for the supersedure of established, package, or introduced queens are listed below:

- queen is deficient in egg-laying
- queen has inadequate amounts of queen substance (pheromone) due to age, injury, or other physiological problems
- queen is injured as a result of clipping, fighting among virgins, or balling by workers
- queen was injured when removed from or placed into queen cage
- queen is defective or poorly mated
- queen has not been receiving enough nourishment (which may contribute to some of the above defects)
- colony has nosema disease
- inclement weather for extended periods (other than winter)
- after installation of a package, when numbers of adult bees decline and no new ones emerge for 21 days, the remaining older workers may undertake supersedure activities

SUPERSEDURE VS. SWARM CELLS

Young queen larvae can begin their growth in queen cells or in worker cells. Queen cells made from worker cells are often called *emergency* queen cells. The sudden loss of a queen usually forces the bees to modify worker cells into emergency queen cells, and as the larval queens develop, the cell's edges are slowly altered by the added wax which forms the peanut-shape characteristic of all queen cells.

Queen cells which begin from a cup-shaped base (queen cups) are either swarm cells or supersedure cells, depending on their location and numbers. *Swarm cells* usually hang from the lower edges of a comb, are numerous, and contain larvae of different ages (variation in cell size). *Supersedure cells*, on the other hand, are few in number, are usually located away from the comb edges, and contain larvae of approximately the same age (no variation in cell size).

A surviving queen that has emerged from a swarm cell usually replaces a queen that has departed with a swarm. A surviving queen that has emerged from an emergency queen cell replaces a queen that was accidentally lost.

The state of the colony and the time of the year may also indicate whether the colony's aim is to supersede or swarm.

In supersedure:

- the colony is usually not very populous
- the brood pattern is scattered or almost nonexistent due to a queen that is injured, diseased, or failing

- drone brood appears in worker cells
- queen cells are present after the normal swarming period

In swarming:

- the colony is populous
- numerous frames of capped brood are present, and there is a diminished number of cells with uncapped brood
- swarming season is on (late spring and early summer)

Emergency or Supersedure Cell

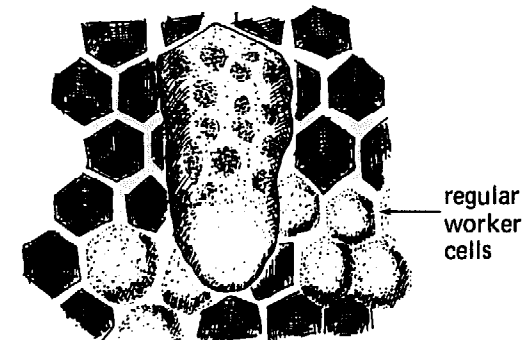

Swarm Cells

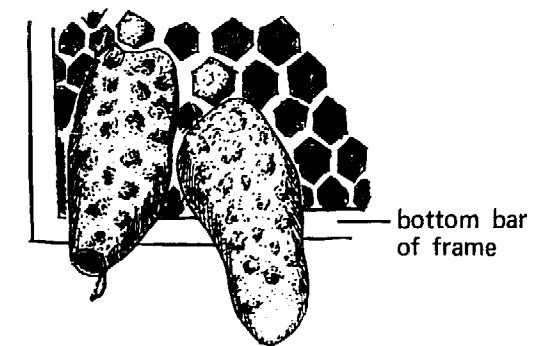

LAYING WORKERS

When a colony loses its queen and is unable to rear a replacement due to a lack of eggs or proper-aged larvae, some workers may start to lay. The ovaries of these females will mature and, after these bees are fed the high-protein royal jelly, eggs will develop. Since workers are incapable of mating, the eggs they lay will be only unfertilized or drone eggs. The worker population within a colony with laying workers, therefore, will slowly decline since the rearing of new workers stops with the loss of the queen.

To correct this situation, several methods have been developed, all of which involve the introduction of a queen, queen cells, or a frame containing larvae less than three days old. Often bees within a laying worker colony are first shaken from their frames at a distance of 100 yards from their hive just before the introduction of a queen, queen cells, or young larvae. Unfortunately, these attempts at rescuing a colony of laying workers from inevitable doom have never worked to anyone's satisfaction—frequently the colony will reject the introduced queen or queen cells, or it will rear workers rather than queens from the introduced larvae—and there is always the risk of losing valuable time. The best one can do is to unite a colony of laying workers with a queenright hive. Experimenting with various methods of requeening may be worth the experience, however—if one has no other colonies with which to unite a laying worker

colony and there is still time for the colony to build up its population and stores before the winter.

REQUEENING

Although queens may live for four years, the most productive queens are usually between one and two years old. Many beekeepers replace an older, existing queen with a younger queen annually or every other year (see *SPECIAL MANAGEMENT PROBLEMS: Marking or Clipping the Queen*); others replace only queens who perform poorly.

If the bees are preparing to swarm or supersede their queen, they are in effect requeening the colony themselves. This natural process of requeening is not beneficial to the beekeeper. Queen replacement as a consequence of swarming, for example, results in a loss of a portion of the colony along with the old queen, unless the swarm is captured and reunited with the colony. But because swarming traits are hereditary, that queen and colony might swarm again, as might the daughter queens in the old hive. Therefore, both the remaining colonies and any captured swarms should be requeened.

Queen supersedure, on the other hand, takes place only after the colony has been declining due to a failing queen (see *SPECIAL MANAGEMENT PROBLEMS: Queen Supersedure*). Her replacement may be inferior, especially if the colony numbers and stores are not adequate for rearing good quality queens.

The beekeeper should think of re-

queening colonies that show these tendencies:

- low bee populations for no apparent reason
- inferior queen, laying more drone than worker eggs
- unmated or injured queen, laying drone eggs or having some drone and worker larvae scattered over the comb
- diseased queen, brood, or workers
- aggressiveness
- excessive propolizing
- poor wintering success (very weak in spring)
- high honey consumption
- poor honey production
- high tendency to swarm

Types of Queens

Queens can be obtained by:

- purchasing
- raising one's own
- obtaining them from colonies preparing to swarm or supersede their queen

Queens can come from any one of four categories:

- virgin queens
- untested queens (have been observed to lay)
- tested queens (have been retained in mating boxes until the first brood emerges in order to determine purity of mating)
- select-tested queens (have been placed in colonies and tested not only for purity of mating but for

other characteristics such as disease resistance, gentleness, and productivity)

Care of Caged Queens

Mated queens, packaged in *Benton mailing cages*, are mailed from dealers to all parts of this country and to some other countries. Some of the procedures for notifying the postal service when awaiting bee packages should also be followed when queens have been ordered.

When the queens arrive, they should be properly cared for. If the cages contain candy and four or five attendant bees, they can be kept in a warm, dark place free of drafts for a period of about two weeks. Each cage should be provided with a small drop of water twice a day. If the queens are to be introduced by the "Indirect Method" described in the following sections, the attendant bees should be removed beforehand.

To store caged queens for longer periods, first remove the attendant bees, then place one end of the cage against the under side of the top bar of an empty frame (without comb or foundation) and rest the other end on a bar of wood which has been nailed in to run the length of the frame (see illus.). The frame with the caged queens can be inserted into a queenless colony or into a queenright hive above a queen excluder. The queens will be cared for until they are needed. A free queen must not be allowed in the queenless colony or above

the excluder, otherwise the caged queens may be killed.

Seasonal

Requeening can be done in the spring, summer, or fall. It is preferable to requeen during a honeyflow, since a colony is almost certain to accept a new queen when food is coming in.

Spring Requeening

Advantages:

- colony less likely to swarm
- vigorous egg layer will produce strong bee populations for subsequent honeyflows
- colony will enter winter with a large population
- old queen easier to find since colony numbers are low
- bees calm, less prone to sting or run
- plenty of time to assess queen's performance and to change her if necessary

Disadvantages:

- queen more costly to purchase
- dependent on weather
- queen could be superseded if inclement weather sets in

Summer-Fall Requeening

Advantages:

- queen less expensive
- less chance of swarming the following year
- colony enters winter with a strong

population

- colony emerges in spring with high bee population ready for honeyflow and/or increase

Disadvantages:

- hive populous
- old queen difficult to find
- if no honeyflow is on, bees prone to sting and run when hive is opened
- time consuming
- in fall, fewer opportunities to check if queen was accepted if weather turns inclement
- less time to assess queen's performance
- could end up with queenless colony and laying workers

QUEEN INTRODUCTION

Although many methods, including some ingenious ones, have been devised for introducing queens into colonies for the purpose of requeening, none can guarantee absolute success. Often the more time-consuming ones are the most likely to succeed.

It is generally agreed that no matter what method is employed, the most opportune time to requeen is during a honeyflow. All the methods listed here, except the *division-screen* method, require that the hive be *dequeen* (queen taken out to make hive queenless) from 2 to 24 hours prior to the introduction of the new queen. The methods used can be divided into two categories:

- Indirect Release, where there is a delay before the bees have direct access to the queen, and
- Direct Release, where the queen is immediately released among the bees.

Some of these methods can be combined with swarm control or making increases in the apiary (see *SPECIAL MANAGEMENT PROBLEMS: Swarm Control Techniques*).

Smoke should be employed in the same fashion as when ordinarily working with the bees. It may be worth the time to feed the colony with sugar syrup a few days before and after killing the old queen to mimic a honeyflow and increase the likelihood of the bees accepting a new queen.

Indirect Release

This method of requeening employs the Benton queen cage (shipping cage):

- Dequeen the colony 2 to 24 hours prior to replacing with new queen.
- Remove the attendant bees. One way of doing this is to remove the cork opposite the candy end of cage while standing in a darkened room next to a closed window; when bees fly out toward the daylight, recapture the queen from the window; picking her up only by the wings or thorax, return her to cage and replace the cork. Attendant bees in a queen cage should be removed since they and the bees in the hive may fight. As they encounter each other and start struggling, an alarm pheromone is released in the vicinity of the cage. Such a signal may stimulate other hive bees to congregate in the area and they may begin to bite and ball the queen.
- Remove the cork in the candy end and make a small hole through the candy with a nail to make it easier for the bees to free the queen. The hole should not be too large since one of the purposes of the candy plug is to delay the queen's release and thus enhance her acceptance.
- Wedge the cage, candy-side up, between two top bars of frames with young larvae, making sure the screened side of the cage is accessible to the bees.
- Examine the colony after one week; if the queen is still in her cage poke a bigger hole in the candy or release her directly (see *STARTING BEES FROM PACKAGES: Installing Packages*).

Other Types of Cages. Although the Benton queen cage is used most often for requeening, many other types of cages for queen introduction have also been invented.

The *push-in cage* can be made by folding all four edges of a piece of hardware cloth or screen at right angles to form a box without a top. After the colony has been dequeen, the open end of the cage is pushed into a section of comb over a newly obtained queen (see *illus.*). Such a section should contain capped brood, a few cells of honey, and no adult bees. After seven days, release the queen by removing the push-in cage. Some beekeepers cut a hole in one of the corners of this cage and plug it with candy made from a small amount of honey mixed with confectionary (powdered) sugar; the bees will release the queen after eating through the candy.

Push-In Introduction Cage

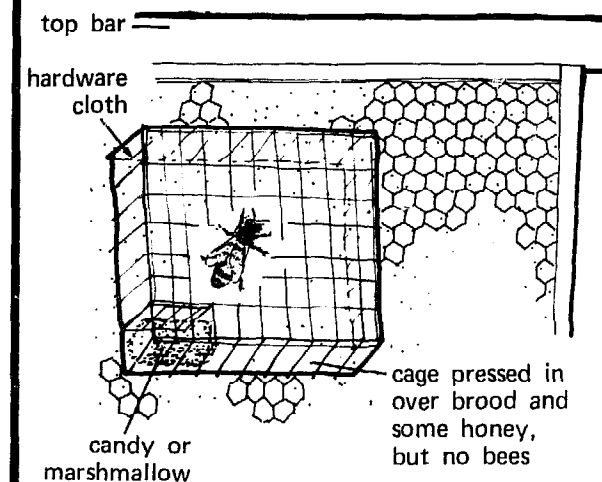

The *Chantry cage*, also commonly used for queen introduction, consists of a compartment for the queen and two tunnels plugged with candy. One tunnel leads to a piece of queen excluder and the other, when the candy is chewed through, frees the queen from her compartment.

It is always helpful to talk with experienced beekeepers about their success with these different cages before using them.

Direct Release

Nucleus Method. Dequeen the colony at least one day in advance, then proceed as follows:

- Place a well-populated nucleus box containing three to five deep frames of bees and a laying queen next to the dequeened hive.
- Apply a small amount of smoke into the nuc entrance, being careful not to disturb the bees too much.
- Remove the nuc cover to air out the smoke.
- Remove two to three frames from one side of the dequeened hive and replace them with two to three frames of bees and laying queen from the nuc box; the laying queen should be between two of the inserted frames.
- Close the hive and check after one week.

If the nucleus colony is exceptionally strong, use it to raise another queen

by giving it a frame of uncapped larvae and eggs from your best hive (see *Queen Rearing*). You may also introduce another laying queen into the nuc, either by the Indirect or the Direct Release Method, so that it may be united with a weak hive later (to requeen it) or to make an increase with the nuc.

Honey Method. Dequeen the colony at least a day in advance then proceed as follows:

- Open the hive and remove nearest frame; check each frame until you find one with young larvae and honey; remove it, shaking off all adult bees.
- Break the wax seal over some honey and, without injuring the new queen, coat her with honey.
- Release the queen on the frame with young larvae and then gently replace the frame into the hive; replace remaining frames and close the hive.
- Check for the queen after one week.

Scent Method. The scent method employs a scented syrup (peppermint, lemon, vanilla, mint, onion, anise oil, or grated nutmeg) which temporarily masks the odor of the introduced queen. As the scented odor gradually diminishes, the queen's scent eventually replaces it, causing the bees to accept her more readily. Dequeen the colony at least a day in advance, then proceed as follows:

- Spray both the frames containing bees and the new queen with the scented syrup, but do not soak

the bees.

- Be sure to spray all frames with bees.
- Release the queen on the top bars.
- After she has crawled down between the frames, close hive; check after one week.

Smoke Method. Dequeen the colony at least a day in advance, then proceed as follows:

- Reduce the entrance to 1 inch with loosely packed grass.
- Blow four or five strong puffs of smoke into the entrance.
- Close the entrance for 1 to 2 minutes.
- Open the entrance slightly to allow the queen to enter; smoke a few puffs after she enters.
- Close the entrance for 3 to 5 minutes.
- Reopen the entrance after 15 minutes to about 1-inch wide (the bees will remove the remaining grass within a few days if it is loosely packed).
- Check for the queen after one week.

Caution should be used with this method if the weather is extremely warm since a reduced entrance will make it difficult for bees to ventilate the hive.

Shook Swarm Method

Dequeen the colony at least one day in advance, then proceed as follows:

- Take out frames with bees on them and spray bees and frames with syrup.

- Shake these queenless bees into a screened box, old bee package, or swarm box (the container should be large enough so bees are not overcrowded and should be screened for ventilation); after the bees have been "shook" off the frames into the container, any frames with brood should be given to another (weaker) colony. The empty hive should be closed to prevent robbing of remaining frames of honey.
- Put the bees in a cool, dark place and feed them with 1:1 sugar syrup as needed (see *STARTING BEES FROM PACKAGES: When the packages arrive*).
- Seven to eight hours later, introduce the queen into the container; she can be sprayed, along with the bees, when introduced; a scented syrup can even be used.
- After one hour, reopen the old hive and install the bees as you would a swarm.
- Or, the queen can be put into a queen cage, and the bees and queen can be installed by the Indirect Release Method for Packages (see *STARTING BEES FROM PACKAGES*).

Division-Screen Method

A division screen is a double-screened, rimmed partition which has a small entrance on one side of the rim (see illus.). It is used to make an increase or to start a two-queen colony or a split; the screen

separates the queen and bees in a lower hive from the queen cells or new queen and bees in a hive placed above. This way, the smaller colony above can take advantage of the heat generated from the colony below.

To requeen by this method, follow these steps:

- Remove from any strong hive(s) three or more frames of capped brood from which bees are emerging.
- Shake the frames to remove all adult bees.
- Place the frames of brood in the center of an empty hive body (#3 as illustrated).
- Place frames of sealed honey with some pollen on each side of the brood frames.
- Fill the remaining space with frames of dry comb.
- Place the division screen above the broodnest of the hive that is to be requeened.
- Place the hive body with honey and brood above the division screen; heat from the colony below will keep the emerging brood warm.
- Requeen the top hive body with a queen cell or a queen (by any method). As the young bees emerge, they will accept the queen as their own.
- The entrance of the division screen should be small so only a few bees can pass through at one time; close this with loosely packed grass for a week until the brood emerges.

- Check hive after one week.
- Three weeks later, replace the division screen with a queen excluder. The hive can now be run on a two-queen system until after the honeyflow, or the hives can be united by removing the excluder just before a major honeyflow. Find and remove the older queen; otherwise, just unite the colonies by removing the excluder.

Division-Screen

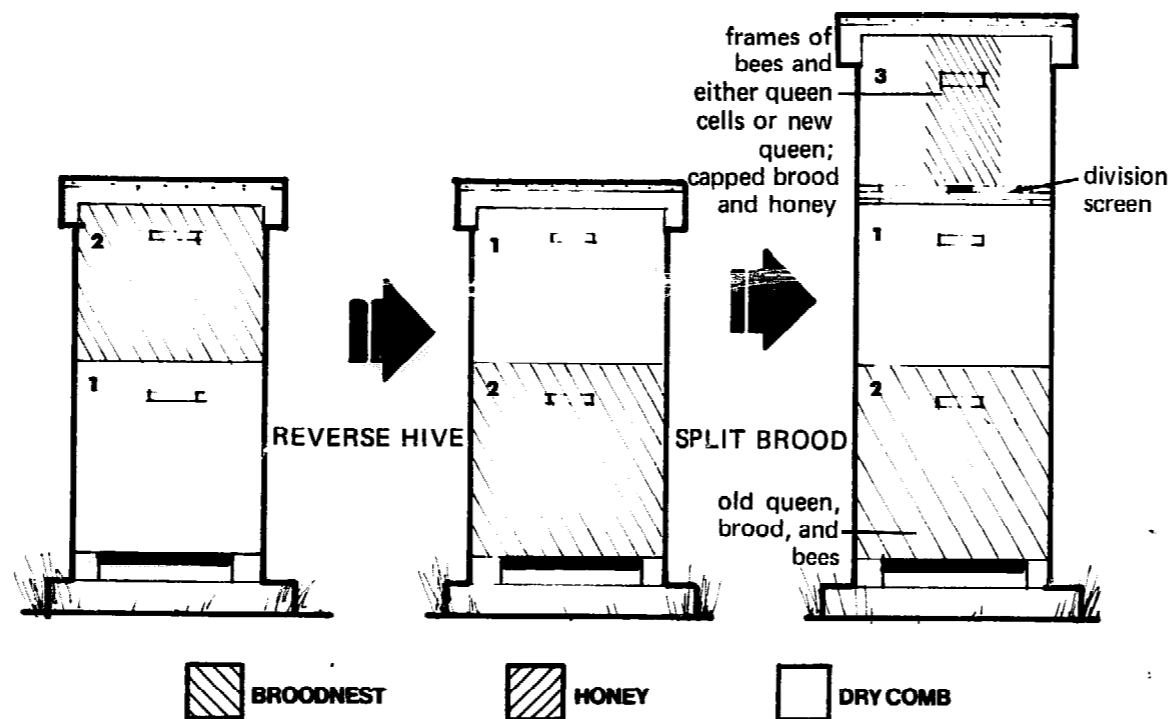

REQUEENING AGGRESSIVE HIVES

Occasionally, a colony of bees becomes unusually aggressive despite the beekeeper's best precautions. These colonies make one's work more difficult, and if the bees are extremely aggressive, they could adversely affect the behavior of other colonies due to excessive amounts of alarm pheromone released whenever this aggressive colony is worked.

The best way to deal with such a colony is to requeen it. After it has been successfully requeened, the change in the behavior of the colony will be apparent as soon as the new queen's offspring populate the hive.

Finding the queen of an aggressive hive poses the major problem in getting it requeened. Here is one method of requeening called the *Non-Shook Swarm Method*:

- During a honeyflow, on a very favorable day, move the colony to a new location.
- In the old location, put an empty hive body on a bottom board, and place one frame of young larvae in it. Fill the remaining space with dry, drawn comb; put on inner and outer covers.
- Field bees from the aggressive colony will return to the old location and the new hive; with old colony's population reduced, it will be more manageable.
- Find the old queen and remove her.
- Introduce the new queen by any method you choose.

- Wait seven days, then check to see if the new queen has been accepted.
- Return the original hive to its old location and unite it with the small hive, or unite small hive with original hive at its new location.

The colony can also be requeened at its original location without these steps if the queen can be found quickly. If the hive is too populous, split it, wait four days, then dequeen the split. Requeen one or both splits or unite them after one has been successfully requeened. The non-shook swarm method can also be used to requeen hives that are not aggressive.

QUEEN REARING

Letting Bees Raise Their Own

Some beekeepers prefer to raise their own queens rather than purchase them from a commercial breeder. While educational and exciting, the rearing of queens can be tricky, time consuming, and often unsuccessful.

A superb queen can probably be found in any apiary with two or more colonies. Obviously, if queens could be raised from the larvae of such a colony and later be introduced successfully to other colonies, the entire apiary could be upgraded. However, if bees are inbred they deteriorate rapidly. Good queens are reared by bees of a strong

colony when there is an abundance of food (honey, sugar syrup, and pollen) available to the nurse bees.

The easiest, but not necessarily the best way, of obtaining queens is to provide a strong queenless colony with a frame of larvae less than three days old taken from a colony with desirable qualities or to take queen cells from those good colonies preparing to swarm or supersede their queens.

Advantages:

- easy
- inexpensive
- will succeed in obtaining queens
- few manipulations needed

Disadvantages:

- loss of brood in dequeened hive
- queen could be inferior
- may disrupt hive (if it is dequeened)
- queen might mate with inferior drones

Miller Method

The Miller Method of queen rearing may be the easiest for the beginner. Prepare an empty brood frame by fitting it with four pieces of foundation, 2 inches wide and 4 inches long (see illus.). Cut the unattached lower half of each strip of foundation to form a triangle with its apex pointing downward. Do not wire foundation to frame.

- Remove all but two frames of sealed brood from a hive whose queen is of superior quality.
- Insert the prepared frame between

the two frames of the sealed brood.

- Make sure the queen is on one of the frames.

- On either side of the brood frames, fill the hive with frames of honey and pollen (there should be no empty cells in these frames, otherwise the queen may lay in them).
- The queen will be forced to lay in the prepared frame as soon as cells are drawn.
- About one week later, remove the prepared frame; trim away edges of the newly drawn pieces of foundation until you encounter cells with small larvae (preferably less than a day old, but never more than two days old).
- Dequeen colony to be requeened 24 hours before it is to receive Miller frame. The next day remove all frames with open brood from dequeened colony (or at least frames with young brood).
- Insert the Miller frame into the dequeened colony and place a frame of older larvae next to it; insert some frames of pollen and honey; the young larvae on the Miller frame will receive ample care and royal jelly.
- Nine days after inserting the Miller frame, remove the sealed queen cells by cutting them from the Miller frame and attaching them to combs in queenless hives or nuc boxes.
- Queens from these nuc hives will

hatch and mate. These queens can then be left in the hives from which they mated or used for re-queening after they have begun to lay eggs.

Notes

Queen-Cage Holding Frame

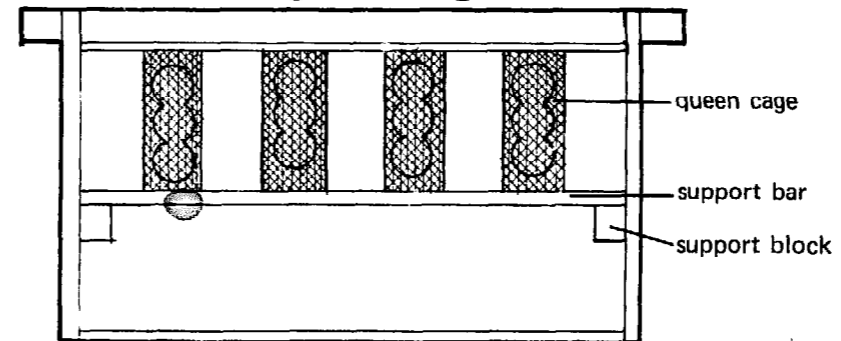

Doolittle Frame for Queen Rearing

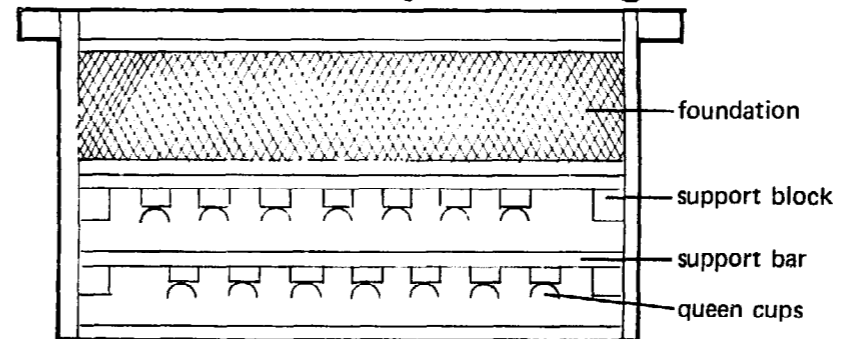

Miller Frame for Queen Rearing

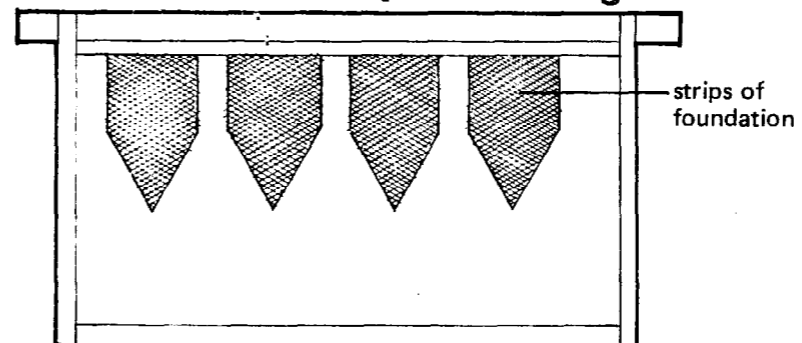

Doolittle Method

This method is much more difficult than the Miller Method, but many queens can be reared at one time. See also the *REFERENCES: Queens* for more information on available books on the subject.

Before beginning, several queen cups (wax cells) and their bases (wooden cell cups) should be made or purchased.

- An empty frame is fitted with a strip of foundation 3 inches wide.
- A wooden bar is fitted into the frame just below the free end of the strip (see illus.).
- Wooden cell cups with wax queen cups inserted in them are attached with beeswax to the underside of the wooden bar.
- Two days before transferring larvae to these cups, dequeen a strong hive and feed it with syrup.
- On the third day, shake the bees off every brood frame in the dequeened hive and remove all queen cells; these cells will provide you with royal jelly.
- Rearrange the frames in the dequeened colony so that the lower chamber has mostly sealed brood; the upper chamber should have (in order) a frame of honey, two frames of older larvae, a frame of young larvae, space for a frame with queen cells, a frame of pollen, one of older larvae and one of honey.
- Remove a frame of larvae less than three days old (larvae 24 hours old or younger are ideal) from a hive with excellent genetic attributes.
- Prime the queen cups with royal jelly, scooping the jelly from the previously cut queen cells, into the queen cups.
- Transfer the larvae with a grating tool or toothpick (with one end carved flat and curved slightly upward) from worker cells to the primed queen cups; the larvae should be placed on top of the royal jelly in the same position they were in before the transfer.
- Insert the frame, with queen cups containing transferred larvae, into the dequeened hive.
- Continue to feed the queen-rearing colony with sugar syrup.
- Nine days after inserting the queen cups, transfer the ripe queen cells, one to each nucleus box, queen nucs, or hives—all of which contain bees that have been queenless for two days; these bees will continue to incubate the queen cells. After the queens have emerged, they will fly out and return mated: they can then be used where needed.

TWO-QUEEN SYSTEM

Some beekeepers use two-queen systems of colony management to improve honey yields. Two separate colonies one above the other (each with its own queen) are joined, but a queen excluder is placed between them to protect each queen from the other. There are various methods of managing hives with two queens; here is one method:

- Split a very strong colony and requeen the upper queenless portion by the division-screen method, placing only capped brood above the screen.

Or:

- Place a division screen in a strong hive between two hive bodies of brood with the original queen below (see *SPECIAL MANAGEMENT PROBLEMS: Swarm Prevention Techniques; Relieving congestion*); introduce a new queen to the upper chamber or provide it with queen cells.
- After the queen above the division screen (#3) has been accepted and laying for two weeks, replace the division screen with a queen excluder.
- The hive should be comprised of the following parts (see illus.):
 - one deep with original queen (#2)
 - one shallow or deep above original queen (#1)
 - division (board) screen
 - one deep with new queen (#3),

- inner cover, and outer cover
- Super for honey both above and below the excluder.
- Remove the excluder in the fall and either kill the less desirable or older queen or let them fight it out.

Advantages:

- better yields since one large colony will produce more than two separate colonies, each having half the strength of the large one
- more bees which can be used later for making an increase or for strengthening weak hives
- strong hive for wintering
- if one queen fails, hive has a back-up queen
- can be combined with requeening and swarm control techniques

Disadvantages:

- even if all manipulations are completed successfully, will not be effective if local honeyflows and colony are not synchronized
- time consuming
- difficult to manipulate
- hard to make work successfully

Two-Queen Colony Manipulation

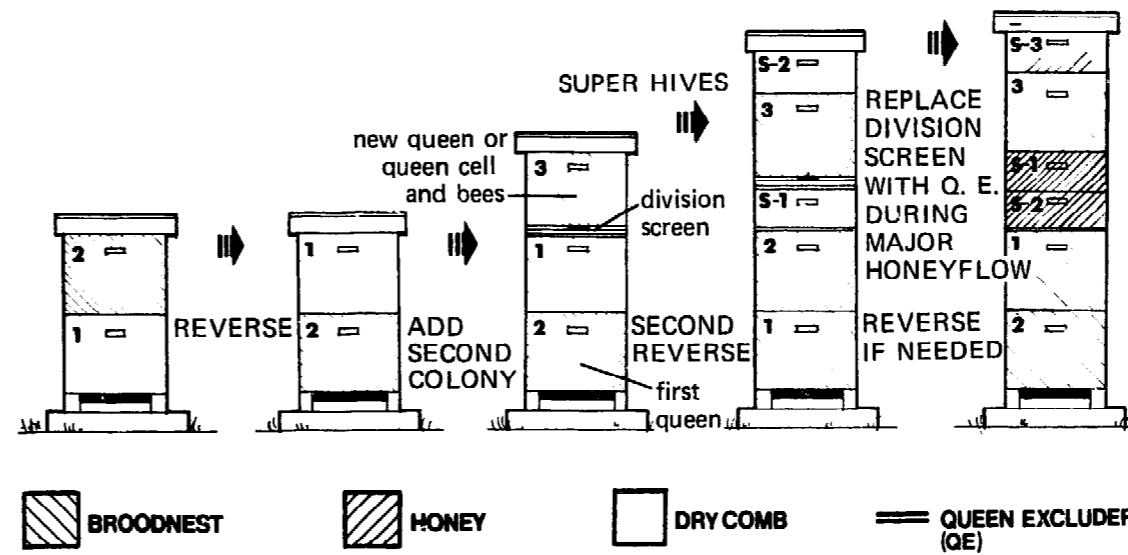

Products of the Hive

HONEY

The Honey House

A sanitary honey house for extracting, bottling, or otherwise handling honey, should include the following necessities:

- hot and cold running water
- washable floor (concrete or ceramic tile) with center drain
- screened windows with bee escapes installed to allow bees in house to escape
- storage space for empty supers in an unheated portion of building
- electricity
- work areas for constructing and repairing frames, supers, and such
- dehumidifier
- storage tanks for honey

Though not essential, the following equipment may also be stored here:

- uncapping knives
- extractor
- capping tank or tray
- honey pumps
- straining cloths
- capping baskets
- screen to drain cut comb honey
- bottles and labels
- holding tanks

Beekeepers with fewer than 200 colonies can easily manage to get by with an extractor, uncapping knife, and some additional equipment.

Chemistry

Among other things, nectar contains sugars and water. The water content of nectar is high and has to be reduced in order to make and enhance the preservation of the final product—honey. Bees returning to the hive with sugar-water solution, release small portions of the solution from their honey sacs onto the bases of their proboscis, or tongue.

Small amounts of the ripening nectar are then placed in cells—usually by the hive bees—where further evaporation of its water content takes place. Warm air circulating in the hive, fanned by other hive bees, helps speed reduction of the water content of these sugar solutions. Staggering honey supers by about 1/4 inch or so during the honeyflow will increase the ventilation and quicken the ripening process. Once a frame of honey has been at least three-quarters sealed with wax cappings, it can be removed from the hive and processed.

Nectar from flowers generally consists of 60 percent water and 40 percent sucrose. The sucrose is altered by the action of a bee enzyme called *invertase*, which breaks sucrose into the two simple sugars (carbohydrates) called *dextrose* and *levulose* (glucose and fructose). These two sugars are the principal components of honey, with levulose predom-

inating over dextrose. Other sugars that remain after invertase activity include small amounts of sucrose and a dozen other complex sugars.

In addition to sugars and water, honey contains enzymes which alter other molecules by reducing or increasing their molecular size. Important enzymes in honey include invertase and *glucose oxidase*, the latter reacting with dextrose to produce *gluconic acid* and *hydrogen peroxide*. The factors which endow honey with antibacterial properties include the hydrogen peroxide, the high sugar content (about 80 percent), and the high acidity.

When honey is reduced to ash, trace amounts of minerals are found. They are: calcium, chloride, copper, iron, magnesium, manganese, phosphorous, potassium, silica, sodium, and sulfur. Other components of honey are acids, proteins, amino acids, and vitamins—all in trace amounts.

Forms of Honey

Honey sold in stores is either *extracted* and bottled or sold in the *comb*. Extracted honey removed from the comb is packaged in liquid form (which will ultimately granulate, or crystallize, if not treated) or is purposely packaged in the crystalline state. Extracted honey is further classified into colors ranging from *water white* (light yellow) through *amber* (gold) to *dark* (black). The lighter the honey color, the milder the flavor.

Comb honey remains in the wax honey comb where it, too, may ultimate-

ly granulate. The basic types of comb honey are:

- section comb, consisting of individual wooden boxes (sections) or circular plastic rings (Cobana)
- cut comb, where the entire comb is removed from the frames (bulk comb) or sections are cut out of the frame (cut comb) and packaged
- chunk comb, where sections of cut comb are placed in a bottle which is then filled with liquid honey

Extracting Honey

Supers with honey ready to be extracted should be placed in a bee-tight room or honey house. If the room temperature is about 90°F (32.2°C), the honey can be extracted with ease. Let the supers stand in a warm room until the honey is room temperature. Avoid storing supers in temperatures below 57°F (13.9°C) since this tends to promote the granulation of honey.

The wax cappings which seal the honey in the cells are commonly cut away with a steam-heated or an electric uncapping knife.

- Cut the cappings off both sides of the honey comb, letting the cappings drop into a screened basket or onto some other device which will permit the honey to drain off the cappings (see illus.).
- Place the frames into an extractor (radial or basket-type). Note:

frames with unequal amounts of honey may cause the extractor to vibrate due to the unbalanced weight distribution.

- If using a basket-type extractor, start with a slow spin and gradually increase the speed; spin the frames on one side for three minutes, then reverse them and spin on the other side for three minutes.
- If using a radial extractor, there is no need to reverse frames—both sides of the frame are extracted simultaneously. Start with a slow spin and gradually increase speed; start at about 150 revolutions per minute increasing to 300 revolutions per minute. Spin at the maximum rate for about 15 minutes.
- The honey may be drained from the extractor while it is spinning.

After Extracting Honey

Extracted honey should be strained to remove wax, bees, and debris. The strainer can be made of nylon, screen, or cheesecloth—any material that is easy to wash and will not clog too easily.

After extracting:

- Place the strained honey into a holding tank until it can be put into other containers.
- Remove the empty, wet frames from extractor and place them in empty supers; return these to hives at dusk to allow bees to clean the wet frames. If no other honeyflows are anticipated, remove

the cleaned supers after a day or two and store them.

- Extracted combs should not be stored wet since remaining honey will crystallize in the cells and hasten the granulation of next year's crop.
- Remove as much honey as possible from the cut cappings and then melt the wax cappings down.

Properties of Honey

Hygroscopicity. Hygroscopicity is the ability of a substance to exchange moisture with the air. Honey will absorb moisture when the relative humidity in the storage area is above 60 percent. In low humidities honey will give up moisture to the air. The hygroscopic nature of honey is due to its sugars. This property of honey is beneficial to the baking industry since it helps keep baked goods that contain honey moist and soft. On the other hand, if honey incorporates too much water (more than 17 percent), sugar-tolerant yeasts will spoil the honey by causing it to ferment.

Fermentation. Sugar-tolerant yeast spores (osmophilic) under certain conditions are able to germinate in honey and metabolize sugars. As the sugars of honey are metabolized, the yeasts produce high energy molecules and the by-products (alcohol and carbon dioxide) which spoil the honey. Probably all honeys contain osmophilic yeasts and conditions which determine whether or not these spores will germinate and multiply, include:

- water content of the honey
- temperature at which the honey is stored
- number of yeasts in the honey
- the granulation of the honey, which results in an increase in the water content of the remaining liquid portion

Fermentation of honey can be prevented if its moisture content is less than 17 percent, if it is stored at temperatures below 50°F (10°C), or if it is heated to 145°F (62.2°C) for 30 minutes.

Granulation. Most honey will granulate after being removed from the comb; some honey granulates just a few days after being extracted, while other honey remains in liquid form for weeks, months, and even years. In order to keep most extracted honey in a liquid state, it has to be heated to 145°F (62.2°C) for about 30 minutes. Honey that is allowed to granulate naturally can lead to fermentation, or granulation with undesirably large crystals; partially granulated honey is often considered "spoiled" by the uneducated consumer but is, in fact, perfectly good to eat. Many honey producers granulate honey by a method called the Dyce Process and sell it as a spread; this honey has very fine crystals and does not ferment. The ideal temperature for honey to granulate is 57°F (13.9°C)—unless the object is to produce this kind of honey, all honey should be stored above this temperature.

Honey Extractors

Radial extractor

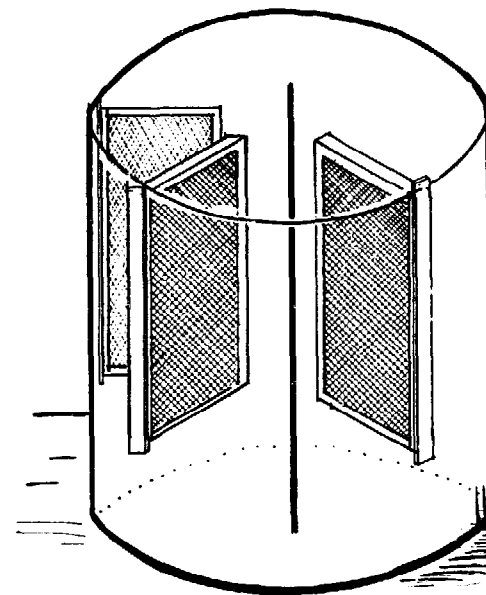

Basket-type extractor

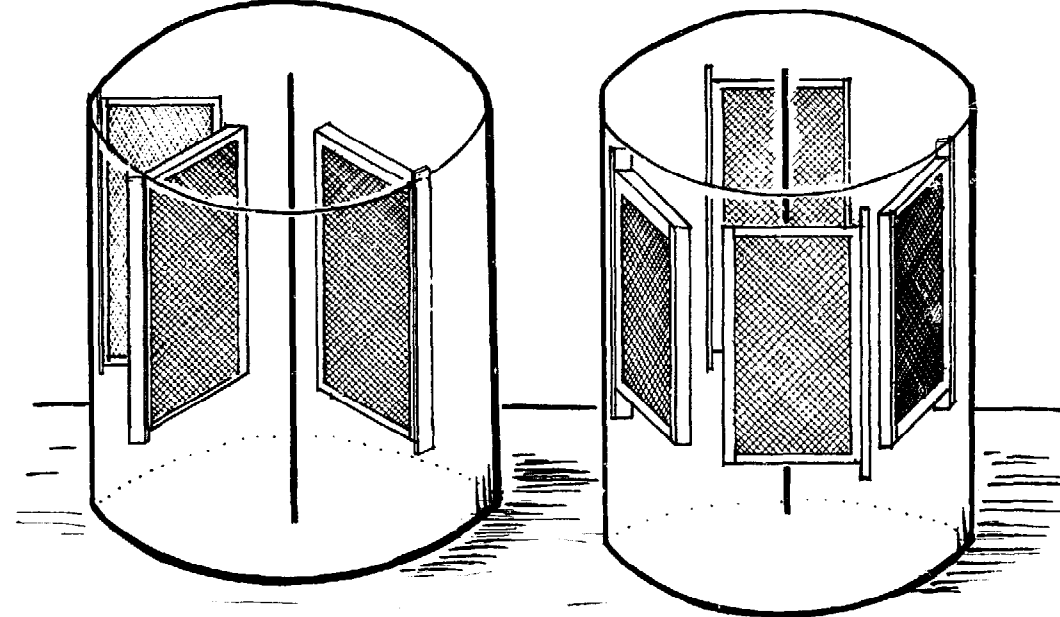

Uncapping Setup

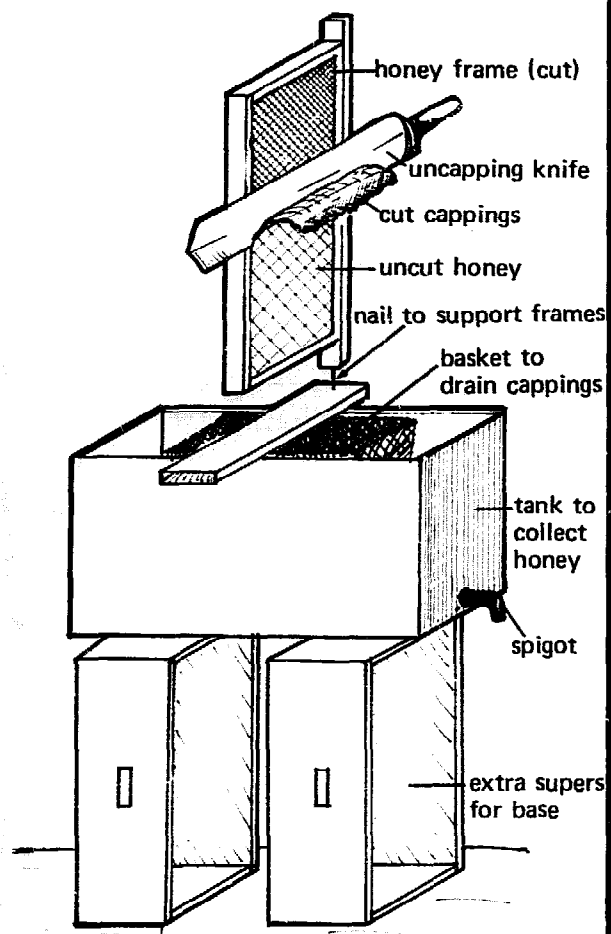

Cooking With Honey

Honey is a truly natural sweetener, and it is often used to replace sugar in cooking. Since honey is a combination of sugars that are broken down by the bees into the simple sugars of levulose and dextrose, it is very digestible, especially to infants and the infirm. Some claims about the benefits of honey, whether exaggerated or not, maintain that honey is helpful in:

- retaining calcium in the body
- counteracting the effects of alcohol in the blood
- deterring bacterial growth
- providing quick energy
- keeping baked goods moist

When substituting honey for sugar in any basic recipe, the following rules should be observed:

- Reduce the liquid in the recipe by 1/4 cup for each cup of honey used to replace sugar.
- Measure honey with a greased utensil.
- Use a mild-flavored honey, unless the flavor of the honey is a necessary part of the product.
- Some people add 1/12 to 1/5 teaspoon of baking soda per cup of honey to counter the honey's acid.
- Reduce the cooking temperature by 25°.

If honey is stored in a dry place (not the refrigerator) or if it is frozen, it will granulate (crystallize) much more slowly and will not ferment. To liquify granulated honey, place the container in a pan of warm water until the crystals are melted; do not let the honey overheat, as many of the flavors and aromas of honey are volatile and are destroyed by heat (see *REFERENCES: Honey and Honey Cook Books*).

BEESWAX

The domestic wax industries are only able to obtain half of the beeswax they need from U.S. beekeepers; the other half is imported. Because wax foundation is expensive beekeepers should make every effort to save all cappings, old combs, and bits and pieces of extra wax scraped from frames and other hive parts and to melt these down to trade for wax foundation.

Cappings, old combs, and wax scrapings should be kept in airtight containers or frozen until melted down to prevent infestation by wax moths. Cappings should be melted separately from the old combs, since the latter contain nonwax substances which would impregnate and reduce the value of the almost pure wax cappings. Use extreme caution when melting wax: wax ignites easily and wax fires are difficult to put out.

Melting

Wax cappings, old combs, and scrapings can be melted with one of these devices:

- electric wax melter
- solar wax melter
- double-boiler (use aluminum or stainless steel container; other containers such as iron or copper will darken the wax)

An often-used method is to place the old comb and scraps in a burlap bag; submerge the bag in a tub or barrel of water (stones or bricks placed in the bag

will help keep it submerged). Heat the water to 190°F (88°C) for several hours, occasionally poking the bag with a stick to allow the wax to move through the fabric to the surface of the water. After the wax has melted, remove the heat and allow the water to cool; the wax will solidify on the surface of the water.

None of these methods will be sufficient to render all the wax found in old combs; the wax that remains should not be discarded but saved and brought to a dealer who has the special equipment which is capable of rendering it.

Solar Wax Melter

The solar wax melter is essentially a box painted black inside and out, covered with a piece of glass, plexiglass, or plastic, and made airtight. It is put in a sunny location, tilted at right angle to the sun's rays. The sun heats the interior of the box, something like a greenhouse, melting the wax inside which collects into a pan. For greater heating efficiency, some beekeepers use two pieces of glass or plexiglass, with a 1/4 inch (6.23 mm) gap, for better insulation. The inside of the box contains a metal tray, fashioned from sheet metal, onto which the wax comb and scraps are placed (see illus.).

The melter will melt cappings, new burr comb, and old comb, but it will not melt the old comb completely. After this older comb has been in the melter for a few days, collect the black, gummy remains and take them to a bee supply dealer to be rendered down more

completely. The amount of wax one can derive from broken pieces of foundation, cappings, and old or burr comb is extensive and well worth the effort.

Solar Wax Melter

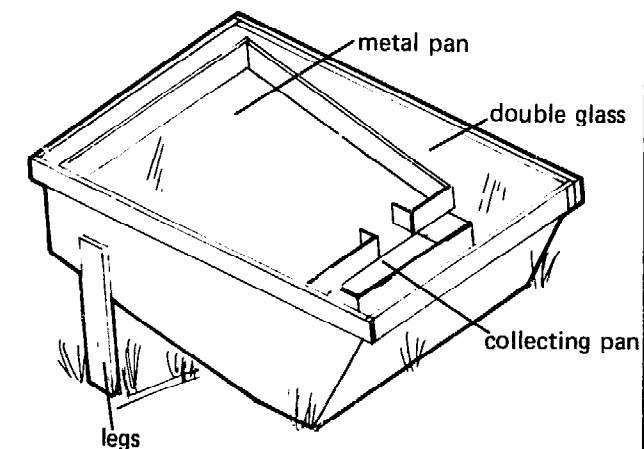

BEE BROOD

Bee brood, at the present time, is generally an unexploited product of the hive. Like most organisms, bee brood is rich in proteins and other substances required in our daily diet. The value of this hive product does not yet compensate the cost of removing brood from comb and the reduction of the adult colony population that ensues if too much brood is removed. Honey bee brood is currently used, on a small scale, as food for birds, reptiles, and fish. Drone larvae is often used for fish bait.

BEE VENOM

Bees require pollen in their diets in order to synthesize some of the components of venom. The synthesized venom is stored in the poison sac of worker and queen bees (see *APPENDIX: Anatomy of the Honey Bee*). Venom contains a complex array of chemical substances, like histamine, which reacts adversely with the body chemistry of some individuals.

In order to collect substantial amounts of venom, either for medical use or other scientific work, a special electrical grid is placed near the entrance of a hive. This grid produces a mild shock and bees that land on it react by stinging a sheet of nylon taffeta below this grid. The venom is deposited on and collected from a glass plate located below the nylon portion of the device.

Research is still in progress concerning the benefits obtained from honey bee venom for persons with rheumatoid arthritis and other diseases. In addition, recent research indicates that some of the components of venom are much more effective than other serums in desensitizing persons who are allergic to bee venom.

See *APPENDIX: Physiology of Bee Sting Reaction* and *REFERENCES: Products of the Hive (Excluding Honey)*.

ROYAL JELLY

Royal jelly, the milky-white secretion from the food glands of the workers used to feed young larvae, is sometimes collected and sold. It is rich in proteins and B-vitamins, and its acidic properties combat fungus and bacteria. The Chinese have long used it for its dietary and cosmetic value.

PROPOLIS

From the Greek words *pro* (before) and *polis* (city), propolis is a resinous substance collected and used by bees to seal up the hive and reduce the entrance (in front or *before* the city) for winter protection and defense. It comes from the sticky exudations of trees and buds—such as the alders, poplars, and some conifers—and is collected by foragers and transported back to the hive on the pollen-collecting structures.

Although propolis is a sticky, gummy mess in the hive, recent discoveries,

especially in Russia, have shown that this product can be quite valuable. Its antimicrobial action has been found effective against infection in farm animals (see *REFERENCES: Products of the Hive, Excluding Honey*). Since propolis is not water-soluble, use acetone or ethyl alcohol to remove it from hands and clothing.

POLLEN

Pollen, the protein-rich powder produced by the male parts of flowers, is collected and sold by beekeepers to health food stores, to pollination businesses, to bee dealers (for bee food), and to allergy victims (as a desensitizing agent). Pollen traps are put on hives to collect pollen pellets from foraging bees. Pellets so collected should be stored properly (see *FEEDING BEES: Pollen* and *REFERENCES: Products of the Hive [Excluding Honey]* and *Feeding Bees*).

Bee Pests and Diseases

ANIMAL PESTS

Skunks

Skunks often visit hives in the evening and, by scratching at the entrance, entice bees to come out of the hive. As the bees crawl out, the skunk eats them. Colonies can become greatly reduced in size if they receive continuous visits from skunks.

Signs of skunk visits are:

- aggressive bees
- grass near hive entrance torn up
- weak colony
- area near entrance muddy after a rain

Discouraging and eliminating skunks may be accomplished by:

- sprinkling salt or lye crystals on the ground around the hive
- trapping skunks
- killing skunks in their lairs
- using poison baits (this method is not advocated since it is not selective enough and can harm other organisms)
- using hive stands to keep bees out of reach (see *BEFORE THE BEES ARRIVE: Hive Stands*)
- extending a piece of hardware cloth

in front of the entrance which will allow bees to sting the skunk's belly

Before killing or baiting poison traps, contact state game and wildlife departments and comply with regulations for controlling fur-bearers.

Bears

Bears eat brood and honey and do extensive damage to equipment, especially in the western and northern states where large bear populations exist. Bears are capable of destroying apiaries.

Signs of bear damage are:

- overturned hives
- smashed hive bodies
- frames scattered over the apiary

An electric fence around the apiary is probably the only effective control against bears, although this form of protection, in most cases, is often too costly. Alternatives include:

- moving bees to a new location
- seeking the assistance of local conservation departments

Mice

Mice enter hives in the fall and winter and, although they appear not to harm the bees, can cause some comb damage.

Signs of mice damage are:

- chewed combs or wood
- nesting materials (grass, paper, straw, or cloth or such) in hive usually among the comb

The following measures may help

to control damage from mice:

- Place hives on stands (although mice can climb).
- In fall, close the entrance with 4-mesh hardware cloth or metal mouse guards.
- Use entrance reducers.
- Place poison grain on bottom boards (not recommended since its effect is not selective).

Vandals

There has been an increase in the number of hives stolen or otherwise vandalized in recent years. The increasing demands for equipment, honey, bees, and hives for pollination services have all contributed to the prevalence of thieves. Furthermore, colonies are also vandalized by the curious who think that by simply opening up a colony they will be able to obtain some free honey. In addition, those bent on mischief can overturn or otherwise damage hives.

Vandals can be discouraged by placing apiaries near year-round dwellings. If it is not possible to place them near one's own residence, land can often be rented from a homeowner with available land for a few pounds of honey a year. Branding your hive bodies and frames is also good protection. If your hives are stolen, for example, and the bee inspector finds your brand on hives in some other yard, the person responsible for the act is more likely to be apprehended and your equipment returned to you.

BIRD PESTS

Although many birds are insectivorous, few if any eat bees in large quantities. Flycatchers and king birds have been reported to feed on bees, and woodpeckers can damage old abandoned hives. However, the beekeeper should make no attempt to control birds by poisoning, shooting, or such; shooting or poisoning many birds is also illegal.

POISONOUS PLANTS

Sundew, Venus Fly Trap, and Pitcher Plants are insect-eating plants that attract insects by secreting a sweet sap and/or odor. These plants grow in wet areas and are not usually attractive to bees; the number of bees lost to them is minimal. The following plants, as reported by J. F. Morton ("Honeybee Plants of South Florida," see *REFERENCES: Honey Plants*) and by E. L. Atkins in Chapter XXII in the *Hive and the Honeybee*, ed. by Dadant and Sons, Inc. 1975), yield nectar or pollen toxic to bees:

- Azaleas and Rhododendrons (*Rhododendron* spp.)
- Black Nightshade (*Solanum nigrum*)
- California Buckeye (*Aesculus californica*)
- Death Camas (*Zygadenus venenosus* Wats.)
- Dodder (*Cuscuta* spp.)
- Eastern Mt. Laurel (*Kalmia latifolia*)

- Locoweeds (*Astragalus* spp.)
- Seaside Arrowgrass (*Triglochin maritima*)
- Summer Titi (*Cyrilla racemiflora* L.)
- Western False Hellebore (*Veratrum californicum*)
- Whorled Milkweed (*Asclepias subverticillata*)

Notes

MAJOR INSECT ENEMIES

Acarine Disease

Acarine disease is not present in the United States, but it is widespread in Europe where it affects adult bees. This disease is actually caused by a small mite (*Acarapis woodi*) as a result of the female mites laying their eggs in the thoracic tracheae (breathing organs) of adult bees. After the eggs hatch, the immature mites live as parasites inside the breathing organs of the adult bees and will cause severe bee losses, sometimes weakening or destroying entire colonies.

In 1922 the U.S. Government passed the Honey Bee Act which prohibits importation of adult bees into the U.S. from abroad. This legislation was enacted to prevent the introduction of these mites into the U.S.

Wax Moth

The female Greater Wax Moth (*Galleria melonella*) is about 3/4 inch long, gray-brown (color varies somewhat), and holds her wings tent-like over her body. This moth deposits eggs in cracks between hive parts or in any other suitable place inside the hive. After hatching, the larvae tunnel into the wax combs. The dark wax of brood combs contains the shed exoskeletons of bee larvae and some pollen, both of which are eaten by the wax moth larvae. As these larvae tunnel along, silk strands mark their trails through the combs. Before pupating, the larvae fasten themselves to the frames, inside walls, inner covers, or bottom boards of the hive and spin a silk cocoon, sometimes damaging the hive by chewing the wooden parts just before spinning their cocoons. Left untended, wax moths can destroy weak hives within one season.

Symptoms of wax moth damage are:

- tunnels in combs
- silk trails, crisscrossing one another over combs
- small dark objects (excrement of wax moth larvae) in the silk trails in a hive
- silk cocoons attached to wooden parts
- destroyed comb, piles of debris on bottom board

To control wax moths, use these methods:

- Maintain strong colonies (the best defense against wax moths).
- Store empty combs in cold places since freezing temperatures kill the larvae.
- Freeze comb honey.
- Store empty combs with moth crystals.

Some chemicals can be used to fumigate combs, but their permitted use varies from state to state. The state bee inspector or extension entomologist should be consulted before using chemicals.

The Lesser Wax Moth does similar damage to wax comb, but unless the infestation is great, the damage is minor compared to that of the Greater Wax Moth.

MINOR INSECT ENEMIES

Although bees are often preyed on by other insects and spiders, these predators usually do not have any appreciable effect on a colony's well-being. Some insects that do eat adult bees include:

- Ambush bugs (Hemiptera: *Phymatidae*)
- Robber flies (Diptera: *Asilidae*)
- Mantids (Orthoptera: *Mantidae*)
- Hornets and Wasps (Hymenoptera: *Vespidae*)
- Dragonflies (Odonata: *Anisoptera*)

Spiders (*Araneida*) also prey on adult bees—some species even wait for them to arrive at a flower before attacking. The most common types of spiders that would catch a bee are the orbweaving, grass, and house spiders.

Ants, earwigs, and cockroaches may use various hive parts, especially the inner cover, as a shelter or nest. While not a serious problem in the temperate climates, in the tropics hives have to be placed on top of greased or oiled cans or on posts to keep out marauding ants.

Other pests that find their meals in a hive are:

- Bee louse (Diptera: *Braculacaeca*), eating food out of the bee's mouth
- Earwigs (Dermaptera)
- Weevils (Coleoptera: *Curculionidae*)
- Beetles (Coleoptera)
- Pollen mite (*Acari*)

To control these insect pests, store equipment in cold or freezing temperatures. *Never* use insecticides or pest strips, since these will also kill bees.

ADULT BEE DISEASE

Nosema Disease

Nosema is the most common adult bee disease. It is the most prevalent in the spring, especially after winter weather has confined bees to their hive. Nosema greatly reduces adult bee populations, and it is a factor in the supersedure of package bee queens, further delaying the growth of a hive in which packages are installed.

Some symptoms of the disease, listed below, are also associated with pesticide poisoning, but if most of these are observed in the spring, nosema should be suspected:

- bees cannot fly or can fly only short distances
- bees seen trembling and quivering, colony appears restless
- feces on combs, bottom boards, and outside walls of hive
- bees seen crawling aimlessly on bottom board, near entrance, or on ground; some dragging along as if their legs were paralyzed
- wings positioned at various angles from body—not folded in normal position over abdomen
- abdomen distended (swollen)
- when bee is dissected, mid-gut (ventriculus) is swollen, dull, grayish-white color and circular constrictions of gut (similar to constrictions on an earthworm's body) are no longer evident; normal gut color is brownish-red or yellowish,

with many circular constrictions (see illus.)

For positive diagnosis of nosema, tease apart some bee guts and place them under a microscope; spores will be evident.

Treatment for Nosema

Good management practices and the feeding of Fumidil-B as a preventative measure help insure healthy colonies (see *ADULT BEE DISEASE: Chemotherapy*).

To prevent or control the disease from spreading the beekeeper should also:

- provide fresh, clean water
- provide young queen
- locate hives at sunny sites, sheltered from piercing winds but with good air drainage
- maintain adequate stores of pollen, honey, or cured sugar syrup; if stores are short, bees should be fed a heavy medicated syrup in early fall
- keep only clean combs; sterilize or dispose of those that are soiled with fecal material or are diseased
- provide upper hive entrance for the winter

Combs with nosema spores can be sterilized if heated to 120°F (49°C) for 24 hours; combs should be free of honey and pollen and temperature should not get above 120°F or wax will melt.

Diseased combs can also be fumigated in a well-ventilated place:

- Place a hive body on a board or upturned outer cover.
- Soak a pad of cotton or wad of

rags in 1/4 pint 80 percent acetic acid (available from photo supply houses); place pad on top bars of combs.

- Add hive bodies above first, placing soaked pad above the top bars of each hive body in the stack.
- Make the stack airtight by sealing adjacent hive bodies with masking tape and cover the top with a board.
- One week later, disassemble the stack and air out combs for two days.

Dysentery

Dysentery is not caused by a micro-organism and is not a disease at all, but is primarily the result of poor food and long periods of confinement. In general, dysentery is caused by:

- fermented stores
- diluted syrup fed in fall
- syrup with impurities such as raw or brown sugar
- dampness
- long periods of confinement
- too much moisture in the air
- poor drainage
- honeydew in stores

The symptoms of dysentery are:

- languid bees
- swollen abdomens
- hive stained with yellow to brownish fecal material

To treat dysentery:

- provide winter exit so bees can take cleansing flight on warm winter days

Effects of Nosema Disease on Midgut

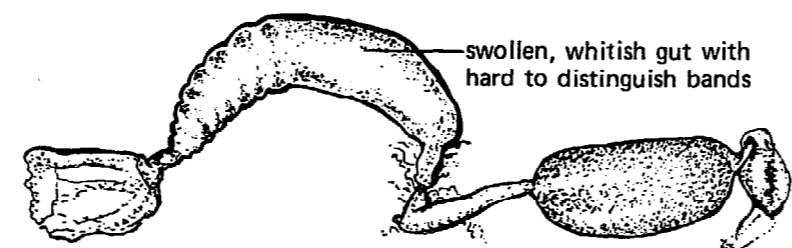
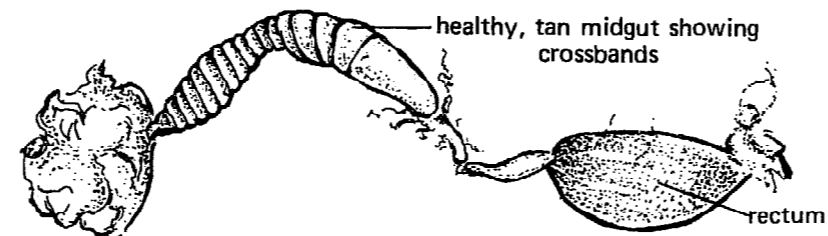

Nosema Spores

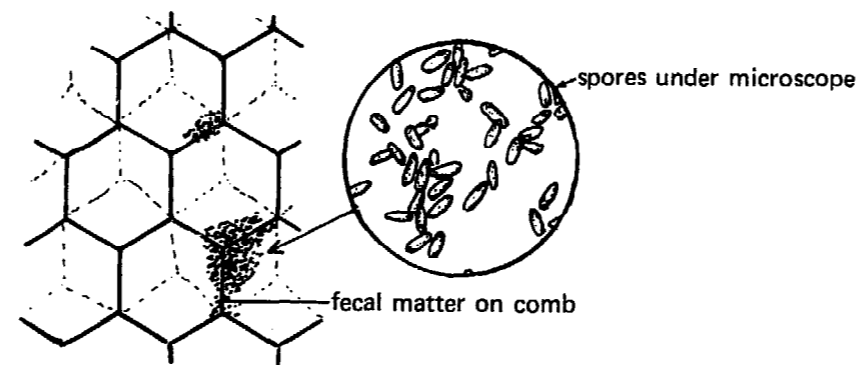

- provide good stores, with low water concentration (properly cured honey and sugar syrup)
- feed thick syrup in fall if bees need more stores
- medicate as for nosema as a preventative measure

Septicemia

The cause of septicemia is a bacteria found in the blood of bees, called *Pseudomonas aspiseptica*. It rarely if ever debilitates bee colonies and can be recognized by these symptoms:

- dying bees are sluggish
- dead bees decay rapidly
- dead bees become dismembered when touched
- dead bees have putrid odor

The disease is transmitted by soil, water, and infected bees by way of their breathing organs (tracheae). To treat this disease, place hives in locations that are sunny and dry and that have good air drainage.

Pesticide Poisoning

Bees are vulnerable to many of the insecticides used by orchardists, farmers, and other growers to control harmful insect pests. This problem will continue to be serious if the amount of insecticides used continues to increase.

Signs of bee poisoning are evident by the sudden decrease in the foraging force of a hive due to their destruction in a sprayed field. Look for:

- weakened hives, low honey production

- disorganized hive routine (to make up for bee loss)
- masses of dead bees, those that made it back, at hive entrance
- brood killed by contaminated pollen stores; hive may appear to have a brood disease
- adult bees killed by contaminated water in puddles by the fields sprayed with insecticides; bees will collect contaminated water on hot days and die at the hive entrance
- aggressive hives

The types of insecticides generally used in this country are:

- organophosphates
- chlorinated hydrocarbons
- carbamates
- dinitrophenyl
- botanicals
- pathogens

The following symptoms summarize the information given by E. L. Atkins in the *Hive and the Honey Bee*, edited by Dadant and Sons, Inc., Hamilton, Illinois, 1975.

Organophosphate poisoning is recognized by these symptoms:

- wet bees, regurgitating
- disoriented, awkward movements
- lazy, semi-paralyzed appearance
- erratic cleaning attempts
- wings hooked but held away from the body
- high percentage of dead bees at colony entrance

The most toxic of this class of insecticides are:

- Fenthion (Baytex) (and Ethyl Parathion)
- Diazinon
- Dursban
- Dimethoate
- EPN
- Ethyl Guthion (Azinphos-ethyl)
- Fensulfothion (Dasanit)
- Guthion (Azinphos-methyl)
- Malathion
- Methyl Parathion
- Penncap-M
- Trithion
- Phosdrin (Mevinphos)
- Phosphamidon (Dimecron)
- Sumithion
- Supracide
- Systox (Demeton)
- Tepp
- Vapona (Dichlorous; DDVP)

Chlorinated Hydrocarbon poisoning is recognized by:

- spasmodic movements
- semi-paralyzed appearance
- wings held away from body
- high percentage die in the field as well as in the hive

The most toxic insecticides in this class are:

- Lindane
- Chlordane (only the stock formulated prior to July 25, 1975)

Carbamate poisoning is recognized by:

- aggressive attitude of bees
- spasmodic movements
- stupefied, paralyzed attitude
- high percentage die at hive
- queen ceases to lay, supersedure attempted

The most toxic insecticides in this class are:

- propoxur (Baygon)
- Banol
- carbaryl (Sevin)
- carbofuran (Furadan)
- metacil
- methomyl (lannate and Nudrin)

Dinitrophenyl poisoning is recognized by:

- regurgitation of the digestive tract contents, as in organophosphate poisoning
 - high percentage of bees die at hive
- The most toxic to bees in this class

is:

- dinoseb (dinitrobutylphenol)

Botanical poisoning is recognized by:

- regurgitation of digestive tract contents
- spasmodic movements
- paralysis
- bees die quickly between hive and field since botanical kills on contact but does not last long in the environment

The most toxic insecticides in this class are:

- the pyrethroids

Other insecticides include the inorganic materials and have to be ingested by the bee (as in a syrup or water) to be poisonous. These are:

- calcium arsenate
- cryolite
- lead arsenate

Pathogen insecticides, unless specific for hymenopterous insects, are not toxic to bees. Some pathogens used to control many lepidopteran insects (like the Wax Moth or Gypsy Moth) are:

- Bacteria: *Bacillus thuringiensis* (Dipel, Biotrol, Thuricide)
- Virus: *Trichoplusia polyhedrosis* (Polyhedrosis Virus)

Protecting Bees from Pesticides

Since insecticide poisoning is a serious problem in some areas, this section gives some guidelines to help protect your bees from destruction by poisoning:

- Time of spraying:* Do not spray when bees are actively flying.
- Never spray plants in bloom nor let spray drift to blooms.
- Field conditions:* Spray during cold, inclement days, or at night if below 70°F (21.1°C).
- Dosage:* Always use proper dosage; if possible use materials less toxic to bees.
- Type of application:* If spray is a dust, try to prevent drifting of dust toward hives; coarse sprays or granular materials are less hazardous; use insecticides more specific to pest, not the wide-spectrum chemicals that kill everything.
- Familiarization:* Notify grower/applicator of proximity of hives and request to be notified before any spraying begins.
- Moving hives:* Covering hives with burlap or plastic and closing en-

trance with screen may be a way to protect bees; keep burlap wet. If bees are covered for more than a few days there is the danger they will be smothered. Move hives out of area and move back into the area only when the potency of the particular insecticide is rendered innocuous.

Federal Indemnity Programs, developed to reimburse beekeepers due to pesticide losses, are available through local state agencies, cooperative extension offices, or agricultural stabilization agencies.

BROOD DISEASES

Chalkbrood

Although common in Europe for decades, chalkbrood was first reported in the United States in 1968 and has since spread throughout the country. It is caused by a fungus *Ascospaera apis* (Maassen ex. Clausen) and may reduce honey production but usually will not destroy a hive. The symptoms are white, mummified larvae which are easily removed from their cells. The larvae are most susceptible to disease when four days of age.

This fungus is transmitted by:

- wind
- soil
- nectar, pollen, and water
- drifting
- diseased robber bees
- the queen

Treatment of hives with chalkbrood includes:

- moving hive to sunny location
- removing infected combs
- adding bees to strengthen weakened, diseased hive
- requeening if disease is severe (See *REFERENCES: Diseases.*)

European Foulbrood (EFB)

European foulbrood is caused by a spore-forming bacteria *Streptococcus pluton*, although other bacteria may also infect larvae at the same time. It is commonly found in weak hives. The disease slows the growth of the colony and is usually prevalent in the spring. Not as serious as American foulbrood (AFB), EFB should be treated with drugs and the colony should be requeened and/or strengthened with additional bees.

The *symptoms* of a hive infected with EFB are:

- larvae die in a coiled or irregular position in their cells
- since most larvae die young, their cells are not capped
- larvae color may change from light cream to grayish brown, darkening as the dead larvae dry up (normal color is pearly white)
- dry scales (the remainder of the larvae) are easily removed from their cells, unlike AFB scales which are difficult to remove
- some larvae die in capped cells, scattered over the brood comb; cappings may be discolored,

- concave, and punctured
- an odor may be present
- dead larvae are normally not ropery as in American foulbrood
- drones and queen larvae are also affected

EFB is *transmitted* from hive to hive in these ways:

- cells in which larvae hatch may contain bacteria
- bacteria are present in honey and/or pollen and are passed on to larvae by nurse bees feeding them
- as scales are removed by cleaning bees, bacteria are spread throughout the hive
- diseased robber bees enter the hive
- contaminated equipment
- drifting of bees from diseased hives

To control EFB:

- requeen
- use chemotherapeutic agents (see *Brood Disease Chemotherapy*)

American Foulbrood (AFB)

American foulbrood disease (AFB) is caused by a bacteria *Bacillus larvae*, which exists in both a spore and vegetative stage. The disease is transmitted by the spore and the infected brood is killed by the vegetative stage. This is the most destructive of the brood diseases. Once the vegetative stages appear in a colony, the disease spreads rapidly and the colony weakens; in most cases the hive will eventually die.

The *symptoms* of AFB are:

- brood pattern is irregular rather than compact
- healthy larvae are glistening white color; diseased ones lose this appearance, and turn from light brown to dark brown
- dead larvae develop a consistency of glue and are difficult for bees to remove
- the death of larvae and pupae often occurs after their cells are capped; such cappings become concave and some will be punctured by bees attempting to remove the dead brood (see illus.)
- surface of cappings will be moist or wet rather than dry
- eventually dead larvae dry out; the dried out remains or scales adhere to the bottom, back, and side walls of the cell and are difficult to remove
- some dead pupae, shrunken into scales, have their tongues protruding at a right angle to their scale
- unpleasant odor

AFB is transmitted from hive to hive in these ways:

- cells in which larvae hatch may contain bacteria
- bacteria are present in honey and/or pollen and are passed on to larvae by nurse bees feeding them
- cleaning bees spread bacteria throughout hive when attempting to remove dead brood
- diseased robber bees enter the hive or bees rob from diseased hive
- contaminated equipment
- drifting bees from diseased hives
- swarms
- wax combs containing spores

If a colony is suspected of being diseased with AFB, follow these steps:

- Reduce entrance to minimize robbing.
- Distinguish it from the rest by color or symbol to reduce drifting.
- Begin medication (chemotherapeutic) program.
- Call state bee inspector for advice and to confirm diagnosis or, to confirm diagnosis, send a sample of brood comb which is free of honey, about 4 or 5 inches square, and contains as much of the diseased brood as possible.

Cut sample out of the frame and wrap it in newspaper so it will not get moldy; do not use any other kinds of wrapping. Place it in a sturdy wooden or cardboard box and mail to your state bee lab or to one of the national bee labs operated by USDA (see *REFERENCES: USDA Bee Labs*).

Testing for AFB. Use the "ropey test," described below, on larvae that have been dead for about three weeks. Since it is difficult to determine how long a larva has been dead, randomly test five or more. An accurate way of determining how long a larva has been dead is by checking the presence or absence of its body segments or constrictions (like earthworm constrictions). If absent, the larva has been dead for at least three weeks.

Insert a match, stem, or twig into a cell, stir the dead material, then slowly withdraw the testing stick. If a portion of the decaying larvae clings to the twig and can be drawn out about 1 inch (2.5 cm) or more while adhering to the other end (the dead larva), its death was probably due to AFB. **BE SURE TO BURN THE TEST STICK.**

Treatment of Hives. Before the availability of chemotherapy and ethylene oxide gas chambers, the only acceptable method of dealing with colonies infected with AFB was to destroy them by burning. Three methods of treating diseased hives, other than medication, are discussed here:

Burning:

- Kill all adult bees with Resmethrin or other poison.
- Burn bees and frames in a deep pit.
- Cover with dirt.
- Invert and stack hive bodies.
- Pour kerosene inside stack and ignite it; when insides of hive bodies are scorched, extinguish fire. (A propane torch can also be used; wood should be lightly browned.)
- Also scorch inner and outer covers and bottom boards.

Exchanging Hives:

- Exchange diseased hive with a cleaned hive full of foundation.
- Shake adult bees from diseased hive into one with foundation; these bees must not drift to other colonies. Place new hive on newspapers to catch honey which may drop while shaking and then burn the newspaper. Shake the bees in the evening, using extreme caution to prevent drifting. If necessary, screen entrances or move adjacent colonies away before shaking diseased hive.
- Feed medicated syrup to bees now on foundation.
- Burn diseased hive as explained above.

Fumigation: After killing bees or placing them on foundation (see above),

Appearance of Capped Brood Cells with AFB

sunken, punctured
cappings

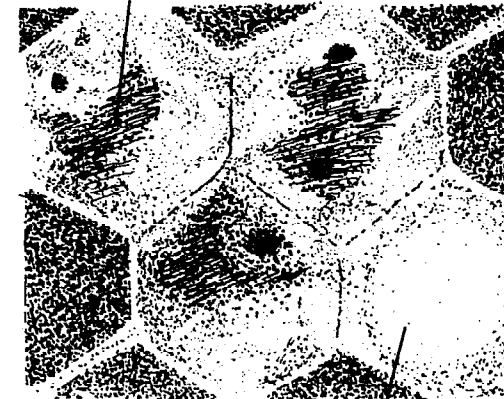

normal convex
capping

Ropey Test for AFB

sunken capping,
punctured by bees



larval remains

pupal tongue

place hive bodies, covers, and bottom boards in an ethylene oxide gas chamber. This method kills the disease spores and allows the equipment to be re-used.

Before burning, exchanging, or using chemotherapy on bees with AFB, check with your state's bee inspector to be sure the procedure is legal and to determine the amount and kind of medication that is permissible. If you intend to kill the bees, inquire from the inspector as to the poison you should use and the availability of an ethylene oxide chamber.

BROOD DISEASE CHEMOTHERAPY

Drugs can be given to bees for both AFB and EFB once the disease has been diagnosed or as a preventative measure. The two drugs *sodium sulfathiazole* (sulfa) and *terramycin* (TM) are used and mixed with syrup, dry sugar, or in a patty. Drugs used as a preventative measure should be applied in the spring and fall, not during a honeyflow. If drugs are used during a honeyflow, the honey must not be used for human consumption.

Here are some formulas:

Sodium Sulfathiazole (from bee supply houses):

—in syrup

mix 1/4 teaspoon per gallon of a 1:1 or a 2:1 (sugar:water) syrup

—dry

mix 3 tablespoons of sulfa with a 1 pound bag of confectioner's sugar or with granulated sugar; then dust 2 tablespoons of mixture on top bars of brood frames

Terramycin (Animal Formula Soluble Powder from farm and bee supply stores):

—in syrup (TM loses viability in syrup after one week)

mix 2 teaspoons of TM-25 per gallon of 2:1 or 1:1 syrup

Or,

mix 1 teaspoon of TM-50 per gallon in 2:1 or 1:1 syrup

—dry

mix 2 tablespoons TM-25 in 20 tablespoons sugar

Or,

mix 1 tablespoon TM-50 in 20 tablespoons sugar

Then, dust 4 tablespoons of either above mixture on ends of top bars and/or bottom board; do not dust directly on top of brood frames containing uncapped larvae since TM is toxic to them

—patty

mix 1/4 pound confectioner's (powdered) sugar with—

1 tablespoon TM-25 or 1 teaspoon TM-50

1/4 pound shortening

blend together and roll into a 1/4 inch thick patty; place on top bars as if feeding pollen patties

ADULT BEE DISEASE CHEMOTHERAPY

The drug used to control nosema disease is Fumidil-B, sold at bee supply houses. It is fed in this formula:

—syrup

1 teaspoon per gallon of 2:1

(sugar:water) syrup

Or, for six packages:

0.5 grams per 6 gallons of 2:1 syrup

NOTE:

—proper dosage, especially for bees confined for long periods of time, is 2 gallons medicated syrup per hive

—one gallon of 2:1 syrup equals 7 3/4 pounds of sugar and 1/2 gallon of water

—one gallon of 1:1 syrup equals 4 pounds sugar and 1/2 gallon water

Bee Plants

POLLINATION

Fertilization takes place when the pollen, or male sex cells, of a flower unite in the ovary of the female sex cells. This transfer of pollen from the male sex organs (see illus.) is called pollination.

All plants must be pollinated before seed (or fruit) will set. Pollen is transferred from the anthers to the stigma of a flower by wind, water, gravity, mammals, birds, humans, and insects.

The most efficient pollinators—since they are highly motile, small, and plentiful—are the insects. Major insect pollinators include beetles, flies, butterflies, moths, and bees. Bees are probably the principal pollinating agents of plants whose flowers have colors within a bee's visual range—blue, yellow, green, and ultraviolet. Bees are effective in pollinating flowers, such as commercial fruit crops, which are self-infertile, that is, which require pollen of another type or variety to set seed. They are one of the most efficient pollinating agents since they can be manipulated by man. About eight billion dollars worth of crops are pollinated by bees in the U.S.

HONEYDEW

In addition to nectar collected from floral or extra-floral nectaries, bees collect another sugary liquid called honeydew. Honeydew may be secreted directly by a plant or may be excreted from the intestinal tract of aphids and scale insects as they feed on plant sap. Bees will sometimes collect honeydew in large quantities and store it as honeydew honey, which is dark in color, contains less of the two principal sugars found in honey, and has a higher pH (lower acidity) than honey made from nectar.

HONEY AND POLLEN PLANTS

Beekeepers wishing to improve their yields may consult honey plant lists (see *REFERENCES: Honey Plants and Nurseries and Plant Catalogs*) and collect or purchase seeds, plants, or cuttings of species with high-yielding honey value. Many of the plants richest in nectar and pollen grow wild and have no commercial value; some are considered weeds. However, weeds detrimental to agriculture should not be encouraged where valuable farm land will be invaded.

LEASING BEES

Many beekeepers lease their hives to fruit and vegetable growers whose crops must often be pollinated by bees.

The need for bee pollination is increasing due in part to declining bee populations caused by urbanization of natural foraging land, pesticide use, and pollution.

Some factors to consider when leasing or renting bees are:

- Number of hives:* if other factors are favorable, count on one colony per acre of fruit crops, more for other crops.
- Weather:* optimum flying conditions for bees include temperatures between 60° and 90° F (15.6° to 32.2° C), winds of less than 15 mph, and fair, sunny days.
- Colony strength:* each colony should have at least five brood frames and a laying queen.
- Timing:* set out bees just as crop comes into bloom; if set out too early, bees may set up their own flight patterns.
- Leasing fees:* although there is no flat fee for leasing bees, some factors that may affect the price include pesticide hazard; loss of queen, bees, and/or honey; and the difficulty of getting to and from the field.

**COMMERCIAL CROPS
REQUIRING OR BENEFITING FROM
BEE POLLINATORS**

The USDA maintains a list of commercial crops in a publication entitled *Insect Pollination of Cultivated Plants* by S. E. McGregor (Agricultural Handbook #496, 1976). It includes these commercial plants:

Legume and Seed Crops (Pasturage)

- Alfalfa (lucerne)
- Clovers:
 - Annual White Sweetclover
 - Annual Yellow Seetclover
- Alsike
- Crimson
- Ladino
- Red
- White Dutch
- Field and Broad Beans
- Bush or Lespedeza Clover
- Lima Beans
- Sainfoin
- Trefoil
- Vetch

Crucifera: Rape

Others:

- Sugar Beets
- Buckwheat
- Flax
- Linseed
- Safflower
- Sunflower
- Soybeans
- Cotton
- All Culinary Herbs

Vegetable Crops: Liliaceae

- Asparagus
- Chives
- Garlic
- Leek
- Onion

Malvaceae:

- Okra

Crucifera:

- Broccoli
- Brussel Sprouts
- Cabbage
- Chinese Cabbage
- Collard
- Horseradish
- Kale
- Kohlrabi
- Mustard
- Radish
- Rutabaga
- Turnip

Curcubiaceae:

- Cantaloupe (Muskmelon)
- Cucumber
- Gourd
- Pumpkin
- Squash
- Watermelon

Solanaceae:

- Eggplant
- Pepper
- Tomato

Umbelliferae:

- Carrot
- Celery
- Parsley
- Parsnip

Other Vegetables:

- Sweet Potato
- Lettuce
- Beets
- Rhubarb

Fruits, Nuts and Berries

- Almond
- Apple
- Apricot
- Artichoke
- Avocado
- Blackberry
- Blackcurrent
- Blueberry
- Cherry
- Citrus Fruits:
 - Grapefruit
 - Lemon and Lime
 - Orange
 - Tangelo
 - Tangerine
 - Temple Orange
- Cranberry
- Chestnut
- Date Palm
- Dewberry
- Fig
- Gooseberry
- Grape
- Huckleberry
- Olive
- Peanut
- Peach
- Pear
- Plum (Prune)
- Persimmon
- Raspberry

- Redcurrent
- Strawberry
- Tung

Flower Parts

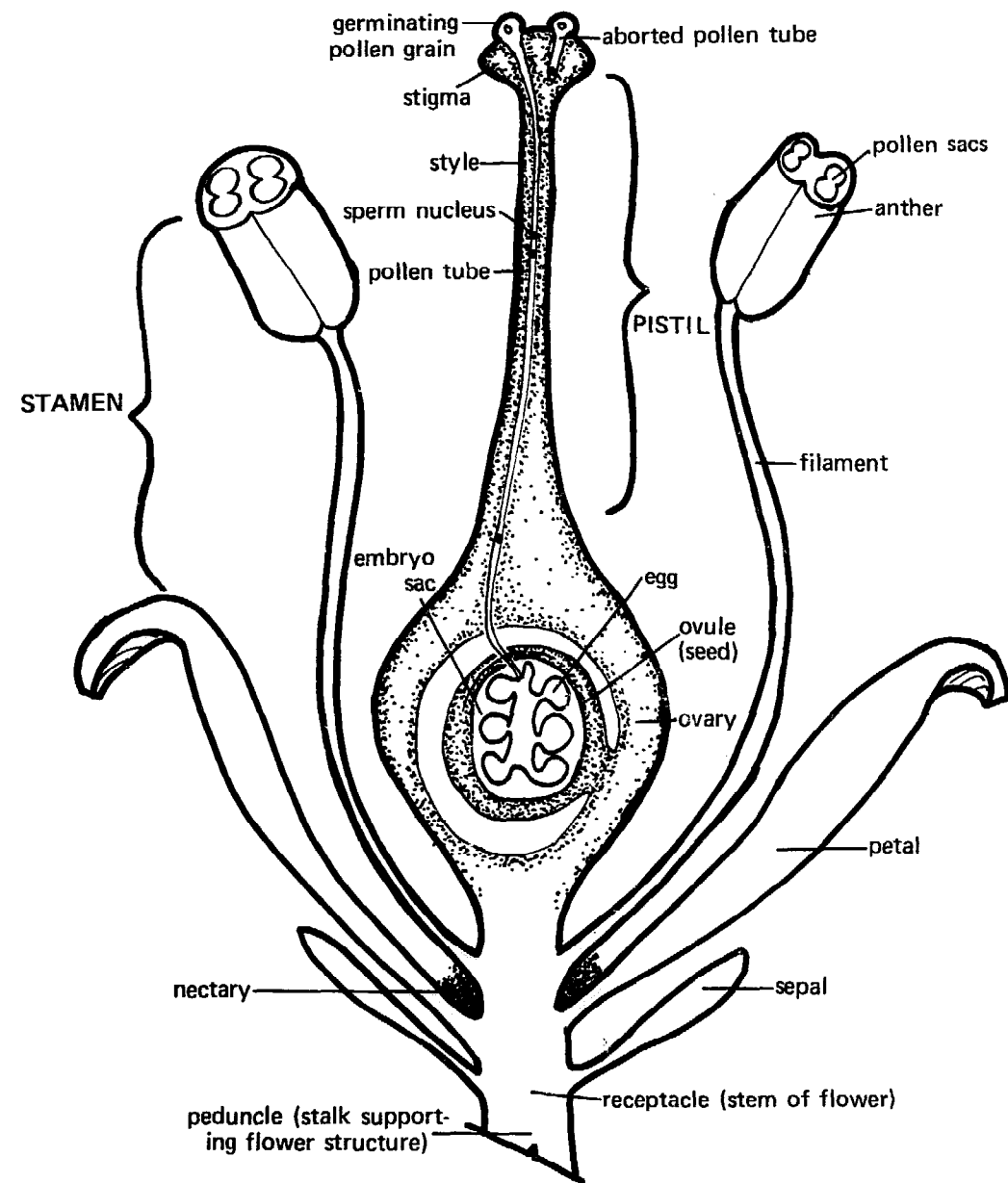

Appendices

Appendix A Bee Sting Reaction Physiology

LOCAL REACTION

What is happening in your body when you are stung by a bee? As with any bacterial invader the body's natural defenses are called to help. Basically bee venom is a foreign protein (called *antigen*) which stimulates the production of the body's defense proteins (called *antibodies*). Antibodies belong to a family of proteins known as gamma globulin and are also called immunoglobulins. The bee sting antigens appear to stimulate specific immunoglobulins known as *Immunoglobulin E* (written as *IgE* in the diagram).

Since the bee venom antigen reacts with specific antibodies (in this case the *IgE*), people not otherwise exposed to honey bee proteins must be stung at least once before any type of reaction will occur. After the initial inoculation, the body seems to "remember" that particular antigen and will be likely to react faster to subsequent stings, with

further antibody production.

In a local reaction, the antigen of the bee venom appears to react with the *IgE* bodies which are attached to tissue cells (called *mast cells*). Mast cells contain numerous vesicles filled with histamine and other substances promoting inflammation. The action of the antigen reaction with the *IgE*-mast cell complex seems to cause the histamine-filled vesicles to empty. Histamine, once released into the body, has several effects. These include the expansion of blood vessels (vasodilation), the increased permeability of capillary cell walls to proteins and fluids, and the constriction of the respiratory passages. The first two actions may be responsible for the inflammation, swelling, and itching associated with bee stings. Most beekeepers are reported to have this kind of *local reaction*. Upon repeated stings, the body becomes immune to the bee venom and the venom will probably cause little if any discomfort.

SYSTEMIC REACTION

In a systemic reaction, the same mechanisms as in the local reaction come into play, with one big difference: the antigen-*IgE*-mast cell complex reaction can cause death. This allergic reaction, called hypersensitivity, appears to be a result of the large amounts of histamine being released from the mast cells. Since the body remembers the bee venom antigen, the subsequent inoculations usually

cause a faster reaction, which means more histamine is released each time a person is stung. Usually, a systemic reaction builds up gradually, with the victim showing greater distress (like breathing difficulty) each time he is stung. In some people the second bee sting may be enough to kill them. An antihistamine and adrenaline (epinephrine) should be immediately administered to counteract the effects of the released histamine and give relief to breathlessness.

DESENSITIZATION OR IMMUNITY

People that develop hypersensitivity to bee stings can become desensitized. Most beekeepers become less sensitive or immune to bee stings after repeated exposure. Desensitization can also be undertaken by an allergist. In either case, the immune processes (desensitization) are probably the same. Frequent injections of the venom appear to induce the body to manufacture a "blocking" antibody, *IgG*. The *IgG* competes with the *IgE* in its reaction activities to bee venom antigens. Since the *IgG* antibodies are not fixed to mast cells but float freely, they seem to be better able to combine with the bee sting venom antigens. Less histamine is therefore released, and the discomfort or allergic response is prevented. What an allergist does is to control the amount of venom that the victim receives, allowing the body to form enough of these blocking antibodies to combat the allergic reaction.

There is evidence to support the idea that persons afflicted with hypersensitive reactions like asthma and hay-fever are more prone to allergic reactions to stinging insect antigens, but this increased risk is small.

Some beekeepers can, over long periods of time, even become allergic to beeswax, honey, bee debris and bodies, and propolis. The percentage of beekeepers that do become allergic to bee stings, although hard to assess since individual body chemistry and allergy history are so varied, is small. While most people will probably already know if they are allergic, those who do not can contact local allergy clinics or sometimes hospital out-patient facilities.

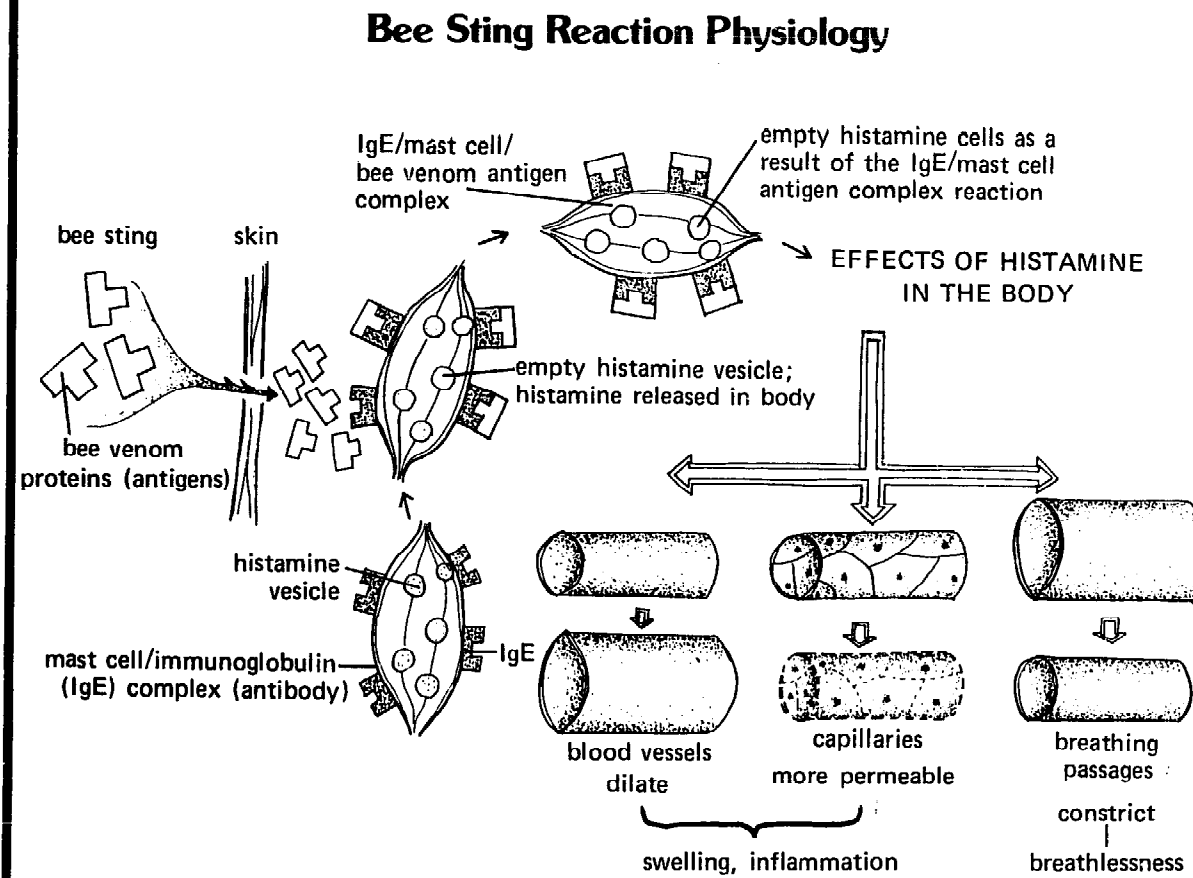

Appendix B Anatomy of the Honey Bee

INTRODUCTION

The anatomy of the honey bee is similar to that of other insects except for the specialization of certain organs and structures needed by bees to carry out functions peculiar to them. Parts common to other insects include: the three basic insect parts—head, thorax, and abdomen; the hard, waxy protein (chitin) covering; the free respiratory system (no lungs); the ventral or bottom spinal cord; and the free circulatory system (no veins). These are labeled and defined on the diagram Internal Organs of a Worker Honey Bee.

Some of the more specialized structures and functions not seen externally include the honey sac, the significance of the antennae and eyes, and the pheromones and glands of the bee.

HONEY SAC

The esophagus of the bee begins at the back of the mouth and continues through the thorax, terminating in the anterior part of the abdomen where it expands into the crop or honey sac. Collected nectar, honeydew, and water

are stored in this sac. Since the walls of the honey sac can expand readily due to invaginations, a heavy load of liquid can be carried in it. A valve at the posterior part of the sac called the *stomach mouth*, or proventriculus, controls whether or not the contents of the honey sac pass into the remaining parts of the alimentary canal. On returning to the hive, most of the contents of the honey sac are brought up and transferred to young hive bees who work the nectar with the proboscis for some time to remove moisture and then place it in cells for further drying.

ANTENNAE

Most of the tactile (touch) and olfactory (smell) receptors of bees are located on the antennal segments. These receptors guide bees both inside and outside the hive and enable them to differentiate between hive, floral, and pheromone odors. Once detected, odor and tactile stimulation is transmitted down the nerve cord from the brain, ending in the affected area.

PHEROMONES

Honey bee behavior both inside and outside the hive is regulated to a large extent by chemical substances called pheromones. Pheromones are secreted by an animal and trigger certain behavioral responses or physiological activities in other members of the same species. Important queen and worker pheromones are discussed below. Others are shown

on the illustration Glands and Some Muscles of the Worker Bee.

Queen Pheromones

Located in the mandibles of a queen's head are the *mandibular glands* which produce and secrete the pheromone called *queen substance* (9-oxodec-Trans-2-enoic acid). This substance elicits various responses in worker and drone honey bees. Inside the hive this substance has been shown to inhibit ovary development in workers and deters them from constructing queen cells. Its absence invokes the opposite response—queen cell construction is undertaken. (If bees are unsuccessful in rearing a replacement, ovary development takes place in worker bees.)

A swarm—either flying out of the hive or to a homesite or in a cluster—is aware of its queen's presence by means of the same substance. Queen substance also guides drones towards queens who are on mating flights.

Worker Pheromones

Three different chemical pheromones are produced by workers. Two of these are *alarm pheromones*. One alarm odor (isopentyl-acetate) is released from a membrane at the base of the sting. The dispersal of this chemical is enhanced by the fanning action of the bee secreting it. This substance stimulates bees to sting or fly at intruders.

Another alarm odor (2-heptanone) is released by the mandibular glands of

workers. Items anointed with this odor are attacked by bees.

A third pheromone is the *scenting* or *orientation odor* and is comprised of four chemicals (neralic, geranic, and citral acids and geraniol). This chemical complex is produced by the Nasanoff or scent gland near the dorsal tip of the abdomen. Dispersal of these substances is aided by the fanning action of bees secreting it. Upon smelling these chemicals, bees move towards the source (as in a swarm).

BEE VISION

Bees have five eyes—three simple (ocelli) and two compound. The compound eyes are composed of thousands of individual light-sensitive cells called ommatidia. It is with the compound eyes that bees perceive color, light, and directional information from the sun's ultraviolet rays.

The color range of bee vision has been shown to include the violet, blue, blue-green, green, yellow, and orange colors as well as ultraviolet light which is invisible to humans. Flowers which depend on bee pollination are within these color ranges since they compete with each other for available pollinators. Those plants which succeeded in attracting bees with their color, nectar, and pollen gained an edge over other plants during their evolutionary development.

The structures and arrangement of the ommatidia permits polarized light to pass through certain parts of each ommatidium at any given instance. The

sun's position and the bee's direction are the factors determining which section of the ommatidia will receive full, partial, or no light. The effect of this on the compound eye will be patterns of light, dark, or shaded regions. This pattern serves as a "compass" to the bee, giving directional information. The bee is able to continually monitor these shifting patterns as it flies and, if necessary, adjusts its course.

POLLEN-COLLECTING STRUCTURES

The hind legs of worker bees are specialized for collecting and carrying pollen. An inner segment on the hind leg is covered with numerous hairs, forming the pollen combs. Bees actively collect pollen by scraping it off of flowers with their jaws and legs; as the pollen is removed, a small amount of honey is added to make it sticky. Additional pollen adheres to the bee's body as it is being collected. The collected pollen is then transferred by the bee to areas on its body where it can be reached and removed by the pollen combs.

Removal of the pollen from the pollen combs is accomplished by rubbing the legs together so the pollen is squeezed from the inside to the outside of the legs. The pollen will deposit eventually into a depression called the pollen basket. When the baskets are full, the bee returns to the hive, backs into a cell, and deposits the pollen pellets. The hive bees will pack the pollen in solidly, eventually capping it with honey for winter stores.

Notes

Internal Organs of a Worker Honey Bee

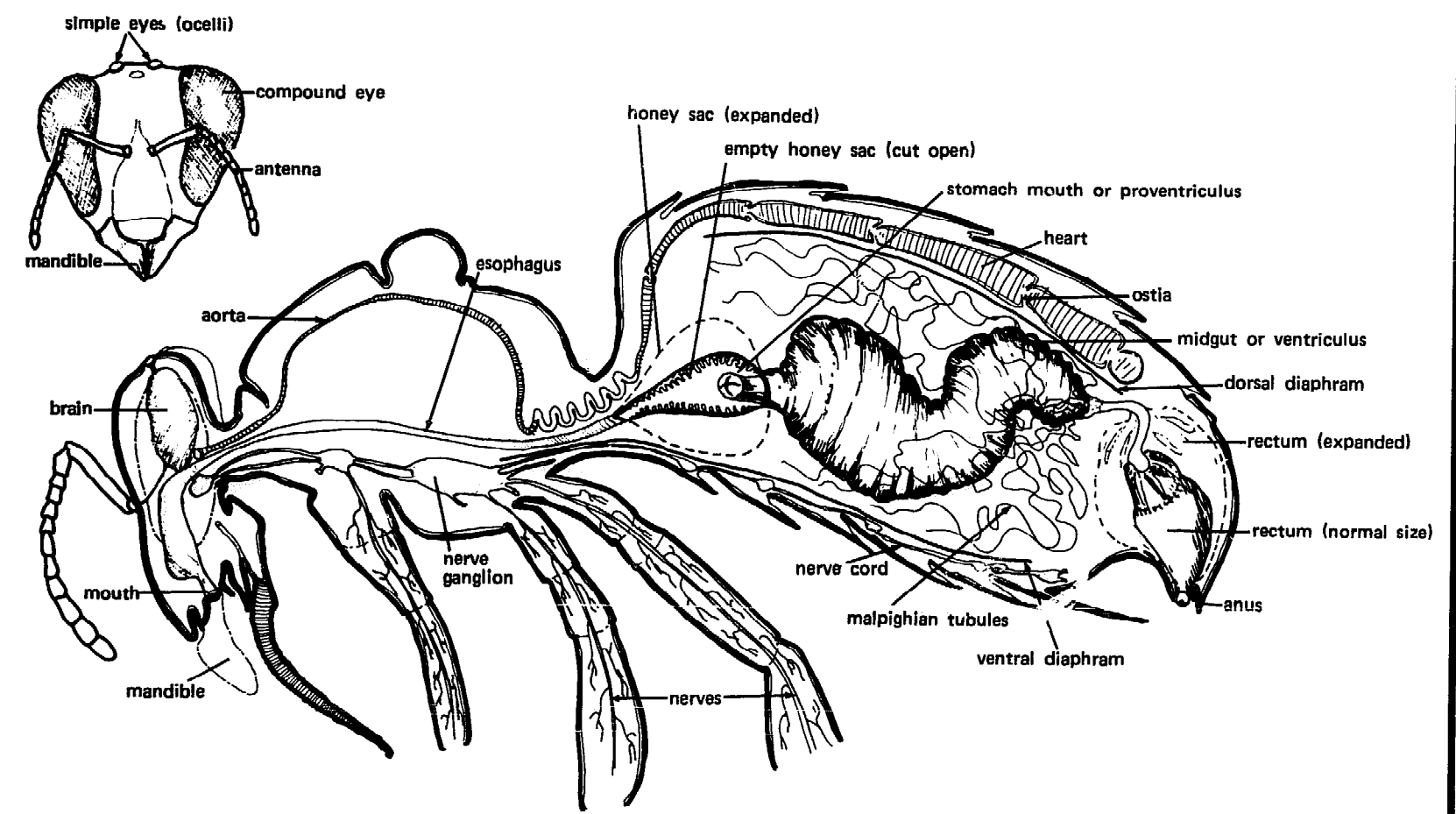

Adapted from: *The Hive and the Honey Bee*. Copyright © 1975 by Dadant & Sons, Hamilton, Illinois. Used by permission of Dadant & Sons.

Glands and Some Muscles of the Worker Honey Bee

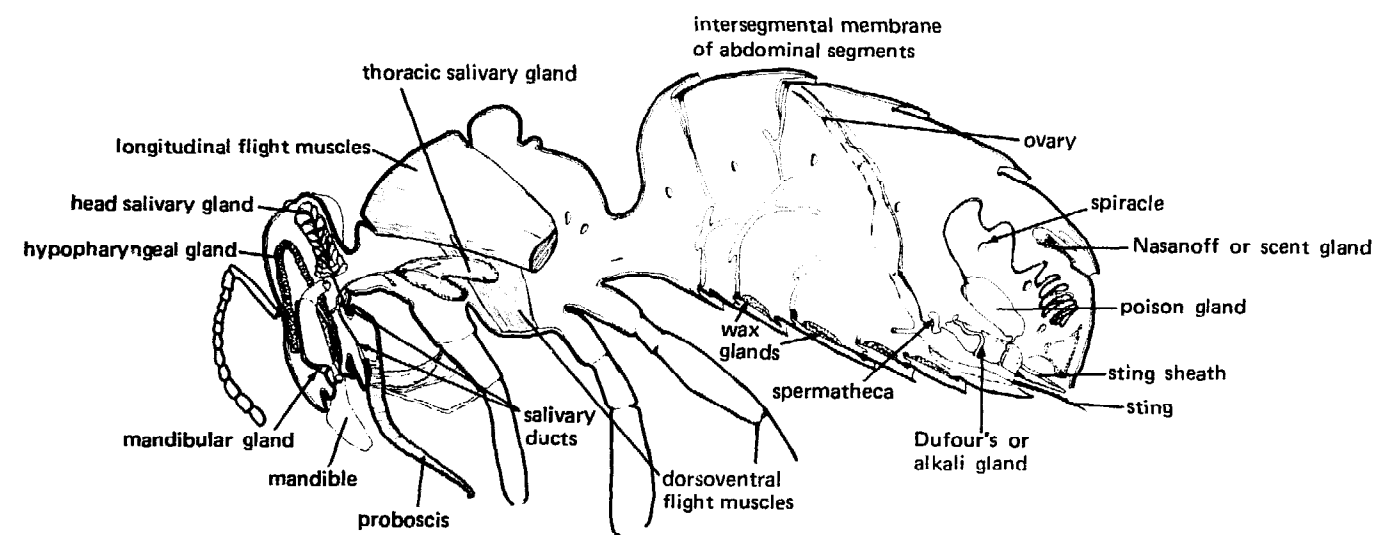

Adapted from a drawing by Barry Siler in Charles D. Michener: *The Social Behavior of Bees*. Copyright © 1974 by the President and Fellows of Harvard College. Used by permission of the publisher, The Belknap Press of Harvard University Press.

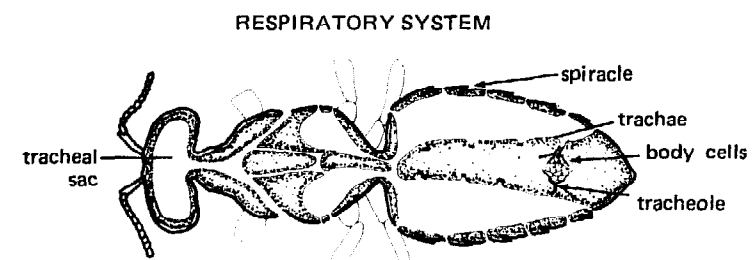
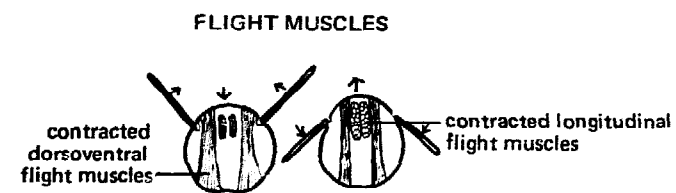

Adapted from R. E. Snodgrass: *Anatomy of the Honeybee*. Copyright © 1956 by Cornell University. Used by permission of Cornell University Press.

Appendix C Observation Hives

INTRODUCTION

Many beekeepers maintain observation hives in their homes or in some nearby enclosure. They are useful when teaching others about bees, without having to disturb or interrupt the activities of the colony. A lecture to a school or other groups on bees is enhanced if one can bring along an observation hive which practically does the talking for the lecturer. Observation hives are also used at fairs to attract people to the honey stands.

By observing bee activities in these hives, the beekeeper may obtain a general picture of what is taking place in his box hives.

BASIC COMPONENTS

Observation hives usually consist of two deep frames, or one deep and one shallow frame, or a deep frame with a comb section frame above it. A 3/8 inch bee space must be maintained between hive parts as in a regular hive. Glass or thick plexiglass can be used to enclose the frames. Plexiglass, although more expensive than glass, will reduce the likeli-

hood of an accident but might warp more easily and become scratched. An opening to the outside is necessary so that bees will be able to forage and perform their normal activities.

Kits for observation hives are available from most bee supply dealers. Plans for building these hives are also available.

INSTALLING BEES

Swarms or packages are somewhat difficult to install into an observation hive. The best way to install bees into this hive is by taking frames from an established hive. The deep frames should contain brood, some honey and plenty of adult bees. A new queen or queen cells can be introduced, or the queen from the old hive can be used, requeening that hive with a new queen.

Since new wax looks neater and cleaner than old comb (a selling factor if used with a honey display), a frame of foundation can be inserted into an established hive and, when it contains brood, it can be transferred to the observation hive. Another method to obtain a clean-looking observation hive would be to install a small swarm or package into a hive with foundation and feed it syrup. In five to six weeks several frames of brood and bees can be transferred to the observation hive.

To keep bees from building comb onto the glass, a *very* thin coating of Vaseline will keep bees off, but might distort viewers sight.

Notes

Appendix D Basic Hive Parts

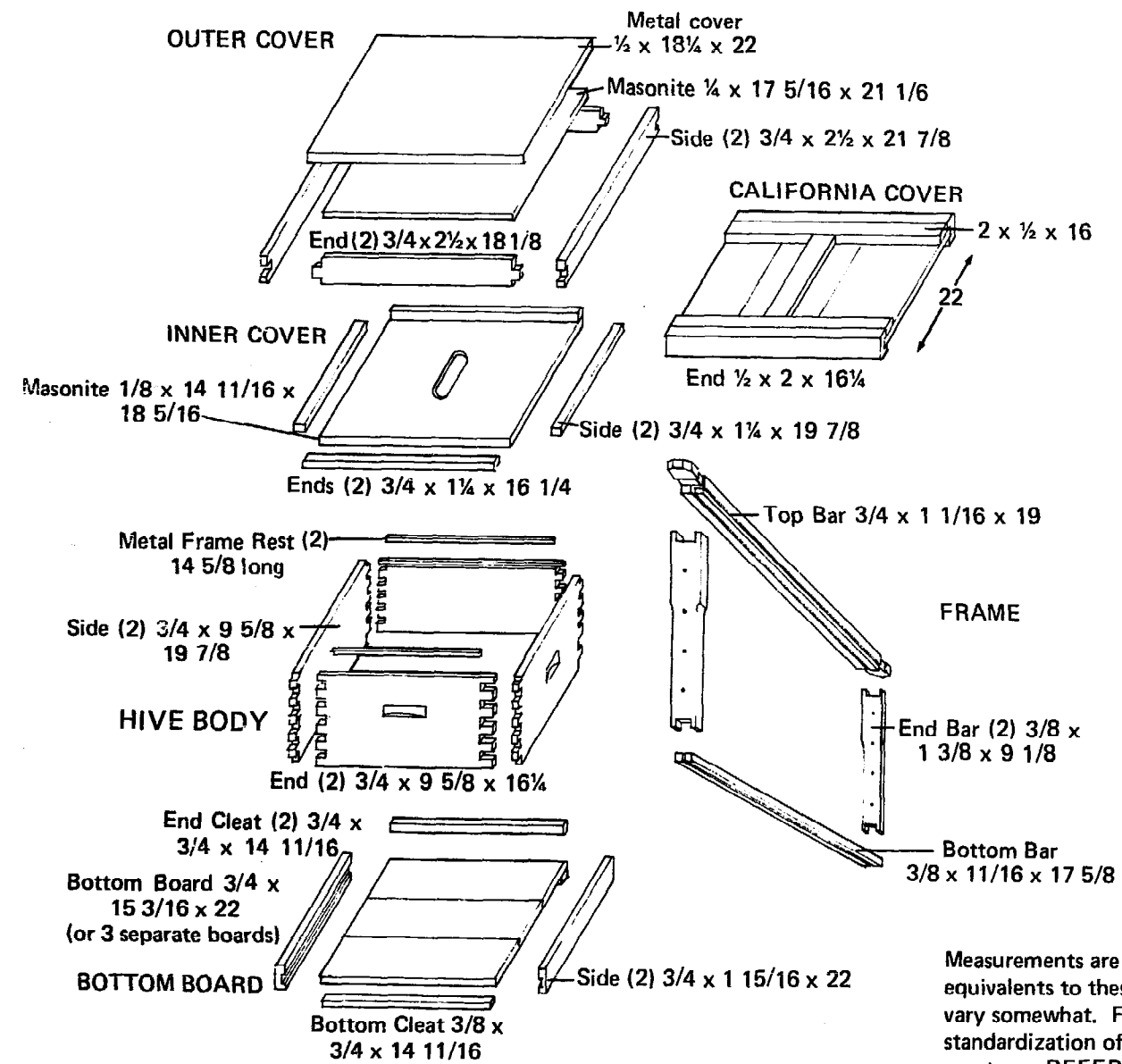

References

BEE STING REACTION

- Barnard, J. H. "Present Status of Therapy in Hymenoptera Sting Sensitivity." *Annals of Allergy* 29: 372-76, 1971.
- Barr, S. E. "Allergy to Hymenoptera Stings—Review of World Literature: 1953-1970." *Annals of Allergy* 29: 49-66, 1971.
- Busse, W. W., Reed, O. E., Lichtenstein, L. M., and Reisman, R. E. "Immunotherapy in Bee Sting Anaphylaxis." *JAMA* 231(11): 1154-6, 17 March 1975.
- Frankland, A. W. "Bee Sting Allergy." *Bee World* 57(4): 145-150, 1976.
- "Treatment of Bee Sting Reactions." *Bee World* 44(1): 9-12, 1963.
- Hildreth, E. A., and Kipp, J. E. "Economical Bee-Sting Kits." *Postgraduate Medicine* 57(7): 139-140, 1975.
- "Insect Stings, How to Protect Yourself." *U.S. News and World Report*. Interview with Dr. M. D. Valentine. 1976, p. 55.
- Lichtenstein, L. M., Valentine, M. D., and Sobotka, A. K. "Case for Venom Treatment in Anaphylactic Sensitivity to Hymenoptera Sting." *New England Journal of Medicine* 290(22): 1223-1227, 1974.
- Shulman, S. "Allergic Responses of Insects." *Annual Review of Ent.* 12: 323-347, 1967.
- Thomas, O. C., and McGovern, J. P. "Hymenoptera Insect Hypersensitivity." *Journal of School Health* XLIV(5): 271-76, 1974.
- Vander, A. J., Sherman, J. H., and Luciano, D. S. *Human Physiology, The Mechanisms of Body Function*. 2d ed. New York: McGraw-Hill, 1975.
- Solomon, W. R. Personal communications regarding bee sting reaction. University Hospital, Allergy Section. Ann Arbor: University of Michigan.

BOOKS ON BEES

- Butler, C. G. *The Honeybee*. Oxford: Clarendon, 1949.
- *World of the Honeybee*. New York: MacMillan, 1955.
- Crompton, J. *A Hive of Bees*. New York: Doubleday, 1958.
- Dade, H. A. *Anatomy and Dissection of the Honeybee*. Maidstone, Kent, England: Bee Research Assoc., 1961.
- Dyce, E. J. *Beekeeping Terms*. Dept. Ent. Ithaca: Cornell University Press, 1960.
- Hambleton, H. I. *Honey Bee*. Washington, D. C.: Smithsonian Publication #4494, 1962.
- Hoyt, M. *The World of Bees*. New York: Bonanza, Coward McCann, 1965.
- Insects*. USDA Yearbook. Washington, D.C.: GPO, 1952.
- Killion, C. E. *Honey in the Comb*. Paris, Illinois: Killion and Sons, 1951.
- Lindauer, M. *Communication Among Social Bees*. Cambridge: Harvard University Press, 1961.
- Mace, H. *Complete Handbook of Bee-Keeping*. London: Ward Lock, 1976.
- Mitchener, C. D. *The Social Behavior of the Bees*. Cambridge: Belknap Press of Harvard University Press, 1974.
- Morse, R. A. *Bees and Beekeeping*. Ithaca: Cornell University Press.
- *The Complete Guide to Beekeeping*. New York: Dutton & Co., 1972.
- Onstott, K. *Beekeeping as a Hobby*. New York: Harper & Bros., 1941.

- Phillips, M. G. *Makers of Honey*. New York: Crowell, 1956.
- Ribbands, R. *Behavior and Social Life of Honeybees*. London: Bee Research Assoc., 1953.
- Seeds*. USDA Yearbook. Washington, D. C.: GPO, 1961.
- Smith, F. G. *Beekeeping in the Tropics*. Bristol, England: Western Printing Service, 1960.
- Snodgrass, R. E. *Anatomy of the Honeybee*. Ithaca: Comstock, Cornell University, 1956.
- Von Frisch, K. *Animal Architecture*. New York: Harcourt-Brace, Jovhanovich, 1973.
- *Bees, Their Vision, Chemical Senses and Language*. Ithaca: Cornell University, 1971.
- *Dance Language and Orientation of Bees*. Cambridge: Belknap Press, 1967.
- *The Dancing Bees*. London: Methuen, 1954.
- Wenner, A. M. *The Bee Language Controversy: An Experience in Science*. Boulder, Colorado: Educ. Prog. Improvement Corp., 1971.
- Wilson, E. O. *The Insect Societies*. Cambridge: Belknap Press of Harvard University, 1971.

BOOKS ON BEES, HISTORIC

- Alley, H. *The Bee-Keeper's Handy Book*. Massachusetts: A. Wenham, 1883.
- Atkins, W. and Hawkins, K. *How to Succeed with Bees*. Watertown, Wisconsin: G. B. Lewis, 1924 (1st ed.) and 1937 (16th ed.).
- Bee and Honey Patents of the World*. Arlington, Virginia, 1969.
- Beekeeping*. Small Holding Series #9. Can. Legion Ed. Serv. Ottawa, 1946.
- Bonsels, W. *Adventures of Maya the Bee*. New York: T. Seltzer, 1922.
- Coleman, M. L. *Bees in the Garden and Honey in the Larder*. New York: Doubleday, Doran, 1939.

- Comstock, A. B. *How to Keep Bees*. New York: Doubleday, Page, 1905.
- Cook, A. J. *The Beekeeper's Guide*. East Lansing: Michigan Agricultural College, 1888.
- Cowan, T. W. *Wax Craft*. London: Sampson Low, Marston, 1908.
- Dadant, C. P. *Dadant System of Beekeeping*. Hamilton, Illinois: American Bee Journal, 1920.
- Edwards, T. *The Lore of the Honey-Bee*. London: Methuen, 1923.
- Flower, A. B. *Beekeeping Up to Date*. London: Cassell & Co., 1925.
- Hawkins, K. *Beekeeping in the South*. Hamilton: Amer. Bee Journal, 1920.
- Herrod-Hempsall, W. *Beekeeping New and Old*. Vol. I & II. London: British Bee Journal, 1930.
- Dadant, C. P. trans. *Huber's Observations on Bees*. Hamilton: Amer. Bee Journal, 1926.
- Lyon, D. E. *How to Keep Bees for Profit*. New York: Grosset & Dunlap, 1910.
- Maeterlinck, M. *Life of the Bee*. New York: Dodd-Mead, 1924.
- Naile, F. *Life of Langstroth*. Ithaca: Cornell University Press, 1942.
- Pellett, F. C. *The Romance of the Hive*. New York: Abingdon, 1931.
- *A Living from Bees*. New York: Orange Judd, 1946.
- Phillips, E. F. *Beekeeping*. New York: MacMillan, 1943.
- Quinby, M. *Mysteries of Beekeeping*. New York: Orange Judd, 1866.
- Sechrist, E. L. *The Bee Master*. Roscoe, California: Earthmaster, 1947.
- *Amateur Beekeeping*. New York: Devin-Adair, 1955.
- Snelgrove, L. E. *Swarming, Its Control and*

- Prevention*. Weston-Super-Mare, England: Snelgrove, 1946.
- Stuart, F. S. *City of the Bees*. New York: McGraw-Hill, 1947.
- Teale, E. W. *The Gold Throng*. New York: Dodd-Mead, 1945.
- Webb, A. *Beekeeping for Profit and Pleasure*. New York: MacMillan, 1944.

DISEASES

- American Foulbrood, A Disease of the Honey Bee*. Agri. Res. Ser. #CA 33-26. Beltsville, Maryland: Ent. Res. Div. USDA, 1967.
- Clark, W. W., Jr. *Diseases of Bees and Their Control*. Ext. Ser. Circular #527. University Park: Pennsylvania State University.
- Conner, L. J. *Honey Bee Diseases and Other Bee Pests*. Coop. Ext. Ser. Bull. #582. Columbus: Ohio State University.
- A Comparison of Symptoms of Various Brood Diseases of Honey Bees*. Ent. Res. Div. #CA 33-29. Beltsville, Maryland: Agri. Res. Ser. USDA, 1967.
- Controlling the Greater Wax Moth*. Farmer's Bull. #2217, Washington, D. C.: GPO, 1967.
- *Wax Moths and Their Control*. Coop. Ext. Service Ithaca: Cornell University, 1964.
- Directions for Sending Diseased Brood and Bees for Diagnosis*. Ent. Res. Div. #CA 33-30. Beltsville, Maryland: Agri. Res. Ser. USDA, 1967.
- Dyce, E. J. *A Comparison of Characteristics Useful in the Diagnosis of Brood Diseases of Bees*. Coop. Ext. Serv. Ithaca: Cornell University.
- Dysentery in Bees*. Advisory Leaflet #566. Edinburgh, Scotland: HMSO Press.
- European Foulbrood, A Disease of the Honey Bee*. Ent. Res. Div. #CA 33-25. Beltsville, Maryland: Agri. Res. Ser. USDA, 1967.
- Examination of Bees for Acarine*. Advisory Leaflet #362. Edinburgh, Scotland: HMSO Press, 1972.
- Foul Brood*. Advisory Leaflet #306. Edinburgh, Scotland: HMSO Press, 1967.
- Furgala, B. *Chemical Control of Bee Diseases*. Agr. Res. Ser. Ent. #45. St. Paul: University of Minnesota, 1973.
- Identifying Bee Diseases in the Apiary*. Agr. Info. Bull. #313. Washington, D. C.: GPO, 1967.
- Martin, E. C. *Preventing and Controlling American Foul Brood*. Bee Mimeo Series #10. East Lansing: Michigan State University.
- Michael, A. S. *American Foulbrood of Honey Bees—How to Control It*. Farmer's Bull. #2074. Washington, D. C.: GPO, 1954.
- Murphey, M., and Haynie, J. D. *Chemical Treatment for Prevention of Bee Diseases*. Coop. Ext. Work in Agri. and Home Economics. Washington, D. C.: USDA, Florida State University and University of Florida.
- Nosema and Amoeba*. Advisory Leaflet #473, HMSO Press, Edinburgh, Scotland, rev. 1972.
- Nosema Disease of the Honey Bee*. Agr. Res. Ser. #CA 33-27. Beltsville, Maryland: Ent. Res. Div. USDA, 1967.
- Sacbrood, A Disease of the Honey Bee*. Agr. Res. Serv. #CA 33-28. Beltsville, Maryland: Ent. Res. Div. USDA, 1967.
- Shimanuki, H. *Identification and Control of Honey Bee Diseases*. Farmer's Bull. #2255. Washington, D. C.: GPO, 1977.
- Whitcomb, Jr. *Controlling the Greater Wax Moth—A Pest of Honeycomb*. Farmer's Bull. #2217. Washington, D. C.: GPO, 1967.

EQUIPMENT

- Detroy, B. F., and Owens, C. D. "Evaluation of Plastic Combs for Honey Bees." *Am. Bee Journal* 113(3): 54-55, 1973.
- Dyce, E. J. *Wood Preservatives and Their Application*. Coop. Ext. Ser. Ithaca: Cornell University, 1950.
- Miller, S. R. *Let's Build A Bee Hive*. Phoenix, Arizona: 2028-A. W. Sherman St., 1976.
- Owens, C. D., and Detroy, B. F. *Selecting and Operating Beekeeping Equipment*. Farmer's Bull. #2204. Washington, D. C.: GPO, 1965.
- Plans and Dimensions for a 10-Frame Bee Hive*. Ag. Res. Serv. #CA 33-24. Beltsville, Maryland: Ent. Res. Div. USDA.
- A Simplified Pollen Trap for Use on Colonies of Honey Bees*. Agri. Res. Serv. #33-111. Beltsville, Maryland: Ent. Res. Div. USDA, 1966.
- Stanger, W., and Parsons, R. A. *Beehive: California Plan*. Coop. Ext. Serv. #217. Berkeley: University of California, 1974.
- Walton, G. N. "The Metrication of Beekeeping Equipment." *Bee World* 56(3): 109-119, 1975.

FEEDING BEES

- Harp, R. R. *A Simplified Pollen Trap for Use on Colonies of Honey Bees*. Agri. Res. Ser. #33-111. Washington, D. C.: USDA, 1966.
- Furgala, B. *Pollen Substitutes and Supplements*. Fact Sheet, Entomology #24. Agri. Ext. Ser. St. Paul: University of Minnesota, 1973.
- Haydak, M. H. "Honey Bee Nutrition." *Annual Review of Entomology* (15): 143-155, 1970.
- Little, L. H. *How to Feed Bees*. Agri. Ext. Ser. Circular #517. Tennessee Dept. of Agri. and University of Tennessee.

- Makar, S. *New Concept for Pollen Trapping*. University of Wisconsin Bull. #568. Experimental Station. Madison: University of Wisconsin.
- Nye, W. P., and Knowlton, G. F. *Pollen Supplement for Honey Bees*. Ext. Ser. EL 138. Logan: Utah State University.
- Standifer, L. N., Haydak, M. H., Mills, J. P., and Levin, M. D. "Influence of Pollen in Artificial Diets on Food Consumption and Brood Production in Honey Bee Colonies." *Amer. Bee Journal* 113(3): 94-95, 1973.
- Supplemental Pollen Feeding*. Bee Management Investigations. Madison: University of Wisconsin.

HONEY

- A Cloth Strainer for Honey Conditioning Systems*. Production Research Report #90. Washington, D. C.: GPO, 1966.
- Beck, B. F. *Honey and Health*. New York: McBride, 1938.
- and Smedley, D. *Honey and Your Health*. New York: McBride, 1944.
- Crane, E., Ed. *Honey*. London: W. Heine-mann Ltd. and Int. Bee Res. Assoc., 1975.
- Dyce, E. J. *Finely Crystallized or Granulated Honey, General Information*. Dept. Ent., Ithaca: Cornell University, 1961.
- *Marketing Honey*. Ithaca: Cornell University, 1961.
- *Some Basic Requirements for an Efficient Honey House*. Dept. Ent. Ithaca: Cornell University, 1961.
- and Morse, R. A. *Methods of Removing Honey from Colonies*. Dept. Ent. Ithaca: Cornell University, 1968.
- Haydak, M. H., Palmer, L. S., Tanquary, M. C., and Vivino, A. E. "The Effect of Commercial Clarification on the Vitamin Content of Honey." *Journal of Nutrition* 26: 319-321, 1942.

- How to Get Along With Your Back*. Fact Sheet. McNeil Labs. Inc., Ft. Washington, Pennsylvania, 1934.
- Knott, M. C., Shukers, C. F., and Schlutz, F. W. "The Effect of Honey Upon Calcium Retention in Infants." *Journal Pediatrics* 19: 485-494, 1941.
- Martin, E. C. *Scale of Points for Judging Honey*. Dept. Ent. E. Lansing: Michigan State University.
- "Some Aspects of Hygroscopic Properties and Fermentation of Honey." *Bee World* 39: 165-178, 1958.
- Morse, R. A. *General Information on Making Honey Wine at Home*. Dept. Ent. Ithaca: Cornell University, 1966.
- *Notes and Annotated Bibliography on the Manufacture of Honey Jelly*. Dept. Ent. Ithaca: Cornell University, 1957.
- Smith, M. R., McCaughey, W. F., and Kemmerer, A. R. "Biological Effects of Honey." *Journal Apic. Res.* 8: 99-110, 1969.
- Townend, G. F. *Preparation of Honey for Market*. Ont. Dept. Agri. Pub. #544. Toronto, 1961.
- White, J. W., Jr. "Toxic Honeys." In *Toxicants Occurring Naturally in Foods*. Committee on Food Protection, National Res. Council, pp. 195-507. Washington, D. C.: National Academy of Sciences, 1973.
- Riethof, M. L., Subers, M. H., and Kushnir, I. *Composition of American Honey*. USDA Tech. Bull. #1261. Washington, D. C.: GPO, 1962.

HONEY COOKBOOKS

- A Book of Favorite Recipes*. Michigan Beekeepers Assoc. Circulation Service, Kansas City, Missouri: 1977.
- Brogdon, P. C. *Preserve with Honey?* Coop. Ext. Serv. Chattanooga, Tennessee.
- Caron, D. M. *Honey*. Coop. Ext. Serv. Ent.

Leaflet #85. College Park: University of Maryland.

Cookin' with Honey. Rochester, Minnesota: Minnesota Beekeepers Assoc.

Drops of Gold. Ohio Dept. Agri., Columbus: National Graphics.

Gems of Gold, With Honey. Box 32, Whittier, California: Honey Advisory Board.

Gross, S. *The Honey Book.* St. Charles, Illinois: Kitchen Harvest Press, 1974.

Honey Cookery. Grand Rapids, Michigan: Woodman Co., 1969.

Honey Market News. Fruit and Vegetable Div., Agri. Marketing Serv. Washington, D. C.

Honey Recipe Book. Iowa Honey Producers Assoc. Des Moines, Iowa: Iowa Dept. of Agri., 1971.

Honey Sales. PL 89-755. Washington, D. C.: Food and Drug Administration.

Honey Sampler. Chicago: American Honey Advisory Board.

Honey—Some Ways to Use It. Home and Garden Bull. #37. Washington, D. C.: USDA, 1953.

Kees, B. *Cook with Honey.* Brattleboro, Vermont: Stephen Greene Press, 1973.

LoPinto, M. *Eat Honey and Live Longer.* New York: Twayne, 1957.

Milk and Honey Treasures. Madison: American Honey Institute.

Ness, Rev. M. H. *Honey—I Love You.* Denver: Nutri Books.

Old Favorite Honey Recipes. Madison: Amer. Honey Institute, 1945.

Perlman, D. *The Magic of Honey.* New York: Galahad, 1971.

Treasured Honey Recipes. Whittier, California: Honey Advisory Board.

HONEY PLANTS

Arnold, L. E. *Some Honey Plants of Florida.*

Bull. #548. University of Florida Agri. Experimental Station. Gainesville: University of Florida, 1954.

Blake, S. T., and Roff, C. *The Honey Flora of Queensland.* Dept. of Agri. and Stock. Brisbane: Australia, 1959.

Lovell, H. B. *Honey Plants Manual.* Medina, Ohio: A. I. Root Co., 1956.

Lovell, J. H. *Honey Plants of North America.* Medina, Ohio: A. I. Root Co., 1926.

Morton, J. F. *Honeybee Plants of South Florida.* Reprinted from Vol. 77 of the Proceedings of the Florida State Horticultural Society. Miami: Horticultural Society, 1964.

"Nectar and Pollen Plants." In *Beekeeping in the United States.* Agricultural Handbook #335. Agri. Res. Ser. Washington, D. C.: USDA, 1967.

Oertel, E. *Honey and Pollen Plants of the United States.* Circular #554. Washington, D. C.: USDA, 1939.

Pellett, F. C. *American Honey Plants.* Hamilton, Illinois: Dadant and Sons, 1976.

Vansell, G. H. *Nectar and Pollen Plants of California.* Bull. #517. California Agri. Extension Service, 1931.

JOURNALS AND OTHER PUBLICATIONS

American Bee Journal. Dadant and Sons, Hamilton, Illinois 62341.

Apiacta. Apimondia, Italy, Roma, Corso Vittorio Emanuele 101.

L'Apicoltura Moderna. via Ormea 99, 10126 Torino, Italy.

Australian Bee Journal. Peter Green Secretary, Victorian Apiarist Assoc., P. O. Box 137, Noble Park, Vic., 3174 Australia.

Australian Beekeeper. Pender Bros. Pty. Ltd., Box 20, P. O. Maitland 3n, N. S. W. 2320, Australia.

Bee Craft. British Beekeepers Assoc. The Secretary, 15, West Way, Copthorne Bank, Crawley, Sussex, RH 10 3DS.

British Bee Journal. 46 Queen Street, Geddington, Nr. Kettering, Northants NN14 1AZ, England.

Canadian Bee Journal. Port Hope, Ontario, Canada.

Canadian Beekeeping. Box 128, Orono, Ontario, Canada.

Gleanings in Bee Culture. A. I. Root Co., Medina, Ohio 44256.

Indian Bee Journal. All India Beekeepers' Association, 727 (new) Sadashiv Peth, Poona 411 030, India.

International Bee Research Assoc. Hill House, Chalfont St. Peter, Gerrards Cross, Bucks., SL9 0NR. (Publications: *Bee World*, *Apicultural Abstracts*, *Journal of Apicultural Research*.)

Irish Beekeeping. James J. Doran, St. Jude's, Mooncoin, Waterford, Ireland.

New Zealand Beekeeper. Trevor Walton, Box 176, Carterton, New Zealand.

Scottish Bee Journal. R. N. H. Skilling, 34 Renie St., Kilmarnock, Ayrshire, Scotland.

The Scottish Beekeeper. R. G. Brown, Richmond Ave., Dumfries, Scotland.

South African Bee Journal. P. O. Box 1675 Irene, Republic of South Africa.

Speedy Bee. Route 1, Box G-27, Jessup, Georgia 31545.

Other Sources:

Journal of Economic Entomology

Annual Review of Entomology

Monthly publications from state agricultural colleges, state beekeeping organizations, and agricultural extension services.

MANAGEMENT OF BEE COLONIES

Dunham, W. E. *The Modified Two-Queen*

- System for Honey Production.* Ohio Agri. Ext. Bull. #281. Columbus, 1947.
- Dyce, E. J., and Morse, R. A. *Wintering Honey Bees in New York State.* Ext. Bull. #1054. Coop. Ext. Serv. Ithaca: Cornell University, 1960.
- Farrar, C. L. *Productive Management of Honeybee Colonies in the Northern States.* Circular #702. Washington, D. C.: USDA, 1944.
- General Spring Management.* Coop. Ext. Serv. Ithaca: Cornell University.
- Johansson, T. S. K., and Johansson, M. P. "Wintering." *Bee World* 50(3): 89-100, 1969.
- "Winter Losses 1970." *Amer. Bee Journal*, 111(1): 10-12, 1971.
- Luening, R. A., and Gojmerac, W. L. *Beekeeping Records.* Coop. Ext. Serv. #A2655. Madison: University of Wisconsin.
- Michael, A. S. "Bee Laws of the United States." *Amer. Bee Journal* 116(7): 308-309, 340, 1976.
- Moeller, F. E. *The Relationship Between Colony Populations and Honey Production.* Production Research Reports #55. Washington, D. C.: USDA, 1961.
- Shaw, F. R. *Bee Management Through the Year.* USDA Dept. Ent. Insect Information. Amherst: University of Massachusetts, 1955.
- Spring Management of Honey Bees.* Dept. Ent. and Plant Pathology Circular #241. Amherst: University of Massachusetts, 1958.
- Shaw, F. R., and Whitehead, S. B. *Honeybees and Their Management.* New York: van Nostrand, 1951.
- Smith, M. V. *Caring for Bees in Schools.* Ontario Dept. Agri. Publication #169. Toronto, 1971.
- Two-Queen Colony Management for Production of Honey.* Agri. Res. Serv. #33-48. Beltsville, Maryland, 1958.

- How to Produce Comb Honey.* A. I. Root Co., Leaflet #5127-Qzm-872. Medina, Ohio.
- How to Produce Honey.* Ext. Ent. Newsletter #60. Logan: Utah State University, 1970.
- Williams, H. E. *Supering Honeybee Colonies.* Agri. Biol., Agr. Ext. Service. Washington, D. C.: USDA, 1974.

NURSERIES AND PLANT CATALOGUES

- Brooklyn Botanical Garden Handbooks, 1000 Washington Ave., Brooklyn, New York 11225
- W. Atlee Burpee Seeds, Warminster, Pennsylvania 18974
- Caprilands Herb Farm, Coventy, Connecticut
- Emlong's, Stevensonville, Michigan 49127
- Farmer Seed & Nursery Co., Faribault, Minnesota 55021
- Fox Hill Farms (Herbs), Box 7, Parma, Michigan 49269
- Garden Way Gardener's Marketplace, 509 Westport Ave., Norwalk, Connecticut 06851
- Hemlock Hill Herb Farm, Litchfield, Connecticut 06759
- Interstate Nurseries, Hamburg, Iowa
- J. W. Jung Seed Co., Randolph, Wisconsin 53956
- Kelly Bros., Nurseries, Dansville, New York 14437
- Lakeland Nurseries, Hanover, Pennsylvania 17331
- McMinnville Tree Farm, Highway 55, McMinnville, Tennessee 37110
- Mellinger's, 2310 West South Range Road, N. Lima, Ohio 44452
- Merry Gardens (Herbs), Camden, Maine 04843
- Nichols Herb and Rare Seeds, 1190 N. Pacific

- Highway, Albany, Oregon 97231
- L. L. Olds Seeds, P. O. Box 7790, 2901 Packers Ave., Madison, Wisconsin 53707
- Geo. W. Park Seeds, Greenwood, South Carolina 29647
- Pellett Gardens (Honey Plants), Atlantic, Iowa 50022
- Rayner's Berry Book (Nursery), Salisbury, Maryland 21801
- Rocky Mt. Seed Co., 1325-15th St., Denver, Colorado 80217
- Schumway's, Rockford, Illinois 61101
- Spring Hill Nurseries, 110 Elm St., Tipp City, Ohio 45371
- Stark Bros. Nurseries, Louisiana, Missouri 63353
- Stokes Seeds, Inc., Box 548, Buffalo, New York 14240
- Suttons Seeds, Ltd., London Road, Earley, Reading, Berkshire, RG6 1AB England
- Thompson & Morgan, 401 Kennedy Blvd., Somerdale, New Jersey 08083

ORGANIZATIONS, U.S.

- American Beekeeping Federation. Robert Banker, Secretary, Rt. #1, Box 68, Cannon Falls, Minnesota 55009
- American Honey Producers Association. Glenn Gibson, P. O. Box 386, Minco, Oklahoma 73059
- American Bee Breeders Association. Louis Harbin, Secretary, P. O. Box 218, Theodore, Alabama 36582
- California Bee Breeders Association. Clarence Wenner, Secretary, Rt. #1, Box 283, Glenn, California 95942
- Eastern Apicultural Society, Mrs. Marie Morse, Acting Secretary, Cornwall Bridge Road, Sharon, Connecticut 06069
- State Beekeeping Organizations. Check your state.

PACKAGE BEES

- Beginning With Package Bees.* A. I. Root Co. #5122-QZM-872. Medina, Ohio, undated.
- Combs, G. F. and Morse, R. A. *Package Bees: Their Installation and Immediate Care.* Biological Science, Information Bulletin #7. Ithaca: Cornell University, 1974.
- Martin, E. C. *Package Bees in Michigan.* Dept. Mimeo. East Lansing: Michigan State University, 1965.
- Package Bees.* Booklet #2, Dadant and Sons, Inc. Hamilton, Illinois.

PAMPHLETS

- Bees . . . for Pleasure and Profit.* Medina, Ohio: A. I. Root, Co.
- Beekeeping.* Agri. Ext. Ser., Insect Notes #1. Raleigh: State University of North Carolina, 1974.
- Beekeeping for Beginners.* Home and Garden Bulletin #158. Washington, D. C.: GPO, 1974.
- Beekeeping in Alaska.* Coop. Ext. Ser. #701. Juno: University of Alaska.
- Beekeeping in Tennessee.* Agri. Ext. Ser. Publication #697. Knoxville: University of Tennessee, 1975.
- Beginning With Bees.* Booklets #1 through #5. Hamilton, Illinois: Dadant and Sons, Inc.
- Burgin, C. J. *Introduction to Beekeeping.* Ext. Ent., B-153. College Station: Texas A & M University, 1974.
- Caron, D. M. *Beekeeping in Maryland.* Ext. Bull. #223. Coop. Ext. Ser. College Park: University of Maryland, 1967 and 1975.
- *Ten Tips for Suburban Beekeepers.* Coop. Ext. Ser. Leaflet #75. College Park: University of Maryland, 1973.
- Clark, W. W., Jr. *Pennsylvanian Beekeeping.* Ext. Ser. Circular #544. University Park: Pennsylvania State University, 1971.
- The City of Bees.* Medina, Ohio: A. I. Root, Co.
- Conner, L. J. *Honeybees and You.* Coop. Ext. Ser. Bull. #585. Columbus: Ohio State University.
- Controlling Wasps.* Home and Garden Leaflet #122. Washington, D. C.: USDA, 1967.
- Dyce, E. J., and Morse, R. A. *Beekeeping: General Information.* Ext. Bull. #833. Ithaca: Cornell University.
- *Removing Colonies of Honey Bees from Buildings.* Coop. Ext. Ser. Ithaca: Cornell University, 1967.
- Eckert, J. A., and Bess, H. A. *Fundamentals of Beekeeping in Hawaii.* Ext. Bull. #55. Honolulu: University of Hawaii, 1952.
- Farrar, C. L. *Life of the Honey Bee.* Ext. Bull. #A-2279. Madison: University of Wisconsin, 1967.
- Haydak, M. H. *Beekeeping in Minnesota.* Ext. Bull. #204. St. Paul: University of Minnesota, 1968.
- Jaycox, E. R. *Beekeeping in Illinois.* Coop. Ext. Circular #1000. Champaign-Urbana: University of Illinois, 1969.
- *Beekeeping in the Midwest.* Champaign-Urbana: University of Illinois Press, 1976.
- *Destroying Bees and Wasps.* Coop. Ext. Ser. Circular #1011. Champaign-Urbana: University of Illinois, 1969.
- Johanson, C. *Beekeeping.* PNW Bulletin #79. Corvallis: Washington State University, 1974.
- Kissinger, W. A. *Beekeeping in Montana.* Manuscript. Helena, Montana: Department of Agriculture.
- Little, L. H., and Wallace, L. D. *A Bee Book for Bee-ginners.* Nashville: Tennessee Dept. of Agriculture, 1972.
- Martin, E. C. *Basic Beekeeping.* Farm Science Series, #E625. East Lansing: Michigan State University, 1971, rev. 1975.
- Morse, R. A. *The Honeybee and Its Relatives.*

- Coop. Ext. Ser. Ithaca: Cornell University, 1966.
- Nye, W. P., and Knowlton, G. F. *Beekeeping for Beginners.* Ext. Leaflet #111. Logan: Utah State University.
- O'Dell, W. T. *Beekeeping in South Carolina.* Ext. Ser. Clemson: University of South Carolina.
- Rahmlow, H. J. *Beekeeping in Wisconsin.* Ext. Circular #659. University of Wisconsin, 1968.
- Scheibner, R. A. *Beginning Beekeeping for Kentuckians.* Miscellaneous #361. Lexington: University of Kentucky.
- Scott, H. E., Hillmann, R. C., and Greene, H. F. *Honey Bees in North Carolina.* Agri. Ext. Ser. #512. Raleigh, North Carolina, 1975.
- Shade and Water for the Honey Bee Colony.* Leaflet #530. Washington, D. C.: GPO, 1964.
- Shaw, F. R. *Beekeeping.* Coop. Ext. Ser. #148. Amherst: University of Massachusetts, 1963.
- Standifer, L. N. *Beekeeping in the United States.* Agri. Handbook #335. Washington, D. C.: USDA, 1967.
- Stanger, W. *Beginning in Beekeeping.* Experimental Station Leaflet #183. Davis: University of California, 1965.
- Stephen, W. A. *Ohio Bee Lines.* Coop. Ext. Bull. #450. Columbus: Ohio State University, 1971.
- Walstrom, W. T., Kantack, B. H., and Berndt, W. L. *Beekeeping in South Dakota.* Coop. Ext. Bull. #EC 565. Brookings: South Dakota State University.
- Wasps—How to Control Them.* Leaflet #365. Washington, D. C.: USDA, 1954.
- Wilson, W. T., and Brewer, J. W. *Beekeeping in the Rocky Mountain Region.* Coop. Ext. Ser. Fort Collins: Colorado State University, 1974.

PESTICIDES

- Anderson, L. D., and Atkins, E. L., Jr. "Use of Pesticides in Beekeeping." *Annual Review of Entomology* 13: pp. 213-238, 1968.
- Atkins, E. L., Anderson, L. D., Nakakihara, H., and Greywood, E. A. *Toxicity of Pesticides to Honey Bees*. One-Sheet Answers, #170. Coop. Ext. Ser. Berkeley: University of California, 1974.
- Jaycox, E. R. *Pesticides and Honey Bees*. Circular #940. Coop. Ext. Ser. Champaign-Urbana: University of Illinois.
- Johansen, S. A. "Summary of the Toxicity and Poisoning Hazard of Insecticides to Honey Bees." Table I. *Bee World* 47(1): 1966.
- Martin, E. C. *Pesticides and Honey Bees*. Farm Science Series, Ext. Bull. E-678. East Lansing: Michigan State University, 1970.
- Minnick, F. A., and Robinson. *Pesticides and Bees*. Coop. Ext. Ser. Circular #386. Gainesville: University of Florida.
- Noetzel, D. M. *Protection of Honey Bees From Insecticides*. Agri. Ext. Ser. Ent. #44. St. Paul: University of Minnesota, 1975.
- Portman, R. W. *Toxicity of Insecticides to Insect Pollinators*. Idaho Current Information Series, #184. Agri. Experiment Station. University of Idaho, 1972.
- Shaw, F. R. "Bee Poisoning: Review of the More Important Literature." *Journal Economic Entomology* 34: 45-6, 1941.
- Stanger, W. *Why and How Honey Bees Should Be Protected*. Agri. Ext. AXT-268. Davis: University of California, 1972.

POLLINATION

- Beekeeping by Orchardists in Central Washington*. Coop. Ext. Ser. #EM 2607. Pullman: Washington State University, 1975.

- Conner, L. J. *Bee Pollination of Crops in Ohio*. Coop. Ext. Bull. #559. Columbus: Ohio State University, 1973.
- Dorr, J., and Martin, E. C. *Pollination Studies on the Highbush Blueberry*. Reprint from Quarterly Bull., Michigan Agri. Experimental Station, 48(3). East Lansing: Michigan State University, 1966.
- Dyce, E. J. *Honeybees and the Pollination Problem*. Coop. Ext. Ser. Ithaca: Cornell University, 1960.
- Free, J. B. *Insect Pollination of Crops*. New York: Academy Press, 1970.
- Get More Fruit with Honey Bee Pollinators*. Coop. Ext. Ser. Insect Answers #EM 2922. Pullman: Washington State University, 1973.
- Honey Bees and Alfalfa Seed Production in Eastern Washington*. Coop. Ext. Ser. #EM 3475. Pullman: Washington State University, 1974.
- Increase Cranberry Production*. Coop. Ext. Ser. #EM 3468. Pullman: Washington State University, 1974.
- McGregor, S. E. *Insect Pollination of Cultivated Crop Plants*. Agri. Handbook #496. Washington, D. C.: Agri. Res. Ser. USDA, 1976.
- Martin, E. C. *Pollination of Fruit Crops*. Dept. of Ent. Mimeo. East Lansing: Michigan State University.
- *The Bountiful Business of Bees*. Agri. Experimental Station, Science in Action. East Lansing: Michigan State University, 1970.
- and Collison, C. *Honey Bee Pollination of Pickling Cucumbers: Theory and Practice*. Dept. of Ent. Mimeo. East Lansing: Michigan State University, 1970.
- Meeuse, B. J. D. *The Story of Pollination*. New York: Ronald Press, 1961.
- Newton, D. C. *Bee Notes for Orchardists*. New Britain: Central Connecticut College, 1974.
- Pollination and the Honey Bee*. Ext. Ser.

#1112. Washington, D. C.: GPO, USDA, 1975.

- Smith, M. V. *Pollination for Fruit and Seed Production*. AGDEX 616. Ontario Ministry of Agriculture and Food. Guelph: University of Guelph, 1972.
- Stanger, W., and Thorp, R. W. *Honey Bees in Almond Pollination*. One Sheet Answer #196. Davis: University of California, 1973.
- *Cantaloupe, Cucumbers and Watermelon Pollination*. One Sheet Answer #231. Davis: University of California, 1972.
- Using Honey Bees to Pollinate Crops*. USDA Leaflet #549. Washington, D. C.: GPO, 1968.
- Zozaya, Rubio, J. A. "The Importance of Apiculture in Food Production" In VIII *Inter-American Meeting on Foot-and-Mouth Disease and Zoonoses Control*. (316): 64-68. Washington, D. C.: Pan American Health Organization, Science Publication, 1976.

PRODUCTS OF THE HIVE
(EXCLUDING HONEY)

- Banks, B. E., Hanson, J. M., and Sinclair, N. M. "The Isolation and Identification of Noradrenaline and Dopamine from the Venom of the Honey Bee, *Apis Mellifera*." *Toxicon* 14(2): 117-125, 1976.
- Beck, B. F. *Bee Venom Therapy*. New York: D. Appleton-Century, 1935.
- Beeswax from the Apiary*. Advisory Leaflet #347. Edinburgh, Scotland: HMSO Press, Min. of Ag., 1971.
- Broadman, J., M. D. *Bee Venom*. New York: Putnam and Sons, 1962.
- Hocking, B., and Matsumura, F. "Bee Brood and Food." *Bee World* 41(5): 113-120, 1960.
- Jane, S. K., and Bumba, Y. "Composition of Bee Glue (Propolis)." *Pharmazie* 29(8):

544-545, August 1974.

Maksimenko, P. T., and Kozdoba, A. A. "Allergic Reaction to Propolis (Bee Glue)." *Stomatologiya* (Mosk) 54(6): 67-69, November-December 1975.

Psakhis, B. I., and Volgina, M. E. "Use of Inhalation Aerosols of Propolis for the Treatment of Acute Inflammatory Disorders of the Upper Portion of the Respiratory System." *Zh. Ushn. nos Gorl. Bolezn.* (2): 92-93, March-April 1976.

Root, H. H. *Beeswax*. Brooklyn: Chemical Publishing Co., 1951.

Royal Jelly. Agri. Res. Ser. #CA 33-19. Washington, D. C.: USDA, 1962.

Soffer, A. "Chihuahuas and Laetrile, Chelation Therapy, and Honey From Boulder, Colorado." Editorial. *Arch. Intern. Med.* 136 (8): 865-866, August 1976.

QUEENS

Doolittle, G. M. *Scientific Queen Rearing*. Hamilton, Illinois: Amer. Bee Journal, 1888.

Harp, E. P. *A Method of Holding Large Numbers of Honey Bee Queens in Laying Condition*. Ent. Res. Div., Agri. Res. Ser. Madison: University of Wisconsin, 1969.

— *A Specialized System for Multiple Rearing of Quality Honey Bee Queens*. Bee Management Lab., Agri. Res. Serv., USDA. Madison: University of Wisconsin, 1973.

— *Storage of Queen Bees*. Ent. Res. Div. USDA. Madison: University of Wisconsin, 1967.

Instrumental Insemination of Queen Bees. Agri. Handbook #390. USDA. Washington, D. C.: GPO, 1970.

Johansson, T. S. K., and Johansen, M. D. *Queen Introduction*. Flushing, New York: City University, 1971.

Laidlaw, H. H. *Instrumental Insemination of Honey Bee Queens*. Hamilton, Illinois: Dadant and Sons, Inc.

Laidlaw, H. H. and Edkert, J. E. *Queen Rearing*. Berkeley: University of California Press, 1962.

Pellett, F. C. *Practical Queen Rearing*. Quincy, Illinois: Jost and Kieker.

SCHOOLS AND COURSES

Agricultural Technical Institute, Two-year Technical Beekeeping Degree. Ohio State University Technical Institute, Wooster, Ohio 44691

Courses

Cornell University, Apiculture, Comstock Hall, Ithaca, New York
University of Illinois, Coop. Ext., 122 Mumford Hall, Urbana-Champaign, Illinois 61801
Pennsylvania State University, College of Agri. Ext. Ser., University Park, Pennsylvania

SUPPLIES, FOREIGN

Chr. Graze K. G. 7057 Endersbach bei, Stuttgart, Germany

Lee's Bee Hive Works. George St., Uxbridge, Middlesex, England

Taylor's of Welwyn. E. H. Taylor Ltd., Welwyn, Herts. AL6 OAZ England

Thorne's. E. H. Thorne, Wragby, Lincolnshire, England

SUPPLIES, U.S.

Dadant & Sons, Inc., Hamilton, Illinois 62341

Diamond Match Co., Chico, California 95926

Hubbard Apiaries, Onstead, Michigan 49265

Hutchison Mfg. Co., Redlands, California 92373

Walter T. Kelley Co., Clarkson, Kentucky 42726

Lastrange's, Ware, Massachusetts 01082

Leahy Mfg. Co., Higginsville, Missouri 64037

August Lotz Co., Boyd, Wisconsin 54726

Marshfield Mfg. Co., Inc., Marshfield, Wisconsin 54449

Maxant Industries, Inc., P. O. Box 454, Ayer, Massachusetts 01432

The Mid-Western Hive Co., 1527 E. 26 St., Minneapolis, Minnesota 55404

A. I. Root Co., Medina, Ohio 44256

Nieman's Bee Supplies, 23848 SE 216, Maple Valley, Washington 98039

Parowan Honey Co., Inc., P. O. Box 305, Parowan, Utah 84761

Sandt's Honey Co., 714 Wagener Ln., Easton, Pennsylvania 18042

Stony's Bee Supplies, P. O. Box 212, Homer-ville, Georgia 31634

Superior Honey Co., Southgate, California 90280 or Ogden, Utah 84401 or Denver, Colorado 80202

Williams Bros. Mfg. Co., Portland, Oregon 97208

Also:
Montgomery Ward
Sears

TEXTS

Barth, W., Ed. *Five Hundred Answers to Bee Questions*. Median, Ohio: A. I. Root Co., 1955.

— *Starting Right with Bees*. Medina, Ohio: A. I. Root Co., 1956.

Dadant, C. P. *First Lessons in Beekeeping*. Hamilton, Illinois: Amer. Bee Journal, 1952.

Eckert, J. E., and Shaw, F. R. *Beekeeping*. New York: MacMillan, 1960.

Grout, R. A. *The Hive and the Honeybee*. Hamilton, Illinois: Dadant and Sons, Inc., 1963.

The Hive and the Honey Bee, edited by Dadant & Sons. Hamilton, Illinois: Dadant and Sons, Inc., 1975.

- Kelley, W. T. *How to Keep Bees and Sell Honey*. Clarkson, Kentucky: Walter T. Kelley Co., 1966.
- Morse, R. A. *Bees and Beekeeping*. Ithaca: Cornell University Press, 1975.
- *The Complete Guide to Beekeeping*. New York: Dutton, 1972.
- Root, A. I. *The ABC and XYZ of Bee Culture*. 36 ed. Medina, Ohio: A. I. Root Co., 1975.
- Taylor, R. *The How-to-do-it Book of Beekeeping*. Naples, New York: Walnut Press, 1974.
- *Joys of Beekeeping*. New York: St. Martin Press, 1974.

USDA BEE LABS

- Arizona: Bee Research Lab, Agri. Res. Service,
2000 East Allen Road, Tucson, Arizona 85721
- Louisiana: Bee Breeding Lab, RR 3, Box 82-B,
Ben Hur Road, Baton Rouge, Louisiana 70808
- Maryland: Bioenvironmental Bee Lab, Bldg. 476,
Agri. Res. Center, Beltsville, Maryland 20705
- Utah: Wild Bee Research Lab, UMC 53, Room
261, Utah State University, Logan, Utah
84322
- Wisconsin: Bee Management Lab, Room 436,
Russell Labs, University of Wisconsin,
Madison, Wisconsin 53706
- Wyoming: Pesticides/Bee Disease Lab, University
Station, P.O. Box 3168, Laramie, Wyoming
82071

Index

- Abdomen, 5**
Absconding, 74
Acarine disease, 101
Acid board. See Fume board
AFB. See American Foulbrood
Africanized Kerr strain, 4
Air flow in hive, 55
Alarm pheromone, 14, 16, 31, 36, 114
Allergy to bee venom, 2, 112
American foulbrood, 2, 63, 106-108
 in commercial honey, 49-50
Anatomy of bee, 5, 114
 See also names of individual body parts
Antennae, 114
Apiary. See also Colonies
 enlarging, 28-29
 locating, 24
Apiary Inspection Law, 2
Apis mellifera, 4
Asthma, and bee sting, 113
Attraction pheromone, 41, 173
- Balling, of queen, 37, 38**
Bears. See Pests
Bee blower, 63
Bee brush, 61
Bee escape, 19, 23, 61
Bee gloves, 22
Bee hive. See Hive
Bee smoker, 23
Bee space, 14
Bee sting. See Sting
Bees
 introduced to Western hemisphere, 4
 leasing, 109
 obtaining, 28-29
 races of, 4
Beeswax. See Wax
Beginner's list of equipment, 21
Behavior of bees, general, 7-17
 See also Management
Benton cage. See Requeening
Birds. See Pests
- Boardman feeder, 48**
Bombidae family, 7
Bottom board, 20
Branding hives, 18
Brood, commercial use, 98
Brood diseases, 22, 50, 105-108
Brood nest, 7, 34
Brood pattern, 12
Burr comb, 34
- Candy. See Feeding**
Cappings
 of brood, 12
 as hive product, 97
Carniolan bees, 4
Caucasian bees, 4
Cellar wintering, 67
Chalkbrood, 105
Chantry cage. See Requeening
Chemicals for fume board, 62
Chemotherapy, 108
Classification of bees, 3
Cleansing flight, 16, 64
Clipped queen, 71-72
Cluster
 swarm, 73
 winter, 64
Cobana comb honey, 60
Colonies
 how many to have, 22
 transporting, 2
 uniting, 68
Colony
 estimating size, 55
 life within, 7-17
 temper of, 35
Colors seen by bees, 115
Color system. See Queen marking
Comb
 building, 12
 drawn, 20
 as feeder, 48, 51
 sterilizing, 102
- Comb honey, 60**
Commercial use of hive products, 97-98
Communication among bees, 16
Congestion of colony, 75
Cost of beginning, 21
Creosote, 20
Crops pollinated by bees, 110
Crossbreeding, 4
Cut-comb honey, 60
- Dance communication, 16**
Dark bees, 4
Defense of colony, 16
Demaree method. See Swarm control
Diary, hive, 31
Disease, 101. See also names of specific diseases
 of adult bee, 102-105
 of brood, 105-108
Division-board feeder, 45
Doolittle method. See Queen rearing
Drift, 76
 prevention, 26
Drone, 11
 congregating areas, 9, 11
 layer, 11, 12, 83
Drone cell, 11, 12
Dwindling, 55
Dyce process. See Granulation of honey
Dysentary, 53, 102
- EFB. See European foulbrood**
Egg, 7
Entrance cleat, 20, 64
Equipment
 beginner's list, 21
 to take to apiary, 31
 used, 22
Escape board, 61
Ethylene oxide chamber, 22, 108
European bees, 5
European foulbrood, 63, 105-106
 in commercial honey, 49-50

- Eusocial community, 3
 Evolution
 of bees, 4
 of insect societies, 3
 Examination of colony, 30-37
 Extractor, 94
 Eyes of bees, 115
- Fall management. *See* Management
 Fanning, 14
 in swarm, 73
 Federal Indemnity Program, 105
 Feeders, 45-48
 Feeding, 44-52
 package bees, 39
 when, 44
 winter, 65
 Fermentation of honey, 94
 Festooning, 13
 Flights, types of, 16
 Follower boards, 20, 66
 Fondant. *See* Feeding
 Food exchange, 14
 Foraging, 12, 16
 Foulbrood spores, 49
 Foundation, 20-21
 Frames 20
 Friction pail feeder, 45
 Von Frisch, Karl, 16
 Fuel for smoker, 32
 Fume board, 61
 Fumidil-B, 102, 108
 Fumigation, 101
 for foulbrood, 107-108
 for nosema, 102
- Galleria melonella. *See* Wax moth
 Genetic traits of bees, 10
 Gloves, 22
 Granulation of honey, 95
 Guard bees, 14, 31
- Hayfever, and bee sting, 113
 Heat, generated by bees, 64
 Hive, 2. *See also* Apiary; Colonies
 branding, 18
 double-walled, 67
 examining, 33-37
 insulating, 65
 parts, 18-21
 population, 7
 estimating, 55
- Hive
 spacing, 26
 weight, 25
 Hive diary, 31
 Hive duties of bees, 12
 Hive heater, 67
 Hive odor, 13
 Hive products, 25
 Hive scale, 25
 Hive stand, 20, 25-26
 Hive staples, 70
 Hive tool, 23
 Honey, 93-96
 commercial forms, 60, 93
 as larval food, 7
 natural fermentation of, 63, 94
 winter stores for bees, 60, 63
 yield per colony, 60
 Honey crops, 60
 Honey flow, 55-56
 Honey house, 93
 Honey plants, 109
 Honey sac, 114
 Honey super, 20
 Honey Bee Act, 101
 Honeydew, 25, 109
 Hybrid bees, 4
 varieties, 3
 Hymenoptera, 7
 Hypopharyngeal glands, 7
- Immunity to bee sting, 2, 112
 Importing bees, 4, 101
 Increases, making, 76
 Indemnity. *See* Federal Indemnity Program
 Inner cover, 19, 61
 as feeder, 48
 Insects
 communities, 3
 enemies of bees, 101
 pollinators, 3
 Insecticides. *See* Pesticide poisoning
 Inspection for foulbrood, 2
 Insulating hives, 66
 Italian bees, 4
- Jar feeder, 45
- Kerr. *See* Africanized Kerr strain
 Killer bees. *See* Africanized Kerr Strain
- Lancet, 7
 Langstroth, L. L., 14
- Larvae, 7
 Laying worker, 11, 72, 83
 Leasing bees, 109
 Legal aspects of beekeeping, 2, 69, 108
 Lifting supers, 63
- Management
 fall, 63
 spring, 25, 53-55
 summer, 55-63
 winter, 53, 63-67
 Mast cells, 112
 Mating flight, 9-10
 Medicating bees, 39, 63
 swarm, 29, 81
 Medication
 for bee sting, 36
 for diseases of bees, 102, 108
 See also names of bee diseases
- Mice. *See* Pests
 Midnite bees, 4
 Miller feeder, 45
 Miller method, supering, 60
 See also Queen rearing
 Moving bees, 69-71
 Mraz bees, 4
- Nassanoff gland. *See* Scent gland
 Nectar, 93
 Nest cleaning, 14
 Nosema, 53, 63, 82, 102
 Nuc. *See* Nucleus hive
 Nuc box, 70, 80
 Nucleus hive, 28
- Observation hive, 118
 Orientation
 flight, 16
 pheromone, 115
 Outer cover, 19
 Outyard, 25
- Package bees, 28, 38-44
 Parthenogenesis, 10
 Pest strip, 101
 Pesticide poisoning, 103-105
 Pests, 99-100
 preventing infestation, 26
 Pheromone: 114
 See also Alarm pheromone; Attraction
 pheromone; Queen pheromone; Worker
 pheromone

- Plastic hive parts, 18, 20
 Poisonous plants, 100
 Pollen, 50
 commercial use, 98
 as adult bee food, 50-52
 as larval food, 7
 Pollen basket, 51
 Pollen-collecting structures, 115
 Pollen extenders, 52
 Pollen plants, 109
 Pollen supplement, 52
 Pollen trapping, 50
 Pollination, 109
 Pollinators, 3
 Porter bee escape, 61
 Preservatives for hive parts, 20
 Propolis, 14, 98
 removing from clothing, 22
 Protective clothing, 22
 Pupal stage, 8
 Push-in cage. *See* Requeening
- Queen, 9-10
 balling, 37, 38
 clipping, 71-72, 74
 genetic characteristics, 10
 introducing, 85-89
 lifespan, 83
 locating, 35
 in aggressive hive, 88
 marking, 71-72
 mating flight, 9-10
 use of sting, 36
 Queen cells, 9, 73, 74, 82, 91
 Queen excluder, 20
 Queen pheromone, 5, 9, 14, 74, 114
 in supersedure, 82
 in swarming, 74
 Queen rearing, 89-90
 Queen substance. *See* Queen pheromone
 Queenright colony, 12
 Queens, sources, 83
- Races of bees, 4-5
 Records, 27
 See also Hive diary
 Registering hive, 2
 Requeening, 83-89
 Reverse supering, 56, 75
 Rim feeder, 49
 Robbing, 16
 Round dance, 16
- Royal jelly, 7, 9, 50, 83
 commercial use, 98
- Scale, 25
 Scent gland, 15, 73, 114
 Scenting, 41, 115
 Seasonal management. *See* Management
 Section honey, 60
 Septicemia, 103
 Skunks. *See* Pests
 Smoker, 23, 31-32
 Smoking bees, 31-32, 41
 Social insects, 3
 Sodium sulfathiazole, 108
 Solar wax melter, 97
 Spermatheca, 10
 Spiracle, 5
 Spring dwindling, 55
 Spring management. *See* Management
 Starline, 4
 Sterilizing equipment, 22, 108
 Sting, 5, 7, 112-113, 36-37
 reactions and treatment, 36-37
 physiology, 112-113
 Stinging insects, 7, 36
 Stinging
 avoidance by protective clothing, 22
 means of defense, 16
 mechanism, 7
 of queen, 36
 Stomach mouth, 114
 Stroller spacers, 20
 Sugar, as bee food, 48
 Sugar syrup, 45-48
 in medicating bees, 81, 108
 in requeening, 85
 scented, 86
 as winter feed, 65
 Sulfa. *See* Sodium sulfathiazole
 Summer management. *See* Management
 Supering, 56-60
 Supers, 20, 25, 56
 lifting, 63
 Supersedure, 9, 82
 Swarm
 capturing, 29, 80, 81
 temper of, 73
 Swarm cells, 82
 Swarm control, 75-79
 Swarm trap, 80
 Swarming, 73-77, 83
 Syrup. *See* Sugar syrup
- Telescoping cover, 19
 Temper
 of bees, 35
 requeening, to improve, 88
 of swarm, 73
 Temperature
 control by bees, 14
 of winter cluster, 64
 Terramycin, 108
 Top supering, 56
 Two-queen system, 91-92
- Uncapping knife, 63
- Vandals. *See* Pests
 Veil, 22
 Venom, 7, 98
 allergy to, 2, 112
 collecting, 98
 commercial use, 98
 of stinging insects, 7
 Ventilation, 14
 for captured swarm, 81
 staggering supers, 93
 in winter, 62
 See also Fanning
 Vespidae family, 7
 Vision of bee, 115
- Wag-tail dance, 16
 Washboard movement, 14
 Wax, 12-13, 97
 cappings, 97
 Wax foundation. *See* Foundation
 Wax moth, 101
 Wax secreting glands, 5
 Weather
 effect on supersedure, 82
 effect on swarming, 74
 effect on use of fume board, 62
 Weight of colony, 25
 "Wet" frames, 49, 94
 Windbreaks, 65
 Wings, 5
 Winter cluster, 64
 Winter management. *See* Management
 Worker, 7-8
 duties, 12-17
 laying, 11, 72, 83
 Worker pheromone, 15, 114
 Wrapping hives, 65
 Yeasts in honey, 63