

Troubled Times



Energy



Click on the icons above to go to your area of interest.



Troubled Times



TOPIC: Windmills

[Windmills](#) act as a pollution free power source that is nearly as cost effective as conventional sources. Efficiency must be increased to support [Hydroponics](#). Innovative windmill designs such as the low wind [Satec](#) or low priced [Saronan](#) or the wind turbine [EcoQuest](#) are coming on the market. For information consult windmill manufacturers, the American [Wind Energy Association](#) and their [Archives](#), [Small Turbine](#) resources, or sources such as [Bergey Windpower](#), Whisper Generators which offers [Small/Portable](#) windmills, or [Home Power](#) magazine, or [Wind Power](#) sites. A number of [Portable](#) windmill options exist. Placement in order to [Catch the Wind](#) or having a [Wind Focus](#) is also important, as are factors such as [Wind Speed](#) and blade size. [Tilt-up Towers](#) provide flexibility, as [De-Mounting](#) is necessary in [High Wind](#). Information on the wind energy potential within the US is available, and being [Promoted](#) by the DOE. [People Power](#) and windpower for [Communities](#) is the trend in Europe. [High Winds](#) can cause problems unless a [Brake or Lock](#) or [Mount/Dismount](#) mechanism is in place. [Ice](#) in winter is also a concern. [Cost](#), choice of [2 or 3 Blades](#), size and weight options such as a [20 kW](#) output mill, the availability of [Replacement Parts](#) are all factors in the [Make or Buy](#) decision, and [Windstream Power](#) provides details. [Used Windmills](#) are available.

Troubled Times



TOPIC: Home Made

[Make Shift](#) windmills could be made from [Existing Technology](#). [Car Parts](#) could be used to construct a [Paddle Wheel](#) windmill, using such parts as the [Generator](#), [Water Pump](#), and [Tire Rim](#). [Axle Paddles](#) using a [12V Series](#) can be used, as has been suggested by [VITA](#) and done with a [Model T Ford](#). Variations are a [Tire Prop](#), or an [Axle Prop](#) using [Axle Math](#) with great [Results](#), or a [Horizontal](#) windmill. Quite [Doable](#) as the [Savonius Rotor](#) demonstrates. [Lawn Mower](#) blades could form a windmill. A [Wind Gauge](#) can be constructed, as can [Battery Charging](#) controls such as a [Voltage Regulator](#). [Battery Banks](#) need to [Stay Charged](#). [Generators](#) such as the [Servo Motor](#) are available. Plans for a build-your-own [Wind Generator](#) or [Alternator](#) exist, can be a converted [Aircraft](#) or [Lawnmower](#) generator, and [Books](#) or a [Turbine Design](#) site or other [Web Sites](#) can help. Plans for a [Woodcrafted](#) windmill exist. [Blade Design](#) is explained. A [Downwind](#) generator gets less stress, as an [Overdriven](#) generator will burn out, as will an [Alternator](#), and [Balance](#) counts. [Old Fashioned](#) plans are also available for mills such as the [Nebraska Windmill](#), which can be built using [Sails](#) and operates at [Ground Level](#) as this [Sketch](#) shows, which can present [Problems](#). A dedicated Troubled Times member from Sweden has provided a [Home Made](#) wind turbine design and outlined the [Factors to Consider](#), specifying the [Supplies Needed](#), how to calculate the [Wing Diameter](#), how to calculate the [Natural Force](#) of the wind and expected [Output](#), how to calculate the [Wing Width](#) and a wing [Width Example](#), how to calculate a [Wing Profile](#) with NACA points and a [Profile Example](#). A Troubled Times [TEAM](#) has been formed to find inexpensive ways to build windmills.

Troubled Times



Pelton Wheel

Hydro Electric Power

ADVANTAGES

- Can be more cost effective than either solar or wind power.
- Costs approximately one tenth as much as solar systems of similar power.
- More consistent continuity of supply (24 hours a day rather than just daylight hours).
- Need for large battery banks can be alleviated through intelligent water catchment and slow release over a long period.

THERE ARE FOUR TYPES OF HYDRO SYSTEMS

High Head Turbines

The Turgo and Pelton Wheel are impulse turbines which use a high head to extract a greater potential energy from the same amount of water. Dependent on a fall of more than 20 meters, they need a relatively small flow rate, the water being piped down to the turbine to create the required head (pressure).

Medium Head Reaction Turbines

With a lower head, greater volume is required to produce the same amount of power. The Francis turbine is a medium head turbine ideal for small scale applications.

Low Head Turbines

These systems require a much larger volume of water to generate a useful amount of power. They are therefore more limited to locations in or on the edge of a stream or creek. A Kaplan propeller is an example of a low head turbine.

Flow of Stream Turbines

Gear pumps can be used as turbines. Although they have high frictional and leakage losses, they are otherwise suitable for small scale hydro power applications. Gear pumps used as turbines need a medium to high head.

Banki (cross flow) turbines can be used for heads as low as 1 metre, up to heads as high as 200 metres. They can be manufactured in the back yard workshop and are good for small scale hydro power applications. A banki is in fact a two stage turbine. Where there is a fast flowing stream but virtually no head a floating propellor driven turbine may be used.

The **Tyson Turbine** is ideally suited for such situations. The Tyson is suspended in the water by two pontoons, tethered to the banks, bridge or pier by means of a steel cable. The flow of the river rotates the submerged turbine head which is attached to a right angle gear box. This transmits the power above water level to an electric generator via a pulley. This system can generate low voltage DC for charging batteries or higher voltages to transmit power up to 5 kilometres in distance. Power can be unregulated AC which is transformed and rectified to low voltage DC where required. Outputs up to 1500W can be generated depending on water flow rate. Power generation and water pumping

can be performed simultaneously. Power output (depending on water flow): 130 amps at 12v or 65 amps at 24v using automotive alternator or permanent magnet DC generator.

WHERE CAN I GET THESE SYSTEMS?

The Rainbow Power Company of Nimbin Australia are recognised both in Australia and internationally for their expertise in renewable energy production systems and particularly for their hydro systems. The **Rainbow Micro Hydro** is the result of 20 years of experience in the field, incorporating state of the art design and materials. It is a low maintenance system with an exceptional service life. Installation is simple and requires no special skills. It is easily integrated into any battery centred electrical system.

Power output is exceptional for a micro hydro unit. It will produce 20 amps (12v) with a head pressure of 13 metres and 7 litres per second flow rate. With a greater head, less flow rate is required to produce the same performance. More to follow in future updates. In the meantime, contact

Rainbow Power Company

Tel: +61 66 89 1430

Fax: +61 66 89 1430

The Pelton Wheel and other earth friendly technologies are carried by:

QDC Solutions

Phone: +61 66 841100

Fax: +61 66 843600

PO Box 875

Mullumbimby NSW 2482



Troubled Times



TOPIC: Hydroelectric

When one [Compares Costs](#) of hydroelectric power to other off-the-grid electric sources such as solar power or gasoline generators, hydroelectric power is quite inexpensive! A Troubled Times member has worked up the requirements for a [Model System](#), and calculated the costs for a [Micro-Hydro](#) Installation. There is a [Cost Range](#) between small and large systems. If one lives near a small mountain stream, a [High Head](#) system can take advantage of the altitude drop. The altitude drop can also [Pump Water](#) through simple mechanical means. The ram pump can pump [Standing Water](#) uphill with no power required. Even a small stream can generate power with an [Aquagen](#). Components for hydroelectric systems can be [Purchased](#), and one can even build their own [Ram Pump](#) with a [Back-to-Basics](#) approach. Even the tide can be captured to create hydroelectric energy, as [Blue Energy](#) explains! A low power output can be [Boosted](#).

Troubled Times



TOPIC: Coal and Coal Gas

There is a long tradition of using coal for heat and light in many places around the world. In the UK whole communities have lived for centuries around the coal based energy principle. Where petroleum may ignite and disburse during a pole shift, coal will be available during the Aftertime. It makes a lot of sense to use coal, plus there is a simple method to extract gas suitable for lighting from coal (and dry wood). [Coal Gasification](#), as described, is a simple enough method that something akin to petroleum can be achieved, as a Troubled Times member recalls this was called [Producer Gas](#) in Australia during WWII.

Troubled Times



TOPIC: Alternatives?

Practical off-the-shelf products for [Alternative Energy](#), [Independent Power](#), or [Home Power](#) such as hydroelectric or wind generated electricity and storage batteries are available. There are a few simple [Basics](#) and [Components](#) to keep in mind. [Thermo-Electric](#) power generation is affordable, and [Nuclear Plants](#) available. A method of generating electricity from the [Earth's Motion](#) has been patented, and a [Flywheel](#) may work. Heat from [Waste Water](#) can power appliances, and from [Geothermal](#) can distill water. The jury is still out on [Fuel Cells](#), and [Portable Generators](#) are under development. Fuel from [Algae Hydrogen](#) production is possible, though [Hydrogen](#) is dangerous. [Robots](#) can run on meat and even [Electric Eels](#) and [Photosynthesis](#) have potential, as do [ElectroMagnetic](#) generation and [Magnets](#). Energy that is [Sustainable](#) is the key. The [DOE](#) has multiple tips and links, as do [Jade Mountain](#), [Home Power](#), and the [Alt Energy Store](#). [Mr. Solar's](#) advice on simple energy solutions such as the Pelton Wheel are documented among his articles on [Hydroelectric Generation](#). Check his online [Catalog](#) of solutions.

Troubled Times



TOPIC: Carbon Arc

A quick glance into the recent past shows the [History](#) of Carbon Arc included using them as [Street Lights](#) in the streets of London and Paris. The light from Carbon Arc is equivalent to sunlight, and is extremely [Bright](#), [UV Intensive](#)! At start-up the rods need to be in contact with each other, then pulled apart to create the arc. Because Carbon Arc consumes the carbon rods, for continuous operation over many hours a [Mechanism](#) needs to be in place to move the rods toward each other, steadily, using [Solenoids](#) which adjust per the voltage. Carbon Arc rods last longer if [Enclosed in Glass](#), by an 80/1 margin. Carbon Arc is in essence a lost art, but the concept remains the same, and is often [Child's Play](#), a childhood experiment. A Troubled Times member [Constructed](#) an arc at home but found [Making the Rods](#) requires a [Manufacturing](#) process, not easily done as this [Carbon Black](#) process describes. Thus, using old [Battery Cores](#) is the immediate solution! Carbon Arc is also uses a lot of electric current, another [Consumption](#) problem. Carbon Arc parts can be [Purchased](#), some manufactured, some from old stock.

Troubled Times



TOPIC: Inverters

There are [Pros and Cons](#) in using either AC or DC current in the Aftertime, or [Both](#), but DC has [Simplicity](#) and requires [Less Maintenance](#). Even devices such as computers and [Monitors](#) can and do run on DC at 12V, but there are [Exceptions](#). However, DC current can't travel long distances so the source must be in [Close Proximity](#) to the application. AC alternatively requires a [Steady Source](#) and [AC Generators](#) are thus tricky, but many devices have high [Startup Current](#) requirements which AC provides. [Inverters](#) can be purchased from many sources, but [Switching](#) between DC/AC creates power loss, and the right [Inverter Choice](#) saves power. A [Step Up](#) converter can then boost to 220 AC, and a [Auto Alternator](#) can be used in this manner. To use a [3 Phase](#) induction motor to convert DC to AC, perform a [Bench Test](#) on a [DC Generator](#), then keep [2% Above Sync](#) to prevent [Brownout](#) and maintaining a proper [Slip Speed Ratio](#). A [UPS](#) can help prevent brownout too. Computer [Reel to Reel](#) motors can also be used to convert DC to AC, where [Voltage](#), [AMPs](#), and the [RPM](#) generated are variables. A [Low RPM](#) alternator can be constructed.

Troubled Times

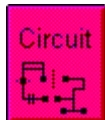

TOPIC: Circuitry

Dedicated Troubled Times members define [Chips vs Valves](#), [Transistors](#), [Electron Flow](#), [Amps](#), and [Alternators vs Generators](#). The importance of [Wire Size](#) should not be underestimated. With a simple [Universal Bracket](#) one can build a generator. Generators need to be sized for the [Load](#) they will carry, and generator [Features](#) vary. The ability of [Semiconductors](#) vs [Valve Based](#) technology to withstand a pole shift differs. [Magnets](#) can be constructed. An [Induction Motor](#) can be converted to a generator for a grid powered by [Wind or Water](#). [Scoraig](#) generator building plans are free!

Troubled Times



TOPIC: Illumination

The Aftertime will be [Gloomy](#), unable to meet the [Requirements](#) for [Full Spectrum](#) and [Blue Light](#) needed for [Health](#) and [Photosynthesis](#). Achieving this indoors requires [Planning](#), as [Too Much](#) light, the [Wrong Spectrum](#), or low [Intensity](#) matter. Indoor [Gardening](#) factors are [Hours/Day](#) of light, which can be increased with [Reflectors](#), and [Space/Person](#). The relative [Efficiency](#) of lighting methods should be considered. [Maximum Efficiency](#) of [Watts/Plant](#) can be calculated, as in examples for [Metal Halide](#) or [Street Lamps](#). [Reference Material](#) on these matters, including [Lux Meters](#), are available. The most durable and efficient [Light Bulbs](#) are [Halogen Quartz Lamps](#), car and truck headlights. Lighting varies by [Bulbs & Filters](#). Light bulbs and their [Filaments](#) will shatter during the pole shift earthquakes, and [Bulb Replacement](#) poses many problems and requires [Expertise](#), but can be [Home-Made](#)!

The ultimate answer to having a stock of common incandescent light bulbs [Last 100 Years](#) or more is [Low Voltage](#), the theory behind [Long-Life Bulbs](#) but [Fluorescent](#) bulbs cannot benefit from this.

Troubled Times



TOPIC: Sources

A Troubled Times member has constructed a [Long Lasting](#) flourescent tube using [Car Parts](#) and a [Parts List](#), with a [hV Connection](#) and a [Caution](#).

Troubled Times



TOPIC: LEDs

[LEDs](#) are [Feasible](#) as they are shatter-proof, long lasting, and can be a [Replacement](#) for other types of bulbs. There are full spectrum [Blue LEDs](#), as a [Red/Blue Balance](#) is necessary to grow plants, and [Cost Varies](#). For indoor gardens, [LED Arrays](#) would be used, but are still [Expensive](#), as [GELcore](#) exemplifies. [Led Clusters](#) are coming on the market, however, as well as new high intensity [LumiLEDs](#), and there are many LED [Sources](#). Instructions on [How to Wire](#) LED arrays are available, but there are basically [Three Methods](#). A [Lower Voltage](#) extends the life of LEDs, and an [Optimum Design](#) can be computed. [X-mass Tree](#) bulbs can be wired in series and have different [Characteristics](#) and [Optimal Curve](#). There are [Pro/Con](#) for LEDs vs X-mass tree lights. [LED Cost](#) compares well on a [Demo](#), and should be balanced by comparisons on [Lumens/Watt](#) output, long range costs due to [Life Span](#) of the bulbs, feasibility of [Other Sources](#) such as [Neon](#) or [Flourescent](#). A Troubled times [TEAM](#) has been formed to seek inexpensive LED array solutions. LED arrays such as the [Quantum Device](#) or [Delta Light](#) grow plants and are used by [NASA](#). Using LEDs for gardening could avoid [Battery Banks](#). Longlasting LED [Flashlights](#) are available. In a primitive environment, more light can be secured from a [Wide Angle](#) LED. Determine the [Resistor](#) and best [Battery Pack](#). LED [Lifetime](#) can be enhanced. LEDs can help when [Dealing with Bugs](#). LEDs in [Taillights](#) can be used, [Construction](#) detailed. Light bulbs can be replaced with LEDs, using the [Old Sockets](#). A LED [Task Light](#) can be constructed, with a [Clip-On](#) and a [Wide-Angle](#) lens.

Troubled Times



TOPIC: Electrical Devices

With careful planning, lights and even such complicated devices as [Computers](#) will be operational and repairable. Other devices can be [Modified for DC](#). A [UPC](#) can help! Understanding [How Things Work](#) can help.

Troubled Times



TOPIC: Rainbow

[Rainbow](#) Power Company of Australia sells renewable energy equipment, i.e.: solar panels, solar hot water heaters, wind generators and micro hydro generators. It also specializes in support products such as inverters, pumps, controllers, composting toilets and services such as training, system design and consultancy. The most unique facet of this operation is that the whole business is run entirely from its own 3.5KW photovoltaic array, 2KWs of wind generators and has a 2KW steam generator. Rainbow's goal is to offer the latest, most diverse range of products and services available in the alternative energy field in the World today. Already Rainbow Power Company exports up to 15% of its annual turnover to other countries that also require sustainable solutions to power generation.

Troubled Times



Wind Mills

An article called *Harnessing the Wind* on page 78 of the November, 1995 issue of *IEEE Spectrum* magazine describes how wind mills are successfully competing with traditional power sources around the world. The extensive and highly technical article, by Jay Jayadev of **R. Lynette & Associates**, gives case histories detailing wind mill installations in third world countries.

Only fairly recently has wind power been recognized as the one renewable energy source that will be economically viable in the near future. The **Electric Power Research Institute** (ERPI), in Palo Alto, Calif., which represents cooperative R&D interests of the U.S. utility industry, stated in a 1992 report: "Alone among the alternative energy technologies, wind power offers utilities with good wind resources, pollution free electricity that is nearly cost-competitive with today's conventional sources."

Since then, several wind power projects from Antarctica and Mexico to India and Indonesia have shown how practical its use can be. Not only is the power supply reliable and easily maintained, but it can also be more competitive in the long run than traditional, more heavily polluting alternatives.

In the case of either horizontal or vertical axis turbines, good-quality electricity can be generated by two methods. In the well-established approach, induction generators are connected to the grid, resulting in the turbine's being mechanically constrained to a very narrow speed range and therefore producing a constant-frequency output suitable for pumping power to the grid. That means when high velocities or gusts of wind try to speed up the rotation of the shaft, the extra torque must be absorbed by the drive train and the tower. This approach causes torsional stresses on the mechanical parts and also wastes wind energy (although often the pitch of the rotor blades can be changed to reduce stress during high winds).

A newer approach, made feasible by advances in power semiconductors, is to allow the turbine speed to vary and then eliminate the fluctuations in amplitude and frequency electronically. By letting the generator speed up during gusts and sustained high winds, this approach both increases the amount of electricity generated and reduces the stresses on the drivetrain.

In general, such technology as high-efficiency blades and generators, along with power electronics for variable-speed drives, has contributed to reducing the cost of wind energy. Wind turbines can produce electricity at \$0.05kWh at a good wind site, with an average wind speed of greater than 5 meters per second.

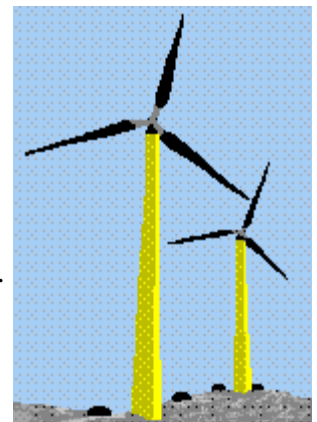

But in any situation, the fickleness of the wind must be considered. According to the **American Wind Energy Association**, most modern wind farms operate with a capacity factor of 25-35 percent - that is, the actual power produced over time as compared to the theoretical production of the turbines operating at maximum output 100 percent of the time. (Conventional power plants typically operate at 40-80 percent capacity factors.)

To supply villages with electricity, it is often more feasible to give them an independent source of power than to invest in transmission lines to connect them to the utility grid. ... Stand-alone installations are appropriate technologies for such applications. Because storage is a necessity in these isolated systems, they are technically more challenging to design and more expensive than are grid-connected generators that simply augment existing power infrastructures. To boost overall reliability of the electricity supply,

engineers can design systems that tie isolated wind machines to other types of generators. These hybrid systems often combine a wind turbine, a battery bank, and a diesel-powered backup generator.

Wind rotors in small turbines spin 100-300 or so revolutions per minute. Large turbines intended for grid interconnection spin about 30-60 revolutions a minute and sometimes even more slowly. In small systems, direct drive is preferred to geared drive for its higher reliability. Any standard off-the-shelf generator can be used with a speed-increasing gear, but reliability is reduced. As a result, manufacturers of small turbine systems develop their own custom generators, and couple them directly to the wind rotor. For example, in a machine developed by wind turbine manufacturer **Bergey Windpower Co.**, Norman, Okla., a permanent-magnet ring is directly attached to the wind rotor, which envelops and rotates about the station.

In designing stand-alone systems, engineers can choose from several options. Usually the systems operate in a variable-speed mode. To generate clean constant-amplitude, constant-frequency electricity, they therefore require a rectifier-inverter combination. For dc loads, of course, only the rectifier is needed. Generally, the average load is greater than 25 kW or so, using a single medium-sized turbine rather than several small ones is better - as long as the logistics are practical. For example, if a village requires 100 kW, and there is good access to the site, a medium-sized machine would be a good choice. Energy from these machines costs a half to a third of that from an array of small machines.

Small wind turbines usually have alternators with permanent magnet excitation. They produce power according to wind speed, reaching maximum power at 12 meters per second. Modern small wind machines have achieved a high level of integration and simplicity, and have proved that they can work well in the field under extreme conditions. Bergey Windpower, for example, integrates the rotor and the hub into one component and the stator and the main frame into another, thus reducing the number of parts and boosting reliability.



Troubled Times



Satec

I asked Satec some technical questions about their unique turbine design, and below is their response. Please bear in mind that as they say "funding is a problem". This is so true. throughout the world governments are more likely to help fund research on the improvements of proven wind technologies, where there is a great deal of production data and performance evaluations available. New ideas sometimes don't get the attention that they deserve. The venturii action of the sail system is however a very old concept. Used in persia before the birth of Christ.

Offered by [Jay](#).

Satec Pty Ltd wrote:

Dear Jay,

Thank you for your enquiry, we are still a research and development company at this stage. We have trialled a number of prototypes, however, we are not commercialised as we have had trouble getting financial support in our country. Australian politicians talk alot about renewable technologies but do relatively little. This may well be a universal condition, however, I know that in the USA much has and still is being done on the technology front. You may appreciate that because we haven't commercialised our product that we won't release statistics into the internet world. The main reason for this is that construction and fabrication technology changes the output efficiency of the turbine quite considerably. Also our turbine is able to have multilevel blade stacking configurations, which means output can vary by that alone. At the moment our smaller units are around 4 kw and trialled with various generators mostly from other turbine manufacturers. I have enclosed a bit more descriptive information and will keep you on our database to update you as stats are available on product.

Regards, Peter Jansson.

Satec Wind Turbine Research & Development Notes

Satec was derived from Sail Advantaged Technologies. The Sail System runs on its own monorail track and is completely independent of the verticle stack of turbine blades. The sail system works by redirecting incident wind into the turbine, creating lift at the opening between the primary and secondary sails. The sail system also shields the turbine from drag it would normally experience in it's counter or windward rotation . The low pressure area behind the sails also assists in wind flow displacement, a very crucial issue in performance.

One of the main features with the Satec turbine design is to allow and promote wind flow characteristics through the turbine. If too much wind is stopped by the turbines presence a pressure zone is created and wind impacting on this pressure zone diverts and so lessens the availability of the energy resource. By maintaining and preserving volumetric efficiency, more energy is available to the turbine in it's efficient operation. The Sail system also allows us to choose where the incident wind is directed. The position of wind pressure from the Sail system can be focused further toward the inner part of the turbine creating higher RPM and greater flow through. As well as this the Sail system contributes to providing an additional 60 degrees of front blade lift. Our turbine blades get lift as any curved surface does with wind passing over it at the right angle of incidence, this lift force is very significant and contributes highly to the torque output. The effect of a pressure zone together with turbulence problems is what conventional horizontal axis wind turbine manufacturers are finding is restricting their performance achievements. The Satec turbine has better pressure zone management and less turbulence. The torque characteristics are very high with this design of turbine and this is further compounded by the Sail System.

A number of venturii actions are employed within the operation of both the Sail system and the turbine blade configuration. The intentions are to maximise "flow through" characteristics and increase internal pressures at the center of the turbine. An indication of the turbines aerodynamic qualities is that in operation it is very quiet. The turbine blades make no audible noise at wind speeds between 3mtrs sec up to 9 mtrs sec. The framework supporting the turbine contributes to some wind noise after 9 mtrs sec, however, we are working to reduce these structure related wind noises and don't consider them in any way a problem. Energy delivery is available from 3 mtrs per second wind speed. A recent design concept may allow these turbines to be built to supply

250Kw - 500Kw which would place them with existing large Horizontal Axis Wind Turbines. Wind farm applications would then be quite feasible with much less noise than present turbines.



Troubled Times

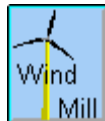

Saronan Power

Saronan Power is a wind generator in the 4-5Kw range for \$2500. I called them up to get details. The guy I talked to said he has not established production yet but is sending me some info.

Offered by [Steve](#).

Wind Generators to Cut Your Electric Bills

Saronan Power manufactures and sells roof mounted wind generators for electrical power. These units are small and light enough for residential as well as commercial use, and will typically generate four to five kilowatts with a 10 to 20 mph wind. Our money saving units are connected directly into your power breaker panel. They will reduce your electric bills! Of course, when the wind is not blowing hard enough to supply all of your power, your additional power needs are still supplied by your electric company. Units are \$2500, plus \$1000 if we install the unit. Instructions come with each unit so that you save more money by installing it yourself, a simple, half-day operation.

Saronan Power

938 E 14th Street
Colorado City, TX 79512
Phone: (915) 728-5553



Troubled Times

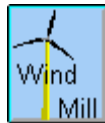

EcoQuest

Perhaps the most interesting device I saw at the wind power conference was a product that is not yet on the market, the [EcoQuest](#). Basically it is a wind turbine without the big awkward blades. It weighs about a hundred pounds and you can mount it on a rooftop with another one hundred fifty pound generator below in the house if I understand it right. A Google.com search for Ecoquest Windtree came up with several distributors planning to sell them, but the guy at the conference whose name is on the flyer is:

Jim Rabb
EcoQuest Distributor
P.O. Box 4344
Aurora, IL 60507
(630) 897-8978

Offered by [Steve](#).



Troubled Times



Small/Portable

Today I visited Southwest Windpower in Flagstaff, Arizona. They are the original makers of the Air 403, a 400W small wind turbine you could almost carry in your pocket. (13 lbs or < 6 kilos.) Last year they bought the company making the Whisper windmills. Their models are the H40 rated at 900W, the H80 at 1kW, and the larger 175 at 3kW. Small and portable windmills are ideal for survival groups that may need to move about. The H40 and H80s weighs about 30-32 kilos or 65-70 lbs, and retail for USD 1,500 to 2,790. The 175 needs to men carrying it, at about 70 kilos or 155 lbs, and it retails at USD 4,990. On their web site, they had only up to 45' towers last time I checked. They are however coming out with new towers on 70' and 84', retailing at USD 1,260 to 1,480, excluding the poles. 60" anchors run at USD 270 for a set of four.

As to current, the Whispers can only operate when charging a battery bank. For AC use, they do deliver a US inverter (110V, 60Hz). No European model as of yet. Interestingly enough, they have had requirements for a direct AC off-grid system without batteries, and are working on such a design. Personally, having left this idea behind, I believe using batteries will be the best way. I think Rolls is the leading battery maker. Their largest model is an incredible 2,000! Ah, but it is not really portable at 315 lbs or 145 kilos. Their 450 AH model may be a better choice, being somewhat more portable at approx. 75 lbs or 35 kilos (if memory serves me right).

Offered by [Jan](#).

Rolls make good batteries but there as expensive as hell. Try deep cycle golf cart batteries. You can find golf cart batteries anywhere in the world. They are cheap and a well known technology. Look in you phone book or ask at a golf course. You can also desulfate/recondition used batteries with the new chargers and some simple chemicals and that makes salvaging golf cart style batteries a good proposition post-pole shift.

Offered by [Ray](#).



Troubled Times

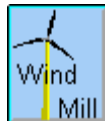

Home Power

I would *highly* recommend an excellent article in [Home Power](#), Issue 65, June/July 1998. It has both an excellent treatment of the basics of wind power for the layperson and ratings and information on each manufacturer. Very extensive and well done article and a good journal in general.

Offered by [Craig](#).



Troubled Times



Portable

I sent the following E-mail out to the AWH List (awea-wind-home@yahoogroups.com) one week ago. Below are some of the excellent responses I got. I think hugh's recommendations look the best. The first one in his list uses a prop that is about 20" in diameter. All recommendations I think would work.

Offered by [Mike](#).

Does anyone know where to purchase or how to make a lightweight portable windmill? Needs to produce enough electricity to recharge hand held ham radios, and LED flashlights for a party of 3 to 10. Estimate about 10 to 20 watt-hr over night (12 hr period) should be plenty for average wind conditions. Needs to be light enough to backpack it and supporting structure into primitive areas. Needs to be durable enough to work for extended periods of time. Needs to be relatively easy to put up. Assume average wind conditions without trees or above the trees. Assume one can choose to camp where the wind is blowing at least one out of each three-day period. Assume moving during the day, and near continuous cloudy rainy weather.

A lightweight hand crank generator could work as an alternative. This is, if the cranking time does not exceed say 10-20 min/day. Don't know what is available and which approach would be best. I am thinking if moving around a lot, the hand crank generator may be best. However, if camping in one spot for a while the windmill might be best. Any ideas on where to get these things and what will work best?

I don't know of anything quite that small on the market. There is the [Rutland 503](#), 3.5kg, and the [LVM A2](#), 5kg, Or you could use an [AIR](#), 6kg, or build one from the hub dynamo off a bicycle.

Hugh Piggott

I have an air 403. It is very light and has its own charge control built in. you might contact Southwest Wind Power and get the weight etc. Also LVM has a small genny without the furling tail but you would have to carry a charge control.

John Haymaker

Yes, Rutland makes a 36" blade one and 90 watts, a piece of cake to carry.

Mike Fournier

Take a look at [Trillium](#) A semi portable (meaning on a vehicle) version with a solar panel clamped to the side of a pole has been used in the UK for some time.

Bill Gray

Poweretek-Energeia is a very young company that produces hand crank generators.

-Attached we sent you two pictures of the generator.

-The estimated price for one unit is \$750 FOB Bogotá, for a number up to twelve units the price can be discussed.

-It is built in a very resistant material, non corrodible with common substances.

-The weight is 4.5 kg and the dimensions are 22.8x15.8x11.3 cms

-In a normal rate of work, 55-80 rpm at the hand crank, it delivers 25-35 Watts, It has a built in regulator/battery

-It is built as a simple box in order to adapt it to a bicycle or any other mechanical system.

-All moving parts are mounted on bearings

[Victor Robayo](#)

I suggest you to look at [Green](#) windmill plans.

József Huszti



Troubled Times

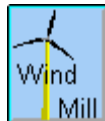

Catch the Wind

Research into the book *New Low Cost Energy Source for the Home* by Peter Clegg shows a meters to wind speed height ratio. Benefits are substantial going above 50 feet in height up to 76 feet in height above sea level. Above 76 feet the benefits are not significant. But a ridge placement is dramatically different. The whole lay of the land in how wind moves makes putting a mill at the top of a ridge far greater in performance than trying to get wind below it. In any case, there is always some wind at the 70 foot above ground level spot. This is the height you have to shoot for whether you're building a tower or going for a ridge placement.



Troubled Times

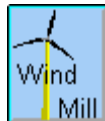

Wind Focus

Al Weisbrich of **Eneco Energy Systems** in Connecticut has a system for focusing the wind using jet engine turbines. It's all on paper. He says he's tested it, and he's done a number of papers, but there are no real world applications currently. Maybe you can be the first. 860-651-0061

Offered by [John](#).



Troubled Times



Wind Speed

The power generated from a windmill depends on both the wind speed and the size of the blades.

Wind Power Chart						
Output Rating	Blade	Kilowatt Hours at Various Wind Speeds				
(watts)	Diameter	8 mph	10 mph	12 mph	14 mph	16 mph
100	3	5	8	11	13	15
250	4	12	18	24	29	32
500	5	24	35	46	55	62
1,000	7	45	65	86	100	120
2,000	11	80	120	160	200	240
4,000	15	150	230	310	390	460
6,000	18	230	350	470	590	710
8,000	21	300	450	600	750	900
10,000	24	370	550	730	910	1,100

For Example, if the average wind speed at the site is 12 mph, a small 100 watt generator will turn out only 11 kWh, but a 2,000 watt generator will produce 160 kWh and a 10,000 watt generator will product 730 kWh.



Troubled Times

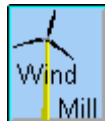

Tilt-up Tower

World Power Technologies of Duluth, MN has a new windmill with a 20 kW turbine. This would generate approximately 46,800 kWh per year, enough for several homes. There is currently a bill in the house of representatives that would give you a 30% tax credit for going with wind. We'll see where that goes. The real beauty of this thing is a 24 meter(80') tilt up tower. This means you could put it up and get it down for maintenance and other situations such as a major wind that could knock it over ... say in May, 2003.

Offered by [John](#).



Troubled Times



De-Mounting

Yesterday, when I had a day off in Denmark, I visited a Danish windmill maker. They have two windmills commercially available:

- a 5.5 kW model w/ 15m (50') open steel tower, 3-bladed turbine, down-wind
- a 11 kW model w/ 18m (60') open steel tower, fixed 2-bladed turbine (i.e. one wing), down-wind

They have currently no stand-alone models, and I am rather skeptical about the fixed wing and its inability to handle yaw. They are planning to develop a stand-alone 22 kW model, based on the 11 kW design, but with a flexible 2-bladed turbine, if they can get the funding for the development cost.

I had earlier been in contact with a Swedish windmill maker. They went silent after my last correspondence, when I started asking about being able to service the mill myself, manually de-mount and mount the tower top without the usage of external cranes etc. I plan on visiting them later this summer to get the dialogue going again. They manufacture a 20 kW model with an enclosed concrete tower, 30m (100'), flexible blade turbine, up-wind. They are planning a 30kW stand-alone windmill based upon the 20kW design.

The Swedish design seems to be the better one, but no way will it be possible to lower the tower and de-mount the tower top before the pole shift and mount it again after the pole shift. The Danish design seems less sophisticated, but the towers can be raised and lowered manually, and the tower top can be manually mounted (and hopefully de-mounted as well).

Offered by [Jan](#).

I had the opportunity to work in Denmark some 15 years ago on the Danwin Model 18 Wind Turbines there. There is a big stretch between a 5.5 kW and an 11 kW machine. What are your target requirements in watts? You can compute your needs by computing how many watts an appliance consumes when running in a peak condition.

Offered by [Jay](#).



Troubled Times

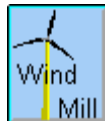

High Wind

A few years ago I was traveling from Arizona to Nevada and chanced upon hundreds of acres of commercial windmill electric generators. There were more than I would even try to count. I couldn't tell what material the poles they were made of, but expect concrete because of their size. They were huge, with blade diameters probably over 20 feet and the towers 10 times that. I noticed a group of maybe 20 in a rather isolated area that had obviously either been blown down or demolished. I happened to see a power company truck exiting a road that lead to the whole area and stopped him and asked what had happened to the downed towers. He said the weather service said a "micro burst" blew them down. Micro bursts have only been discovered in the last few years and many previously reported tornado damage areas were actually caused by micro bursts, associated with severe thunder storms, which contain short duration winds of as much as 200 miles per hour.

So, from that experience, any wind mill that can't be disassembled and stored in a safe place prior to the pole shift wouldn't have a chance.

Offered by [Ron](#).



Troubled Times



Promoted

U.S. Sets Goal For Wind Power

Associated Press, June 20, 1999

The United States would be able to produce 5 percent of the nation's energy from wind by the year 2020 under a new Energy Department plan, an agency official said Saturday. "We're going to try to double US wind energy capacity by 2005 and then double it again by 2010," said an Energy Department official, who spoke on condition of anonymity. "By 2020 it would be 5 percent." The level at 2010 would be 10,000 megawatts on-line, enough electricity to fulfill the annual needs of 3 million households, the official said.

Energy Secretary Bill Richardson will unveil the so-called Wind Powering America initiative Monday at the annual meeting of the American Wind Energy Association in Burlington, Vt. He also plans to announce \$1.2 million in grants for wind turbine-testing projects in 10 states, but the states' identities weren't released. "We think that wind technology has the most potential of any renewable energy technology right now," Richardson told *The New York Times* in a story for Sunday editions. Other leading renewable contenders are electricity from the sun or from sources like crop wastes. *The Times* reported that the federal government would try to reach 5 percent of its energy from wind by 2010, a decade ahead of the nation at large.

Energy officials said the department will invest money in research and development, encourage codes that are conducive to wind energy and encourage vocational schools to provide training in the necessary technology. The DOE official said the department will work to establish new sources of income for farmers, rural landowners and American Indians by involving them in wind power projects. The cost of wind power has decreased dramatically in the last two decades, according to DOE estimates. In 1980, capturing the wind as an energy source cost about 40 cents per kilowatt-hour, but now it costs about a nickel, the department official said.



Troubled Times



People Power

Excerpts from a December 7, 1997 *New York Times* article titled
Across Europe, a Tilt to Using the Wind's Power, by Marlise Simons

COPENHAGEN, Denmark -- On weekends, when Per Volund goes jogging around Copenhagen harbor, he is drawn to a pier with a row of sleek, modern windmills. As he watches the fiberglass blades spin in the breeze, he knows that they are sending electricity to the grid - and money into his pocket. Volund belongs to a cooperative that bought and installed four 160-foot towers on this prime spot by the sea. He is also part of a large Danish movement -- the Organization for Renewable Energy -- with a daring and ambitious goal. Its backers set out a decade ago to prove that even if big business or utilities had no interest in such experiments, private citizens could produce inexpensive energy that did not pollute.

"We call it power from the people," said Volund, a 33-year-old engineer.. "We do it because we believe in it." Like Volund, thousands of committed environmentalists, including students, professionals and farmers, have dug into their savings to buy turbines and licenses to operate them. They lobbied the government and the utilities until they finally agreed to buy wind energy. The result has been a quiet revolution. Today, close to 100,000 Danes own shares in the hundreds of small cooperatives that operate 4,700 windmills here. And they are making profits. Wind power generates 6 percent of Denmark's electricity, giving this country the highest per capita output of wind energy in the world.

While the American wind industry has stalled, wind power is booming across Europe, encouraged by improved technology, falling costs and government incentives like tax credits and guaranteed prices. Several governments have set targets to stimulate production. European policymakers point to the boom as a key example of how pollution can be cut without jeopardizing jobs or economic growth. With windmills springing up from the coasts of Sweden to the tip of southern Spain, Europe's wind industry already employs 20,000 people. One reason for the growth is that the European Union wants to diversify its energy sources while clamping down on polluters; almost no country could get the political support to expand nuclear plants. The other, more compelling, reason is that in many areas wind power is becoming economically viable.

Powerful new wind turbines can already generate electricity far less expensively than solar panels, biomass or other nontraditional sources, according to the International Energy Agency, a research organization based in Paris. Its studies show that wind energy is now becoming competitive with electricity from Europe's ubiquitous oil- and coal-fired power plants.. For wind, supply starts at the windmills, which do not require mines, oil fields, tankers, dumps, refineries and combustion. Moreover, windmills do not emit sulphur dioxide, which causes acid rain, and carbon dioxide, the most widespread greenhouse gas. "Wind energy is now one of the cheapest ways to cut back on greenhouse gases," said Ritt Bjerregaard, the European Union commissioner for the environment.

The future role of renewable energy is on the agenda for the international conference on global warming in Kyoto, Japan. Before the conference, the European Union announced a plan to double the share of renewable energy in its 15 member countries -- to 12 percent by 2010. Today's 6 percent share comes largely from hydroelectric power. But the new \$23 billion plan is a key part of the union's strategy to cut greenhouse gases. It will provide additional funds and incentives for wind, solar and other projects.

In wind power, Europe has already overtaken the United States, which led the drive to wind in the 1980s.

Europe's capacity of 4,100 megawatts now amounts to two and a half times that of the United States, with Germany alone surpassing the capacity of American wind farms. The way wind is produced underlines a curious contrast between Europe and the United States. American entrepreneurs, seeing wind as big business, built large wind farms with huge numbers of turbines. When oil prices fell and tax credits were cut because of policy changes, growth stalled. In Northern Europe, wind power is basically a cottage industry.

Denmark, Germany, Sweden and the Netherlands have each spawned grass-roots movements with small groups of often politically motivated investors installing one or a few machines at a time and scattering them across the countryside. In Spain, Britain and Greece, the clusters are larger because money has been provided by local governments and utilities. The latest trend in Europe is to start building wind farms offshore, where there is more wind and fewer complaints that they clutter up the landscape. "Many projects are small because this fits in with our history," said Marielle van Aggelen, a consultant at the Dutch Bureau for Wind Energy. Indeed, less than a century ago, before national grids expanded and electricity output became centralized, much of Europe was studded with the traditional windmills, often privately owned.

The Netherlands alone had some 11,000 windmills. Wind power pumped the lowlands dry, ran the sawmills and ground the wheat. Today, the Netherlands has 1,120 modern turbines. Some of them stand right by the old mills, which are preserved as cherished monuments. Arnoud de Schutter, a farmer at Wieringerwerf, a windy spot of the northern Netherlands, bought his first turbine seven years ago. It gave him the power to warm his home and cool his potato and beet silos. "I like it because it's clean energy and I did it myself," he said. After five years the machine had paid for itself and started to make a profit. He sells the surplus, costing him about 4 cents to produce, to the local utility for 7 cents per unit, a premium price, because the government adds in about 10 percent from environmental taxes it has collected from "dirty" conventional energy.

De Schutter, a neighboring farmer and two other partners have just put up another four turbines to operate as a business. They anticipate that the machines will produce net profits for 15 of the 20 years of their life span. "Some people think the towers are ugly," he said. "I think they look a lot better than electric pylons and high tension wires." Wind energy has complicated operations for the power companies, though. "The utilities complain because they have to deal with a lot of small producers like us," said John Springer, a former teacher who runs a Dutch wind cooperative near Vlissingen. Its 19 windmills are scattered around and owned by 1,250 stakeholders, who get 5 percent annual interest on their investment. "Volunteers keep an eye on the turbine closest to their house," he said. "They call if there's a problem."

For the moment, wind energy, like other renewable sources, still depends on subsidies like tax credits and guaranteed prices. But environmentalists point out that other energy industries have also long received government money for research. Besides, they say, the pollution from conventional electricity plants carries an economic and social cost that is not calculated in the price. There are other drawbacks. Wind is variable, and its energy cannot be easily stored, so it requires a backup system. "Wind cannot solve the energy problems," said Nils Anderson, marketing director of Vestas, the world's largest wind turbine maker. "But wind can participate, and these turbines are becoming an important supplement." Vestas exports turbines to India and China, where wind energy is on the rise.

At the Vestas plant on the Jutland peninsula in Denmark, Anderson showed the latest turbines, with a capacity of 1.5 megawatts, more than twice as powerful as those of a decade ago. "We're working on even bigger ones," he said. Design changes now allow turbines to start producing at very low wind speeds. Noise used to be a complaint. But the latest machines on Denmark's fields make a barely audible hum. Any doubts that Volund might have about the future were dispelled recently when his Lynetten wind cooperative placed an advertisement in a Copenhagen daily inviting investment in a new offshore wind-power venture. "There's such a big response, we're putting in more phone lines," he said proudly. "No one is romantic about this. First, it's a business. Second, there is a political consensus in the country to strive for clean energy. That's why it works."



Troubled Times

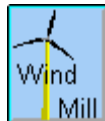

Communities

In August 1998, a windfarm capable of supplying electricity to **3500 homes** commenced operation near Crookwell in New South Wales, and another, double the size, is planned for nearby Blayney. Wind power looks set to become an important means of generating electricity worldwide.

[Nova](#)



Troubled Times



High Winds

There will be no TV or Radio weather reports after the pole shift. We will need to predict our own weather. I suspect hurricanes and tornadoes will occur frequently after the pole shift almost everywhere, with, over time, only some areas being susceptible to these patterns as is the pattern today. At some point we will need to do some predicting of the future weather patterns for the planet. As the speed of the wind begins to increase, how will we know until it is too late. We will be intent on growing and generating as much power as we can. I think it will be very easy for the wind to creep up to 120 mph and above before you know it.

Offered by [Mike](#).

Get a barometer.

Offered by [John](#).

A barometer will not tell you about wind speeds. It will tell you about the changes in atmospheric pressure. This can give you an idea of impending changes in wind and/or weather, but it won't tell you when the wind speeds will exceed X mph. If I remember my rudimentary meteorology, rising atmospheric pressure means incoming high pressure front which is usually associated with a warm front. Falling pressure means incoming low pressure front which would be a cold front. Either can bring rain and associated increases in wind.

Offered by [Roger](#).



Troubled Times

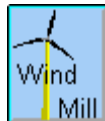

Brake/Lock

What can one do to save the windmill under these conditions? How do you stop it once it is going? At what speed of wind do you shut it down? Can one either by hand or with an electric motor and appropriate gears rotate the angle of the windmill so that it is perpendicular to the wind so that it comes to an almost stop. In stormy high wind conditions is it better to bring it to a total stop and tie down the blade? How does one do this? Are there any windmills designed to withstand higher winds? Ultimately, would the small or the large windmill fare better in high winds?

Offered by [Mike](#).

There is a windmill (now 50kW capacity I think) by Bergey that can be put up and taken down by three people for repairs etc.

Offered by [John](#).

Most decent wind generators will flare out at high speeds to prevent damage. The biggest problem won't be from the wind generator but from its tower blowing over. As far as braking and/or tying down, the instructions to do so will be with the wind generator. Each manufacturer may be different. 120mph is the highest speed most are rated, doesn't mean failure, just for the manufacturers, there was no reason to rate anything higher. Best thing to do would be to uninstall. Larger machines are more efficient, but will be harder to work with to install/uninstall. Sufficient diversion loads are generally built in to any decent wind generator.

Offered by [Steve](#).

Some of the windmill models are equipped with braking devices that limit the speed of rotation. These brakes are used to lock the blades in high winds. Of course, here in Kansas, we rarely see winds of more than 100 mph, but that will change. I do not know what the limits are of these braking devices, or how they work, I just observe the windmills in the area that are not turning, though there is wind. A simple device could be built to measure the speed of the wind. Use a fan blade and connect it to a bicycle speedometer (via a gear on the 'axle' of the fan blade that has the correct diameter for the speedometer). When the speed approaches 120 mph, just apply the brakes.

Offered by [Roger](#).



Troubled Times



Mount/Dismount

According to an e-mail from the 20kW windmill supplier, the windmill can be delivered with some sort of a "climbing crane" (whatever they mean by that) to be mounted on the steel frame tower and to be used instead of a car mounted mobile crane where lack of accessibility prevents the usage of the mobile crane. I plan to build an EMP-safe storage area not too far away from the windmills. Safe storage of the generator may however influence my choice of windmill size. I have not yet found out the tower top weight for the selected model. I did note however that the Jacobs 29-20, another 20kW windmill, has a tower top weight of 2300 pounds, and that smaller windmills like Jacobs Long (2.4-3.6kW) has a tower top weight of 550 pounds.

Offered by [Jan](#).

When a pole shift occurs, you will probably have at least a couple of hours before winds get pretty high. Gordon Michael Scallion has mentioned that a complete pole shift will occur in 3 separate shifts, so you may need to be well rehearsed on mounting and unmounting. It is certainly ambitious, but if you plan it ahead of time, you should be OK.

Offered by [Steve](#).

Maybe a better method for unmounting the tower might be to have the base on hinges (making it possible to simply lower the entire tower down to the ground and bolt it securely to ground.

Offered by [James](#).

Possible, but based on the size of the tower needed for the 20kW wind turbine, it would be pretty difficult to do. The smaller units would be a better possibility for that solution, though partial disassembly may be an easier choice based on the current design of existing systems.

Offered by [Steve](#).

There is a company that makes windmills that can be raised and lowered by 2 people - **World Power Technologies**. The Troubled Times pages point to this company already.

Offered by [John](#).



Troubled Times

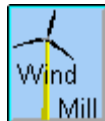

Ice

On wind generators, ice can be a problem. After an ice storm, either leave the generator idle until the ice melts or break the ice carefully with a stick. I heard that some people used ski wax on the props when winter neared. I'm not sure how successful that was. I think it would be safe to order or make extra props and wax them in the fall too.

Offered by [Darrell](#).



Troubled Times

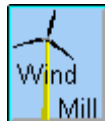

Cost

Wind Generators are any where from **\$500** for 300 watt unit, to around **\$2,500** for a 1,500 watt unit to around **\$4,200** for a 3Kw unit. Prices for larger wattage go up accordingly. Next comes charge controllers for the battery bank. **\$100** to **\$400** for 30Amp (standard) to say **\$400** for 120Amp. Trace Inverters are from around **\$2,200 - \$4,000** for 2.5Kw-5.5KVA and many in between for the good ones, i.e. high efficiency, "cleaner" sine wave voltage output. There are cheaper ones that computers may not run on, and radios might buzz some, but for the most part will work OK. I purchased a large dual 48 volt, 8Kw system that included the charge controller for about **\$6,800**. Again, this is a pretty large system.

I gathered my prices, in this research, from these sites among others: [Southwest Windpower](#) and [Real Goods](#).

Offered by [Steve](#).



Troubled Times



2 or 3 Blades

The windmill I'm looking at has a two-bladed turbine with a flap-construction instead of the more rigid three-bladed turbines. The vendor claims that this construction is self-adjusting, reliable, requires little maintenance, etc. Books and articles I have read so far about windmills recommend the three-bladed turbines as the best solution. Of all the commercial windmills I have seen, less than 1% have been two-bladed.

Offered by [Jan](#).

Three blades may have a little more stability, the trade-off is a little less power from the extra weight (inertia), but not real significant that you would really need to worry about it. As far as life expectancy, the 3 blade may be more stable, but as long as the 2 blade is balanced, you should be OK. Are the 2 and 3 blades interchangeable?

Offered by [Steve](#).

What about potential life span for a two-bladed construction vs. a three-bladed? The *Home Power* magazine said in an article about windmills in #65 that:

It should be noted that several of the manufacturers offer two blade and three blade versions of the same model. Because they're more efficient, two bladed systems put out more power at any given wind speed than the three blade versions. In my opinion, the added efficiency that a two blade version has over the three blade version is not worth the resultant shorter life span of the two blade model.

Offered by [Jan](#).

I remember an interview in *Mother Earth News* years ago with Marcellus Jacobs the founder of **Jacobs Windgenerator Co**. He resumed building generators after something like a 15 year shutdown, but I don't know where he went from there, he was 80+ years old at the time 70's or 80's. He invented the 3 blade propeller with adjustable pitch angle. He donated the patent to the government during WWII so they could use it on fighter planes because during high speed turns a single prop would tend to tear the engine loose from the mounts (the same thing can happen on the windgenerator and during much testing he settled on the 3 blade prop).

He also said "If you want power, nail a flat thin board to a broom stick", simple and cheap as well as effective, but not slick and efficient. Triangle shaped sails on broom sticks or heavy dowel rods would also work, you stretch them taut and the wind blows them into the shape necessary. Refer to the sail windmills seen in Greece along the coast. You could salvage an old pair of bluejeans for sail material or some similar fabric, you know. Any of these methods of prop or sail building would work well on our little model or a scaled up version, I think.

Offered by [Jay](#).



Troubled Times



20kW

The market for wind power seems to be split in a low-end (500W - 5kW) for point solutions and a commercial high-end (150kW and above). The middle segment that will be required for sustainable living after the pole shift does not seem to be very large yet. I have only found a few vendors with such windmills yet. Probably due to the price level, I don't think most people would want to invest for a mere 20kW unless they have a very good reason (like the pole shift), and they are too small for the commercial market. I have finally found a windmill in the right size, 20kW and available in my area.

Offered by [Jan](#).

Any manufacturer that you talk with will say theirs is the best. The 20kW and higher windmills will always be more efficient, but there are other considerations you may want to keep in mind. First off, you need some pretty significant equipment to mount (raise) and/or unmount such a heavy load. It's no small undertaking. If the cost doesn't scare you, the maintenance might. You may or may not be worried about the visibility of a larger tower needed for these larger beasts.

Using the 500w - 5kW ones, you can install multiple ones for redundancy and spare parts. They won't be as efficient and can cost more per watt, but on the practical side would allow you reduce your losses in case of failure with no backup. Regardless of size, another consideration would be to find ones with a permanent magnet motor, instead of the usual copper winding motor. In the event of a strong electromagnetic pulse, such as a strong solar flare or pole shift, anything with an inductive load would be the first to go. A permanent magnet motor would be least affected. I don't mean to scare you off the larger ones, you will have to weigh the strengths and weaknesses of either choice for yourself. I am only trying to give you some other ideas to consider when you make your decision.

Offered by [Steve](#).

I am fully aware of the backup requirement, so I plan to have two windmills and store spare parts for maintenance. I do however agree with you that the size may be a problem. I must be assured that it is in fact possible to de-mount the windmill manually before the pole shift, and mount it again afterwards. One major reason for wanting to use the 20kW windmills is in fact their height above the ground, so they will stand above the forest and catch the wind.

Offered by [Jan](#).



Troubled Times



Replacement Parts

A large EM pulse will probably cause a large enough current jolt to melt the wires and then insulation of the windings, thus shorting it out. Keeping spare thinly insulated wire on hand can be useful in rebuilding the motor by hand. What about using a small aircraft blade in a pinch? If worse comes to worse, you can fashion a blade out of wood. As far as spare parts, anything that moves will eventually wear out, so spare bearings would be important. Also complete technical plans would be helpful. A supplier may manufacture some of their parts, but most likely they will make use of as much off the shelf parts, as practical, to avoid unnecessary manufacturing. Try and get the location of any other machines close to you, not only to get feedback from current owners but also as a possible backup source to buy/barter for parts. What you learn from the experience can also be useful in helping others that decide to use wind power. If you go through with it all, like it or not, you will become an expert.

Offered by [Steve](#).



Troubled Times



Make or Buy

Of course, the best thing to do is to *buy* a ready-made wind generator. There are a number of manufacturers that there are links to on the Troubled Times site that make them. Unfortunately, they are *all* very expensive. You are going to need at least a 1 or 5 kilowatt unit to power some lights and pumps and stuff. 10 kW is what I am shooting for. But most **10kW generators** are pretty big and cost 20 grand and up. Lots of cash I don't want to spend.

The main reason why I have considered this more than a homemade one is for one main reason. The good manufactured windmills allow you to adjust the *pitch* of the blades. Some do this automatically. You gotta be able to do this or else when a storm comes the damn thing will tear itself apart. If the **blades** can be turned on their **axis**, you can adjust how much wind catches the blade. You can even turn the blades so that the wind passes right by without moving it. You see, unless you have an electronic regulator, the *speed* of the generator will affect the electricity coming out of it. Commercial units have this built in too. Of course, you could take the thing down every time the winds get too fast, but there's gotta be a better way than that.

Being a student who is near broke to begin with, I intend to try a homemade job anyway. I plan to try and get my hands on an old **airplane propeller** that has the ability to adjust the blade pitch. I don't know if a airplane prop will work, but at least I can get the idea as to how to mechanically turn those blades. Then maybe I'll make some lighter blades out of sheet metal or something.

Offered by [Rob](#).

Check out **helicopter blades** as a possibility. Another possibly is to buy only the blades from one of the cheaper windmill vendors.

Offered by [Mike](#).



Troubled Times



Used Windmills

Before anyone runs out to purchase any used wind turbine parts from a junk yard there are a few facts that one should know. The [ESI 54S's](#) are very reliable machines. They are being removed from their present locations to make room for newer and larger machines. These large machines are virtually useless for a stand alone application. They require connection to the three phase grid for their overspeed protection. The grid provides a rather tremendous load upon these machines matching the turbines rated power output exactly due to the physics involved. In essence one would be required to match the output capabilities of the turbine *constantly* for safe operation. I can't think of anyone I know who requires a constant 85,000 watts for domestic use. These machines also require the grid to excite the stator windings before power generation can take place.

Imagine a turbine with a 54 ft. rotor diameter flying apart from an overspeed condition. It is not a pretty nor safe event. Anything coming from a junk yard is just that, *junk*, especially when you don't know what your doing or what to look for. When these machines are torn down they go through very brutal treatment. The most important sub-assemblies "the Hub and Blades" are usually the first to go, the hub for smelting as it is made from cast steel, and the blades for recycled plastics. The demand for these materials is astounding due to the energy savings involved in reprocessing. Smaller turbines such as the **Carter 25** might be used for stand alone applications with some modifications. For anyone interested in used wind turbine blades for modification consider [Customizing Tips](#) and [Reconditioned](#) wind turbines. I would hate to see anyone go to the expense of purchasing one of these used turbines and then have to sell it back for scrap at about \$0.21 on the dollar.

Even if one is offered a very attractive price, there are a lot of logistics involved in the consideration of their usage. It is conceivable that six machines could be used to power a small village or enclave, but you would require *very favorable* wind conditions and placement for proper operations. If each machine would come with one complete set of replacement blades it would be a dream come true. You might contact the sales department and ask if they include the maintenance and overhaul record of each machine (serial no. contactor hours for each sub assy. etc.). If these records are unavailable, then count on the fact that something is rotten. Most states would require that the owner of such machines have a minimum of \$1,000,000.00 in liability insurance per machine and no wind turbine with a rotor diameter larger than 30 ft. be installed closer than 500 ft. to a dwelling. There are just so many logistics involved; check out the laws in your area before considering such an endeavor.

Offered by [Jay](#).



Troubled Times



Make Shift

Setting out to build a make shift windmill needs to be broken into several needed actions:

1. What would be the best make shift wind mill or for that mater what is the best water driven generator constructed after the pole shift from commonly available parts?
2. What is the best before pole shift construction of purchased or available items.
3. What is the best (most cost effective versus quality) available off the shelf purchasable windmill and the best water powered generator as a fully assembled unit of parts.

Stay away from speculation. Rather than invent it all over again now is the time to scrounge find existing technology. Search the manufactures for what will work cost effectively. Search for those who have done point 1 and 2 above. See and report on how they made it work. We need to start where others have left off. Lets do our home work first.

Offered by [Mike](#).



Troubled Times



Existing Technology

Find out what has been done by others. Stand on existing technology. Do a good search of what is available in the way of cost effective parts and or assemblies for both windmill and water power (Pelton and paddle wheels). As an example: we might buy the propeller from one place and the generators from another and the tower from a third. It's one thing to simply give a shopping list of all possibilities as we are doing now, it's quite another to with an engineering-electro-mechanical practical eye toss out the garbage and narrow it down to several best recommendations. If we don't do this last stage then every one will need to do it before buying. In other words we need to do a consumers report and decide what is best. So far we have been just collecting data. Soon we will need to act and build or buy.

I once worked in a research Lab as a research-scientist we used to all the time reinvent what was already invented just because we were too lazy to research what had been done, and it was also more fun that way. This is typical in all research and development efforts. What I am saying in my ranting and raving is we don't have time for it. Do your home work and the answers will be found for all of us. There is a lot of smart people who have gone before you and me. Find them and report on what they used and did.

Offered by [Mike](#).



Troubled Times



Car Parts

Turn a car on it's side on top of a hill. Bolt two wooden planks to the tire rim that is now sticking up in the air. Take several garbage cans and round the bottom with a hammer, cut the can in half, and mount each half on the plank. The result will look like a crude wind speed indicator, the type that has a half sphere at the end of two cross pieces (looking at it from the top view). Use as many garbage cans as you can find and point them all in the same direction. The upper half of the can will work with the lid attached. The result a vertical wind mill.

Now leave the engine in tact and you can compress air for powering air motors. Not very efficient but possible. The air conditioner compressor will also make a good air compressor. Or, disconnect all connecting rods, timing gears, etc. from the crank shaft to minimize friction. Use the transmission (assuming it is standard and not automatic) to control the proper generator speed. Add more car generators use the air conditioner belts to drive them. Generators can be wired in series to bring the voltage up to 120 V DC. Depending on speed could take 9-10 or more alternators. More than one generator will need to be driven by each belt. Use wood to mount them. 120 volts DC will power some light bulbs (incandescent) and some appliances (hot plates) and some power tools.

I say all this - but I am reluctant to publish it as a solution until it is tried out. Maybe trash cans won't work. Possibly not enough turning power. Might have to cut the trash can in half top to bottom or make funnel shapes out of some old metal building or old signs instead. It might be the Dutch wind mill shape made of wood using a series of car rear end parts and a transmission would be better. There are lots of possible variations on the above. Until someone gets out there and tries it, we won't know what works and what doesn't. The point is, this has probably already been done somewhere on this planet. We just need to find the write-up on it. If one wants to test home-made windmills, then it would be worked by those who have mechanical ability and availability of these types of parts.

Offered by [Mike](#).

It seems to me the best use of windpower would be to mount the windmill directly to the generator. Electrical generators run at efficiencies approaching 90%. Cars have an efficiency approaching 15%.

Drew

Most definitely a makeshift windmill, made up from what you have available after the pole shift, will not be efficient. If one has the chance to prepare before hand and wishes to make a windmill, the best thing to use would be a slow speed generator that has permanent magnets. A second would be a converted slow speed DC motor that has permanent magnet fields. Even at this a gear train, belt or chain drive will be needed between the windmill blades and the generator to get the optimum speed for efficiency. Then one needs a way to regulate power when the wind blows at different speeds. All things considered it is probably better to buy a commercial product if one can afford it.

Offered by [Mike](#).



Troubled Times



Paddle Wheel

I am looking at the possibility of constructing a horizontal paddle wheel type windmill on a windy hill out of an old car and a high cut off tree stump.

- The car would be blocked up in the air (at paddle height) a given distance (width of the paddle wheel) from the tree stump.
- A paddle wheel axle would be made out of a tree trunk or a 4x4 (bigger if available). The Paddles could be plywood or sheet metal bolted to the axle.
- The axle of the paddle wheel would be attached to the rear axle of the car and extend parallel to the ground over to the tree trunk.
- The front wheel axle and wheel hub assembly taken off the car could be mounted on the tree stump such as to carry the weight and wind forces of the paddle wheel.
- A fence of wood, dirt or rocks built up on either side of the paddle wheel would deflect the air to the top blades of the paddle wheel.
- The engine of the car would be removed.
- The transmission could be left in to help get the correct gear ratio.
- Transmission shaft with pulley and belt to generator(s). On the opposite side of the rear wheel, brake locked or rim tied so as to not turn.

If one had enough old cars, one could make a series of windmills, the paddle wheel going from rear axle of car-1 to front axle of car-2. Car-2's rear axle would be connected to car-3's front axle and so on with the last car using a tree stump or something stable to attach the bearing point. Top view with car missing left wheel and axle assembly:

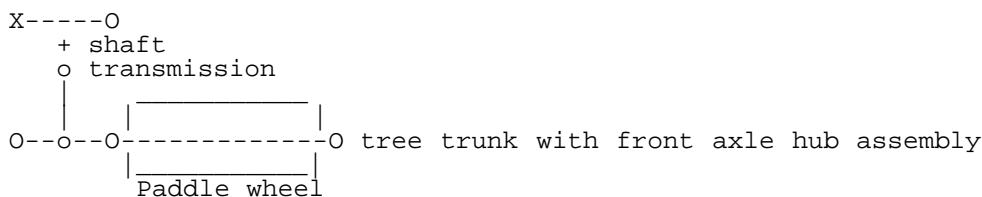

Items left to be determined how best to be done: Attaching the wood axle to the car wheel or hubs. Attaching the front axle hub assembly to the tree stump. Optimum height and width of the paddle blades for the paddle wheel. If this gets too high, then, centrifugal force could tear it apart. If it is not high enough, then the wind will not turn it with enough force to reach optimum speed, thus loss of power would occur. Whether 4 blades on the paddle wheel are enough or are more needed.

Offered by [Mike](#).

It will take a lot of wind power to turn the shafts and transmission, etc. before this motion reaches the generator. The Nebraska type would be cheap and easy to build from scrap lumber with a little imagination. The paddles could be as simple as 2 x 2 board frames covered with cloth like canvas. This would cut costs.

Offered by [Darrell](#).



Troubled Times



Generator

I saw a water pump driving a generator about 15 years ago. I only drove past it a few times and noticed it. It seems like a generator was used as opposed to an alternator, and it would probably work better with a generator as they charge at a slower rpm. He was using a radiator fan blade for power. Note, this may have been a truck fan blade and water pump. The fan was the symmetrical type, 6 blades I think. You can rewind generators and alternators for a slower speed. The *LeJay Manual* covers all of this. Take the windings out and rewind with twice the number of turns (smaller diameter wire) . You will cut the amperage out in half too. You can replace the field coil with a permanent magnet too. If you want to do this but don't have the skill you could find a motor repairman that could do that.

You know, a lot of fan blades look like they would be off balance if used for power. He merely carved out a wind propeller from a 2 by 4 board. The problem he had was the blade was a little off balance and made a whop whop sound much like a helicopter. He had it mounted on the roof of the house on a wood tower. He had to shut it off manually by turning it out of the wind and tying the prop with a rope. It worked really well for a while. Then the wind got really hard one day when it was running and the off balance problem greatly increased, snapping the cam shaft off. That was the end of that. I forgot to say above that he bolted the prop to the cam gear to provide the geared up power to the generator. I also saw many homemade windmills around those days, as everyone around there was in the same boat with power.

Offered by [Darrell](#).

I have been collecting from ham swap meets, spools of copper wire and those strong new type permanent magnets for just such an experiment. I think that most people will simply use the more practical approach, adjusting pulley sizes to optimize speed and power. So ideas on how to do this are appreciated.

Offered by [Mike](#).



Troubled Times



Water Pump

Once I saw a wind generator with a 60's or 70's car water pump and fan blade belted to a generator mounted on a board on the roof of a garage. It probably worked until the bearings went. I might try that, but I would put a rubber hose from inlet to outlet and fill it nearly full with gear oil - sae30 or maybe 90. Use the hub of the fan blade. Cut off the fan blades and bolt a broom stick or long 40 inch dowel rods of broomstick diameter and bolt a square piece of tin or masonite maybe 1 foot square to the outside end at a slight angle to catch the wind. Mount it on a 2x4 board or 2x6 would be better about 8 10 ft. long with a 2 ft. by 4 ft. piece of tin or masonite for a tail. Then mount it on a bearing so it can turn into the wind. You could use a car wheel axle there.

Offered by [Darrell](#).

I like the idea of using a car water-pump-generator. I don't think it is necessary to close the water pump up with added oil being pumped all the time. The ball bearings in a water pump do not run in the water, but runs on the outside of the water seal with a drain hole to the outside air. The typical water pump ball bearings are individually packed in grease with dust seals of their own. What makes a water pump go out on a car is when the water leaks past the water seal and gets into the ball bearings washing away the grease. If one just ran this pump dry the water seal would soon wear out, but this wouldn't heat anything because water would not be put into the pump. The bearings being self lubricated and sealed should last as long as they last depending on the balance and speed of the constructed windmill. I think adding ever widening flat boards bolted to the existing metal of each fan blade might be an alternative, that would also work. The biggest concern I would have would be the pulley size ratio not being great enough in order to run the generator fast enough. This water pump driving a generator with a belt idea, is simple, light and easy to construct. I like it.

Offered by [Mike](#).

I didn't know that about the water pump bearings. I think I looked at an older Ford water pump about 15 years ago with that in mind and it was open in the back so the impeller was exposed. I think it had a brass bushing bearing and it was shot. I was always told that if you put water pump lube in the radiator the water pump will last longer. I think we are thinking of different vintage cars. But what you said sounds fine about the ball bearings. Now I may build one.

Offered by [Darrell](#).

Water pump lube put in the radiator helps just keeps the water pump seal from wearing out. It never makes it to any bearings whether old or new cars. If this seal wears out then the ball bearing on the other side of the seal wears out. For those who plan to build this type of windmill, I recommend checking the small drain hole near the front of the pump (near the shaft but below it about 1"). If this has evidence of water deposits dried out, and if you have a choice, don't use the pump. It probably was about to go bad due to water leaking into and through the ball bearings to make it to this drain point. If it's the only one you have, then check the wobble or wear of the bearings from time to time and use it anyway.

Offered by [Mike](#).



Troubled Times



Tire Rim

A pulley could be made out of a car's tire rim without the tire. The multi-rigged wide V-Belt (typical of today's alternators) rides in the low part making a very large pulley. Another possibility, a pulley could be made out of 3 round pieces of 1/2" to 1"+ plywood sandwiched together. This would depend on belt width. The center circular piece would be about 1" smaller in diameter. The inner edges of the two outer plates would be rounded or beveled on the inside so as to not excessively wear out the belt. In this case the pulley could be built as large or small as needed. Rope or string could be wound around the alternator's pulley to make it even or higher than the diameter of the sides of the typical alternator pulley. This could be finished off by soaking it with epoxy and letting it harden. The built-up area would keep the pulley edges from cutting into the car tire, making the tire last longer. The 2"x4" could be a 4"x4", 2"x6" or 2"x12" as needed.

A typical 14" car tire has a diameter of about 23" to 26" depending on type. Assume 2000 RPM is a good working speed to get useful wattage out of a car alternator. Assume 300 RPM is the maximum speed for the tire-propeller. The alternators that I have measured range from 2.2" to 2.8" in diameter. Note that:

$$\text{PM(gen.) times diameter(gen.)} = \text{RPM(Tire) times diameter(tire)}$$

If this is solved for propeller or tire speed we get the range of

$$\text{RPM(tire)} = (2.8" * 2000\text{RPM}) / 23" = 243 \text{ RPM or } (2.2" * 2000\text{RPM}) / 26" = 169 \text{ RPM}$$

This indicates that the optimum generator speed is within the range of possibility for this design. Thus it should be possible to efficiently use a car generator for such purposes. The larger the tire and the smaller the pulley, the lower the speed of the propeller for sufficient current to be generated. The optimum propeller design and size could be arrived at by trial and error.

Offered by [Mike](#).



Troubled Times



Axle Paddles

You can take a nail, string, and pencil, draw circle on a heavy piece of plywood, and bolt that to your axle 4x4 and the car axles. The hardest part would be the bolt circle pattern where the wheel mounts to the hub. I would make the circle of plywood the same diameter so as to fit inside the wheel rim and then mark the hole pattern. Do it with cardboard from a large scrap box first and then you can look at how it fits before you waste a piece of plywood or whatever. An old carpenter's trick I learned once. You might use 2 car front axles like that and mount a v-belt pulley (large as you can find) at the one end. 8 inches or more diameter. The 4 ft. by 8 ft. paddles may not develop enough torque to turn that car axle, drive shaft and transmission. You may need paddles on the order of 8 x 16 ft. to turn all of that.

You can carve a propeller from a 2x4 like my Dad did. If you have a rotating sander it would help. Remember the longer the prop the more horse power. It's really a rotating lever. 6 or 7 ft would be OK for what we are discussing. Keep the angle slight to start in slower wind. The leading edge will be rounded to the backside and tapered to the following edge like an airplane wing, which in effect each half resembles somewhat. It won't look like the airplane propeller. The Nebraska type doesn't work only in one direction, it works in about 6 angles like an x with a line through the center but half of the rotation would be in reverse which doesn't matter if you're grinding grain or pumping water, but most of our wind is prevailing westerly. If the axle runs north-south it won't work in north or south winds. We hardly see any here. But you can make it work in all directions and leave out the fence. You build it from canvas and run the sails at an angle instead of straight across and it will look like a large screw shape. There are many variations of this design.

Offered by [Darrell](#).

If I am understanding you correctly, your mock up would work fine on the rear axle to paddle wheel axle interface, but may not have taken into account the front car axle on the hub assembly sticking out further than the bolts that hold the rim on. One would need to cut a hole in the end of the 4x4 or use very, very thick plywood. A possible way to attach the paddle axle to the front car wheel hub assemblies. Turn the tire rim around and bolt it back on the hub using the same lug nuts. In most cases, this will cause the outer part of the rim to extend beyond the tip or end of the car axle. Once this is done, plywood or a 2"x8" can be cut to fit the size of the rim. This 2"x8" or plywood piece would then be bolted to the end of the paddle wheel axle. With long bolts and possibly spacers this wood piece can be bolted to the tire rim. Either drill holes or use the gaps and slots already present in the rims to assist ease of construction. Under these conditions - what do you consider the maximum blade width and height for a paddle wheel so constructed? Would you use 4 or more paddles?

What's the best wood to use? What's the technique to balance windmill blades and paddle wheels? What I can think of now is - mount the blade or paddle wheel on its bearings free to rotate. The heavy side will rotate to the bottom or closest to earth. Shave off some of this bottom side until the paddle wheel or propeller can be turned to any position and it just hangs there without rotation. Now get it rotating as fast as you can. With a pencil or chalk hold it to barely touch the shaft on the high side as it wobbles. Be careful not to get in the way of the turning propeller or paddle wheel. Now stop the blade and take off more material on the side where the mark is. Repeat until balanced with minimal shaft wobble. In some cases weight may need to be added to the light side. This will be the case if no material can be taken off the heavy side. For example, paddle wheel type with canvas over 2"x2".

Offered by [Mike](#).



Troubled Times



Electrical Systems

A simple DC generator can be made out of a car alternator. These little jobs generate AC, but there is an internal rectifier and regulator that makes it into a constant (sort of) 12-14V DC. And just as your car engine changes speed from maybe **500 to 5000 RPM** while driving, it will work over a long range of wind speed. The only problem is that a normal alternator (like my AC Delco) will only put out 80-100 Amps. Some simple **ohms law** says that

$$\text{Power} = \text{Voltage} \times \text{Current}$$

so best case

$$\text{Power} = 100 \times 14 = 1,400 \text{ Watts}$$

So even a car generator can give you 1 or 2 Kw. Good idea for a backup at the least! Only thing is you only have DC, 12V, and most appliances need 120V AC. They sell power inverters that let you do this conversion, but the higher the wattage the more expensive. I think a 1 Kw unit is pretty bulky and a few hundred bucks, but hey, you can run almost anything then.

Offered by [Rob](#).

Use a quantity of **12 car alternators** wired in series and all driven from the same adjustable pitch propeller. Build this by use of belts, bicycle chain, or gears to drive all alternators at the same speed off of the same slow speed propeller. The **120 Volt DC** output can be used directly to produce resistance and diode type lighting to grow our food and for task lighting. Many other appliances can also run on this DC 120 volts. 12 x 12v batteries are wired in parallel and are being charged all the time to help stabilize the voltage as demand changes. A high voltage DC inverter is used for the small amount of AC that is needed.

Adjust the propeller pitch to regulate voltage as you have suggested. It may be possible to design it to not need the 12 volt car regulators. I have found the most common alternator to be **55 Amp**. Thus the result would have a maximum of about 6,600 watts to **12,000 watts**. This depending on whether a cheap or more expensive alternator is used. Rebuilt alternators are relatively inexpensive. The use of 120 Volt instead of 12 Volts allows for smaller wire to be used.

Offered by [Mike](#).



Troubled Times



VITA

VITA, a government agency, put out a booklet on making a wind generator with car parts. They used the rear axle with one brake bolted locked and a large v-belt on the shaft where it came out of the differential. They made a fan wheel that was like 10 ft. diameter on the other brake drum and a large tail vane on the locked end to steer it into the wind.

Offered by [Darrell](#).



Troubled Times



Model T Ford

I was born 1946 in east S. Dakota and the farm area there was quite late getting hooked up to the power lines. About 1960 my dad's farm was the last and furthestmost customer north of the power co-op. We survived using kerosene lamps for light and a windmill water pump to water livestock. We had a 6 volt tube type Radio and charged the battery for a while with a homemade wind charger that my dad made with a top of a **Model T** engine block. The **Model T** (Ford) engine was junk because of a broken crank shaft. It had a cam shaft with a large gear at the front of the engine driving the 6 volt generator from the engine. Dad just bolted a prop to the large gear with 2 bolts. No pistons or oil pan or other moving parts. He climbed up there and oiled the moving parts regularly with an oil can.

Today's engines are a lot different. You might be able to do something similar with a lawn mower engine or something. I understand a lot of them have been junked. Some of them, 8-10 horse, use a generator/starter combo to start the engine and charge the battery after it is running. You might use that, but those only put out 10 amps (maybe). If you make a prop, balance it somehow. I think a lawn mower blade balancer may work, or an old type tire balancer, the one that is cone shaped.

Offered by [Darrell](#).



Troubled Times



Tire Prop

I was wondering if you could give a rough order (or at least point out how one would approach it) recommendation on the approximate size of props to use if one were building the larger version using a car tire and an alternator. You could make whatever assumptions you wish. I am currently thinking along the lines of what will most commonly be found after the pole shift. For example say 100 amp alternator maximally capable of 1200 watts but under the circumstances say it will put out about 500 watts. 13 to 14 inch rim-tires. Average wind equal to average winds found today. Could use 3 or 4 propellers not sure the width of the most common molding. Not sure how to arrive at best angle to use based on wind speed. Some guide lines and considerations could be helpful.

Picture a tire mounted on a bearing on the end of a 2x4 using a angle iron to mount the tire bearing shaft to the board. A pipe flange with a stand pipe for the swivel mounts on the bottom of the 2x4 so that it can turn in the wind. You use 2 pipes. There are 2 where the outside diameter is the size to fit into the inside of the other. the larger one is fixed to the tower, house or whatever, the smaller one rotates inside the other mounted pipe and the wire from the generator can be passed through the center of the smaller pipe. On top of the 2x4 a block of wood with door hinge mounted on top and between a flat board mounted to the bottom of an alternator. The shaft of the alternator with a knurled knob replaces the pulley and rests on top of the tire with the hinge and board attached to the alternator holding it in place. A tension spring between the alternator and the 2x4 holds tension between the alternator shaft and the tire. A cowling cover is constructed over the alternator for weather.

Offered by [Mike](#).

I would try to move away from the tire idea in this application for several reasons. It will require a larger than normal rotor area for self starting, complicating formulas used as we need to keep it as simple as possible. Used tires are usually hard and slick, making them difficult to mate properly to an auto alternator. An auto alternator needs to be extremely tight to operate properly under the heavy loads required for wind generation. With an auto alternator you would need to fabricate a collar, and then what would happen if the tire lost it's inflation? You would loose your generator mating, and eventually the tire would start to spin on it's rim. The gear ratio is important here, we need to be able to create a system that will have ease of starting at a very low wind speed. We usually try for a starting speed of 10 m.p.h..

Imagine yourself having to climb up or lower a 30 - 60 ft. tower just to air up a tire, are you going to use an air hose (you just lost your power) or are you going to use a bicycle pump on a car tire? I think I will avoid that possibility at almost any cost. Every time you have to do either you are creating a dangerous situation for yourself.

Offered by [Jay](#).

After the pole shift, I think the tires we would find would have plenty of tread on them. Most likely being take them off the cars no longer running due to no gas in the area. I think the main problem is if these weren't taken off before the pole shift, they may get punctured during the high winds of the pole shift. A collar could be done with epoxy soaked into rope or string wound around the pulley to bring it up to just above the edge of the alternator pulley sides. If the tire lost it's inflation you would need to pump it back up or change it out. I think a heavy spring could be used to keep the generator in contact with the tire independent of inflation. I think even if almost flat in most cases the tire will be stiff enough to drive an Alternator. In high wind and high power usage situations I can see some potential slippage at the point of tire contact with the alternator modified pulley. I think spring tension to be the key.

To pump up the tire, I think a small pressure tank pumped up with a bicycle pump on the ground, strapped to ones back to climb the tower, would do it. I saw one at wall mark that would work (a couple of months ago) that was on sale for \$20. I agree that a properly rain shielded chain drive would be better in the long run, if one can find the parts after the pole shift. If one left the chain unprotected in the rain, then I doubt it would last long. The near constant rain would wash off the grease and soon rust and/or collect grit mixed with the grease that will be in the rain-ash mix. I expect in this case it would soon ware out and the rubber tire approach to be a viable alternative. Climbing the tower to put grease on the chain has the same inconvenience as pumping up the tire occasionally.

Re the size of the tire blocking the wind. I think the formula would be accurate enough especially if one used a metal cone (made out of sheet metal) shape to deflect the wind to the edges of the tire. A large sprocket would also block the wind to some degree.

```
wind ----> <|  
< = cone  
| = tire
```

Offered by [Mike](#).



Troubled Times



Axle Prop

I just recently helped a gentleman put together a system with similar requirements. He had several novel ideas and used only hand tools except for an electric saw and drill. He took the rear axle from a front wheel drive 1982 Chevy Citation and cut it in half with a hack saw. He said it was easy and only took a few minutes. He kept the emergency brake cables intact for later use. He then mounted one half of the axle to a 20 ft. X 2 inch length of thin wall tubing (from a recycle center at about \$6.00), using three U bolts made from all-thread as his yaw bearing. Next he made a rotating table out of scrap 5/8 inch particle board flooring material salvaged with permission from a job site. He cut his table to a rectangle 1 ft. wide and 3 ft. long, reinforcing the underside at both ends and both sides with 1 1/2 X 1 1/2 X 1/8 inch scrap angle iron salvaged from an old bed frame, also cut with a hack saw and drilled for bolting to the table. Next he mounted the table to his yaw hub, centered at one ft. from one end for use as a downwind machine. He used two 2 1/2 ft. 2 x 6's then glued and screwed them together with wood screws. He centered these on his rotating table, stood them width wise up so he would have enough room to keep the other hub over the table with only 1 inch of the hub and the bolts protruding over the edge. Again he mounted the other half axle with hub to the table using some more of his drilled angle iron and all-thread clamps, 3 inches from each end and again in the center.

When he got this far he decided to call on me, as he drives by our place most every day and sees our machines flopping around in the wind.. We introduced ourselves and exchanged some pleasantries he then asked me " is there something I need to know before I make my blades". We had a long discussion of the pros and cons of several different approaches, He had read the "LeJay Manual" so he had some sense of wind. He decided on a two blade rotor for simplicity and reliability. His alternator was from a Volkswagon Jeta. This generator has a rating of 14 volts / 40-100 amps beginning at 2,000 r.p.m..

The bolts in the hub were removed and replaced with longer ones to accommodate the gear up drive and rotor blade assy. Then sprockets were removed from two 27 inch ten speed rear bicycle wheels, of course they were a match. He used two large sprockets aligned and of the same size on the hub, drilled them appropriately and separated with two washers of proper bolt size. Again with two sprockets of the proper size for a 9:1 ratio or near to it, he drilled and mated to the alternator these sprockets with three small bolts to the original pulley in a similar manner. What he did was use a jackshaft. On the brake hub he used two sprockets of 30 teeth attached by chain to a jackshaft With two of ten teeth. Again on the other end of the jackshaft two sprockets of 36 teeth. Now Finally on the alternator two sprockets of 12 teeth. This is not an unusual configuration for a homemade wind generator. In each stage there is a ratio of 3:1, $3 \times 3 = 9:1$. A gear ratio 9:1 allows the machine grater ease of starting in low wind regimes.

Never use gear boxes on small generators, they cost too *&%\$#@ much! The reason that the sprockets were separated with washers, was to make room for two chains (redundant reliability). He used the original mounting bracket attached and aligned to the underside of the table to attach and adjust his alternator. This approach works very well as less force against the bearings are required than if belts are used. Whenever you use chains on any machinery, *watch out!* Fingers can now be sewn back on but it hurts a little.

Offered by [Jay](#).

A gear system would last longer. The only thing is a gear system needs to be kept running in oil. This may be a problem after the pole shift. Oil seals leak especially if axles are turn with one side down. Availability of Oil will be scarce. Also, I believe the gear ratios of a rear end axle (if this is what you would use) to be not as high as can be obtained from a car tire perimeter driving an alternators modified pulley. One could use the alternator belt under tension around a wheel rim as a big drive pulley. This would work as long as the belt is long enough to go around both

pulleys.

Offered by [Mike](#).



Troubled Times



Axle Math

Here is where the math comes in, it's pretty straight forward stuff. All formulas that we will use here are in meters, we can convert them into inches when we are finished. The formula to compute the diameter of any home made wind generator comes from Hugh Piggott a world leader and author involved with home made wind power. This approach is actually a little backwards as we are starting with only one variable the generator.

Here it is,

$$\text{Diameter in meters} = (P/C_p * (24.5 * \text{TSR} * G / \text{RPM})^3)^{0.2}$$

Where

- P = Output in Watts
- C_p = Power coefficient <C<sub>p
- TSR = Tip speed ratio <TSR>: Use 7 here
- G = Gearing up ratio <G>: Use 6 here
- RPM = generator rated r.p.m. <RPM>: Use 2000 here</sub>

The other integers in the formula are " Constants " that are not changed for horizontal generators. All of the variables that I have used are conservative ,as they should be for a home made wind generator. Because the material for fabricating efficient blades will be difficult to find I have used a tip speed ratio of 7 for a three bladed hub that will still be fairly efficient if using rather crude blades. Power in watts = 14 volts X 40 amps (low end production to assure power production at low level wind conditions) = 560 watts. So our formula now reads.

$$\begin{aligned} \text{diameter} &= (460/0.2 * (24.5 * 6 * 9 / 2000)^3)^{0.2} \\ &= 3.66 \text{ meters} \times 39.37 \\ &= 144.09 \text{ inches for the rotor diameter.} \end{aligned}$$

Now we have a rotor diameter, in a day or two we will size our blades area for optimum performance under certain wind conditions. The wind generator I have described above has now been in operation for a little over three months requiring no repairs and no maintenance. Just a note: for those of you having trouble with integers, and don't have a scientific calculator, download Sicyon V1.5 and use the arithmetic function. I don't remember the web site but it should be easy to find.

Offered by [Jay](#).



Troubled Times



Results

These are his results (he keeps great daily records) he doesn't have an anemometer so the wind readings are from a local community air-strip 4 miles away, lets say + or - 5% reliability. He is using an analog amp meter. I tested it, it's fine.

The results are as follows:

MPH	Amps	Volts	Watts	
10-12	38	13.8	524	Excellent!
14-20	56	14.0	784	Excellent!
16-25	73	14.0	1022	Excellent!
28-34	89	14.0	1246	Excellent!

These are rather wonderful results coming from an auto alternator. All of these readings were taken under rather rigorous conditions. He used a new 1000 watt 220 volt water heater element for two minutes, not to overload or overheat his alternator. His blades have taper but no twist. His alternator is over 8 years old, but is made by **BOSCH**. Rebuilt units without core run in at about \$120.00, a little expensive, but if you can get your hands on a used one in good working order you have a little powerhouse on your hands. He uses this little daemon to charge two banks of 8 X 12 volt batteries, connected in series-parallel for a total of 240 volts. I can show you how this is done. It is a common configuration for many Photo Voltaic systems.

Offered by [Jay](#).



Troubled Times



Horizontal

Try looking into Savonius turbine designs and perhaps picture that on a horizontal axis. The light bulb wasn't invented until thousands of failed ideas and designs went by. I am going to try to build horizontally mounted savonius type turbines using sections of abs pipe cut in half as the "blades" or buckets however you want to look at it (look up savonius windmills and you'll get it). My thought is to make a series of several 4 ft (ish - I'm going to tweak till I get it right) long ~1ft diameter turbines driving a separate small car alternator each. I will then wire them up in parallel. That's the concept at least - I'm just now prototyping a small version. The advantages I see are cost, easy maintenance (nearly ground level), cheap (could possibly crank them out at less than \$100 a pop), low profile, less noisy (I'm hoping) etc. As far as efficiency goes - they will certainly be way less efficient - however there will be many of them and the overall wind being harnessed will be much more than what I could handle by making a standard rotary 3 or more bladed windmill. Not to mention my neighbors wouldn't like it much.

Offered by [Ken](#).

I am familiar with "savonius windmills" and think that is a good choice. I do think rather than mount it horizontal that vertical mount would be better. This would allow the wind to blow from any direction and make it work. If the generator is at the top then a large plastic or metal container could be put over it to protect it from the weather. If the generator is at the bottom then rain water can get into the main shaft ball bearings. In high winds the centrifugal force of rotation will tend to tear it apart unless a method of decreasing the surface area of wind exposure is provided. One way to protect against high winds would be to hinge the unit from the generator or highest end. As the wind blows harder the bottom part exposed to wind would cause the whole unit to hinge away from the wind, causing less cross sectional wind area to hit the savonius blades.

The next thing to look at is slow speed. Permanent magnet DC motors are more efficient at generating electricity than car alternators. Car alternators produce maximum power about 2000 RPM and at 500 RPM (typical car idle speed) much less power. As an example: Used Permanent Magnet DC motors that came out of 2400 ft Reel to Reel tape drives of the mainframe era are plentiful in surplus electronic yards and sell for about \$5-10. I think the technical challenge will be to adjust the rotor diameter and your blade construction technique such that you get the maximum RPM you can. This is without it tearing apart from centrifugal force. All most all DC motors and car alternators are designed to operate at well above the typical 100 to 300 RPM that one can get out of a good well balanced windmill. This brings us to another possibility: By use of pulleys and belts or gears the speed of the rotor can be matched to the speed needed to properly drive the generator. This can get complex. It would be nice to not have to use these. I hope you can do it without this complexity.

Offered by [Mike](#).



Troubled Times



Doable

Blades, (length, area, root, chord) hubs, gear ratio, rotor diameter, generator size, amps and volts, and most importantly, "what is the annual average wind speed at your location"? I can't tell you what size rotor diameter without knowing this, along with the generator type, (optimum rpm, volts of at least 14, and amps of 90 or above is recommended). These is your most important criteria. The success of any wind project is dependent upon all these factors. Sure, you can bolt some plywood and 2x6's to an auto hub and make a little electricity but for what? What are your power requirements? What are your plans? What do you have to work with? What are your skills? Will it still be operational in 2 years?

If you don't possess all the skills required, don't despair! A machine shop work is way too expensive for most of us. If we need a specialty item fabricated, we go to our local high school shop teachers. If you let them know what you want to do, they are usually tickled pink to help. Why? Because it's educational, and getting involved with young people is also a civic duty that we should all take seriously. If you have good drawings some young enterprising students will most likely jump at the opportunity to work on a wind generator. It's Great! You furnish the materials and they do the work. You might offer to have them over for a good barbecue when your project is up and running, so that they can enjoy watching their labors at work.

Yes, it's true! You can build a very reliable, and fairly efficient wind generator from used auto parts. We do it quite often. For a reliable 1250 watt machine (modest but useful) using used auto parts plan on spending from \$150 to \$250, that's bolts, nuts, belts, pulleys, bearings, generator, or alternator, tower, just about everything. Even here there will be places that you can cut some of your cost. This is why only 8-10% of the people that contact us continue a dialog. In today's society everyone wants instant gratification, if you want reliability and efficiency you have to work for it. It's not that hard, but for some reason people seem to get scared off.

Offered by [Jay](#).



Troubled Times



Savonius Rotor

Mr. Ken Sulman's *Savonius Rotor, the Alternative Windmill* is a good tutorial about Savonius Rotors and their practical applications. This one has an automotive differential attached, pumping water for his fruit orchard, and could be used to drive a multitude of machinery. The pictures take a while to load but it's well worth the wait! Remember, Savonius Rotors are high torque, low speed turbines, and simple to construct.

Offered by [Jay](#).



Troubled Times



Lawn Mower

If a large Lawn mower wheel is used with a bike generator then it will be capable of charging small Nicad batteries. To get DC the bike generator outputs 6 Volt AC into a bridge rectifier (can be purchased at Radio Shack). For the Propeller use 3-4 blades 4 ft long molding from a lumber yard mounted on a circular piece of plywood. This is then mounted onto the lawn mower wheel. To allow faster rotation in light winds, mount each blade with a relatively smaller angle made with respect to the mounting plywood. Use a mower axle or shoulder bolt of proper size. **Warning: Props are Dangerous! People have lost arms, legs, heads, etc. Keep them high above the ground or put a fence around them. Curious kids and pets could die.** You can't see the prop when it's running. The large tire and the small wheel on the generator produces a gear-up ratio making the generator turn faster than the propeller. It can be built for \$50 or less.

Offered by [Darrell](#).

Sketch by [Mike](#).

Tire-wheel Windmill

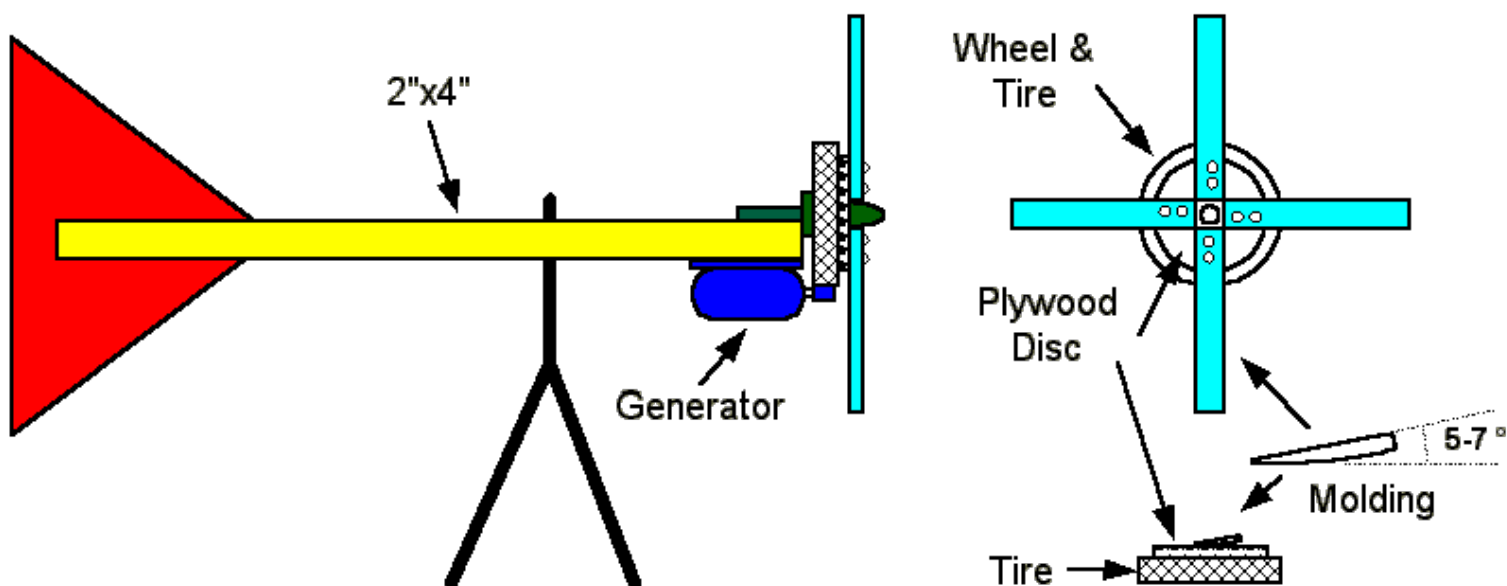

Troubled Times



Wind Gauge

Edmund Scientific has wind gauges. Also, you could take a PM (Permanent Magnet) motor and mount a small hand carved prop on it and put the output wires into a panel volt meter. They will put out a DC voltage when you spin them, so, they can double as a generator. To calibrate it to mph wind speed hold it out a car window while a friend is driving and mark the volt meter in 5 or 10 mph increments. That's the best I can offer for homemade. I have been doing a little experimenting and I found an old heater blower motor I had replaced because it was stuck. It was easily repaired. It is of the newer type that is not made to be taken apart, so I worked it a little and it seemed to free up. I shot WD40 in both sides to clean and lube the bearings. Seemed to do the trick. Wired it to a battery and it ran very well. Must have had a bug nest or other dirt in there clogging it somewhat and the garage replaced it rather than messing with it, you know, It came off my wife's '89 LX Mustang. Next, I wired it to my volt test meter and connected my hand crank drill to the shaft via the chuck and cranked it gently and I was able to generate DC voltage. So it is a PM motor as I had suspected. I like the mounting flange around the middle with 3 screw holes for mounting. I think I have a good possible wind generator here.

Offered by [Darrell](#).

Hook it up to a small propeller or a homemade, vertical, small 4-cup type windmill. Good idea you have about how to test it using a car and holding it out the window.

Offered by [Mike](#).

Permanent Magnet motors have a magnetic field created by fixed magnets versus motors with use magnetic fields created by coils with electricity running through them.

Offered by [Educate-Yourself](#).

I would pick up one of those small toy cars that run off a couple AA cells. Remove the little motor, and you have a very small DC generator. I would also go to a hobby store that sells the remote control airplanes and pick up a replacement propeller. The mounting hole will be too large, so fill it up with something that will set like epoxy or silicone. Then drill a hole the size of the generator shaft and superglue onto the generator. I built one of these about 20 years ago and after calibrating the meter it is quite accurate. Actually, you don't need to mark the calibrations on the meter itself. Just make a table. One column is meter indicated voltage, and on each row place the wind speed. I find this method to be very accurate. You will find that the function of voltage to speed is not linear because of the propeller characteristics.

Offered by [Ron](#).



Troubled Times



Battery Charging

There are several options depending upon your ultimate needs and the 400Hz 28 volt generator power rating.

1. To directly generate 120 VAC, you need a 400Hz 28 volt motor of approximately the same power rating as the 400Hz generator. Connect the 400Hz motor to a 120 VAC 60Hz generator to generate normal AC power. I personally don't see this as being something one would want to do with a windmill as you have no power when the wind isn't blowing.
2. To directly generate 12VDC to charge 12 volt deep cycle batteries, all you need is a bridge rectifier and filter composed of a large value capacitor. You would charge parallel groups of 2 batteries connected in series. This would be my personal choice, as the batteries are able to continue to provide power when there is no wind, or not enough wind.

You would need to convert everything you could, like lighting, to 12 volt. Where you *must* have 120VAC you would need either an *inverter* (converts 12VDC to 120VAC 60 Hz by electronics means and is rather expensive), or a large 12DC motor driving a 120VAC 60Hz generator. For a DC motor, look into surplus jet engine starter motors. These starter motors are what was used on the early experimental battery powered cars; one for each driven wheel. Keep in mind that anything that converts to 120AC is going to use up some of your available power from the windmill, converting it into heat which is lost. Therefore, the more you are able to use 12VDC directly, the better off you are.

Offered by [Ron](#).

Rectifying the power to 12VDC to charge batteries sounds the most efficient to me, but from my understanding of AC motors/generators the line frequency they produce is directly related to the number of poles inside the motor (usually 2 or 4 for most 60Hz motors) and the speed at which the generator is rotated. It is a linear relationship - the faster you spin it, the higher the frequency.

Offered by [Rob](#).



Troubled Times



Voltage Regulator

The easiest way I think would be to charge more than one battery in parallel to adsorb the extra current when the wind blows hard. Check the water level in the cells after heavy winds. One could as an alternative, use a voltage regulator off an old car from the days when they were separate from the alternator. However, I think the way these things work is to disconnect the load when the current gets too high. This works as a disadvantage, you may not want the extra speed that could result, as it may tear the blades off. What one needs is a way to dump the load into a resistor when the speed gets too high. I think the cheapest resistor to use is 12 volt light bulbs. We need to think of the easiest way to divert the load to light bulbs when the voltage gets high. This needs to be done such as to not allow battery drain when not charging.

Offered by [Mike](#).

I can use manual methods to regulate the voltage and switch it to various loads, when I really need the thing I will probably have plenty of time to baby sit it. I think I can use one of those wall light dimmer switches with a volt meter and set it to 12.7 volts and put a couple of diodes in line to prevent back running or motoring so as not to drain the battery set when the wind is not enough to generate. The light dimmer is a large rheostat or variable resistor. I would put it in the circuit to vary the output of the generator and view the output with a voltmeter in the circuit and just set the output where I want it when the wind is blowing to produce enough current and voltage to charge a battery.

Offered by [Darrell](#).

You are basically planning to use a light dimmer to trickle charge the battery when the wind is not blowing. Most modern day 120 volt AC light dimmers are based (I believe) on a SCR (silicon controlled rectifier) and are not based on a high powered variable resistor. So I take it you must be talking about a dash board light dimmer out of 12 volt car.

Offered by [Mike](#).



Troubled Times



Battery Banks

Most people with their own wind systems use three banks of batteries. These banks are set up so each bank can be monitored. Having one bank *Charged and In Reserve*, allowing the system some freedom. No single bank is allowed to drop below 65% of it's rated capacity. When such a condition occurs that bank switches or is switched directly into the wind generator's charging circuit. People that have an average wind speed of less than 10 m.p.h. need to look elsewhere for their power. Wind speed averages this low usually mean numerous periods where there will be days without wind. Under these conditions it is impossible to maintain a healthy battery storage system.

A 480 amps charging capacity is inadequate for charging more than three batteries if 60 amps is its maximum rating. The **BOSCH** alternator that was used in for the axle prop has a rating of 40-100 amps depending on speed and a voltage rating of 14. It's actual start-up condition @ 10 m.p.h. was 13.8 volts, 38 amps, 524 watts respectively. As wind speed increases, current and wattage also increase proportionately. In high wind conditions, operational *Dummy Loads* are used. Pre water heaters, DC water pumps for the yard and heating elements in the winter months. We also employ various mechanical devices to prevent overspeed conditions. This is the largest problem with any wind generating system - overspeed. The formulas that we use are intended to take an alternator or generators operational parameters into consideration, that's why when done properly, the work so well.

Offered by [Jay](#).



Troubled Times



Stay Charged

Here's a note that some people are not aware of. An automotive alternator cannot charge a totally dead battery. Why? The term alternator means exactly what it suggests. It produces alternating current, which is converted to DC current through a half wave rectifier mounted inside the casing. It is in essence an induction alternator and requires the field to be energized before it can produce usable current. For this reason when used in a storage type application you must maintain one battery that will not be drained. This is paramount when wind conditions are so slack that no current is produced for a period long enough to drain all of your storage reserves. It's the same principal as saving water to prime the pump.

Offered by [Jay](#).

Jay made a good point about a auto alternator not being able to charge a dead battery because of no energy being available to power the field coil of the alternator. I had considered this fact years ago and then it occurred to me you could use a secondary generator (i.e., a P.M. motor) attached to the drive shaft to energize the field only. You would only use a size of motor capable of generating enough power to energize the field and not much more.

Another idea I had to deal with this is to take the spool of wire in the (rotor) field and remove it, have a machinist turn a copy of the spool out ferrous metal (I think it is aluminum) and magnetize it with a large number of coils of magnet wire wrapped around it connected to a battery of 1.5 to 3 volts. Leave it connected long enough to make it magnetic when you remove the battery. Then you would of course remove the coiled wire and install in the center of the field rotor of the alternator. Now you would have a permanent magnet alternator.

Another solution I thought of that seems to be worth mentioning for comments is this: one of the early versions of electrical lights on a model T Ford was an arrangement of "V" shaped bar magnets all around the perimeter of the engines flywheel. They were attached to the flywheel with one bolt and a couple of washers so the ends of the magnets were at the edge of the flywheel. I know because I removed some of the magnets when I was a child and I wanted a magnet for science class at school. My Dad gave me a couple of wrenches and pointed me to the flywheel. "take them off and you can have all of them". Well they had one coil of magnet wire wrapped on a bolt that served as a "pickup coil". This is also similiar to the flywheel and pickup coil used as ignition of the Briggs engines. So it would be a simple matter in my mind to attach about 8 magnets to the perimeter of the wood disk of our cobbled up windgenerator and wrap some magnet wire around a couple of bolts through a slice of angle iron as a support mounted to the base board and arranged so the magnets pass very close to the pickup coils at 180 degrees to each other and wired in series and then to our controller. Oh, yes, the main drawback on the alternator lights was no one had come up with a regulator to control it and invariably the driver would over rev the engine with the lights on and burn out every light bulb in the car. Had to keep lots of spare bulbs around in the car.

Offered by [Darrell](#).

I have been thinking about using a brake drum off a old large car or truck. I have collected some of the new thin really strong type niobium magnet. One could epoxy these to the inside of the break drum. The magnetic field and centrifugal force of the rotating drum will almost hold them in place without the epoxy. Reverse the north-south direction for adjacent magnets and space them apart. Next one would mount coils near the magnets but fixed on the drum backing plate so as to not turn with the drum or touch the magnets. The coils could be wound special or use two old transformers cut in half. Both half's with it's coil still around the iron core would be used and the 4 half's spaced around the inside of the perimeter of the break drum. If two step up transformers were cut in half then one would have

two pairs of similar windings that could be connected in parallel or series depending on the final voltage needed. One would end up with 2 different voltages and current ratings. One for each pair of transformer sides.

Offered by [Mike](#).

I think the brake drum design has a lot of possibilities, and is worth testing. I would wind the pickup coils on bolts and make them as large as possible (size of wire diameter and the number of windings too) and the same as each other, wire them in series and at 180 degrees from each other. About the spool that holds the field coil in the auto alternators - I think it is aluminum so when the regulator cuts current to the field coils there would be no residual magnetism in the spool as that would interfere with control of the circuit. I may be wrong, but I believe that is the way it was explained years ago. Also there is a transformer that is variable called an autotransformer. It has a large knob in the center and you can adjust the output up and down manually. Something to keep in mind. **Radio Shack** used to sell them but I haven't noticed lately if they still do.

Offered by [Darrell](#).



Troubled Times



Generators

I am an aircraft mechanic and know fully how a variable pitch blade assy works. I have been thinking of constructing a generator out of obsolete aircraft generators, but don't really know how to convert 28v 400hz power to something useable in a house.

Offered by [LeRoy](#).

I know little about aircraft electrical systems but it seems to me they are using a 400Hz frequency because the engine RPM is always very high, most of the time throttle being at least 1/2 open (a guess). But you are not going to be using this generator/motor in an airplane, you are going to be spinning the shaft by some other means. So if you can find out the RPM's that the generator normally spins at while working in the plane, just reduce the RPM's of your windmill by gears or pulleys until you get the 60Hz signal you need. Then a simple doorbell transformer (wired in reverse) will step up your 28V 60Hz AC to 120V 60Hz which is what you are looking for.

Really the frequency of the line current is not that important, the most important thing to look at as far as I'm concerned is the total power output in Watts that you can get out of the windings without melting them down. Power is the real constraint, everything else can be rectified, inverted, whatever.

Offered by [Rob](#).



Troubled Times



Servo Motor

I picked up at a ham swap, two low speed **Servo Motors** that controlled a tape reel, used in an old 9 track 2400 ft reel-to-reel .5 inch wide computer tape drive. They say "permanent magnetic servo motor" and have two wires coming out of each motor.

The way to check the efficiency and whether these things are still operational is to electrically hook them together. Hook the black wire on one unit to the black on the other unit and the red to the red. Then, if one turns by hand back and forth one shaft on one unit, the shaft on the other unit will rotate and do the same motion at the same time. What this is saying is the one unit being turned by hand is generating enough current, as a generator, to turn the other one as a DC motor. One can then do this motion slower until slippage occurs due to not being able to overcome the friction of the bearings. In this way one can get a pretty good idea of the efficiency of these units as a slow speed generator and motor. These passed the test.

The units are extremely sturdily built being 5.75" long and 4" in diameter and have a .65" diameter shaft with ball bearings each end. They have 4 separate brushes in each unit. They have a heavy duty flange with 4 holes for mounting. They came with the hub that clamps onto a reel-to-reel type tape still on the shaft. This is not the capstan motor, this is the one that drives the tape reels. I plan to use the inside aluminum ring out of an old tape reel to clamp-mount it on the hub, then mount this hub-ring unit in contact with an exercise bicycle wheel. The result will charge one 12 Volt battery or possibly two in series. I was told they were designed to be operated at 28 volts. At this time I am not sure how much power can be generated without causing a problem. My cost was \$15 for both.

If the plan was to use these units outside in a small windmill then the housing and ball bearings would need to be made water proofed in some fashion. The model and company that made them are:

Model: E722

Electro-Craft Corporation

1600 Second St. So.

Hopkins, MN 55343

I think other reel-to-reel tape drive hub servo motors independent of brand should also work. Just check them out as noted above before you purchase.

Offered by [Mike](#).



Troubled Times



Alternator

Those of you who like the belt-driven alternator route to wind power might like to check out this [[DragonflyPower](#)] site for yet another set of plans for sale. I like the look of this one more than the horrid steel contraptions I have seen recently. Also it has a tilt-back governing system. I would still recommend using a permanent magnet alternator if you want to get any power in light winds.

Hugh Piggott

This Scoraig Wind one looks more practical than many we have seen in the past.

Offered by [Mike](#).



Troubled Times



Aircraft

I am an aircraft mechanic and know fully how a variable pitch blade assy works. I have been thinking of constructing a generator out of obsolete aircraft generators, but don't really know how to convert 28v 400hz power to something useable in a house.

LeRoy

What you have in mind is interesting. The type of motor that you suggest here appears to be a good choice for your application. It will give you the opportunity to use off the shelf transformers to charge two banks of batteries @ 120 volts each. You will need to rectify the current, but this is done easily. An added advantage is it gives you the freedom of having your battery storage a good distance from your generator. If you are planning to convert the 400 Hz. generator output into 60 Hz. for direct use in your home, that's a different story. You have not mentioned the most important aspects of your generator, it's *Data Plate Rating*. You can convert the output directly into 120 or 240 volts and bring the frequency down to near 60 Hz. electronically. The problem with this approach is that you will loose a great deal of the power (amperage) that is created by the motor itself.

The reason that small commercially available wind generating systems use battery storage is that the amount of potential power can be enormous. It is possible to use two motors, one as generator and one to drive an a.c. generator. Again this approach is plagued with high losses in power with no storage and can only be used when you have adequate winds, as your system would always be under its maximum load. It would appear that you have a lot of things to consider here. Look closely at your data plate, you need this information for all of the computations that are required for reliability. This will give you an idea of how large your wind generator will need to be. I am an old aerospace mechanic myself, this fact helped to encourage me in wind power almost thirty years ago. Once you have a rotor diameter you can go on to proper blade size.

Offered by [Jay](#).



Troubled Times



Lawnmower

Here is a list of some of my thoughts for consideration:

1. If you put 2 bike alternators on the lawn mower wheel you could double your power and the turbine as described would probably handle it.
2. In stronger winds it may max out at 12volts + since voltage is related to R.P.M.
3. I love a product called GOOP. It is best described as a rubber sort of glue. there are different types of GOOP, and my favorite to date is the Outdoor GOOP. I think if you wound cotton cord string on a shaft and soaked it with the GOOP it would be what would work for your alternator on the tire geared-up windmill. It has a couple draw backs that I know. It runs before it cures so it needs to be molded or held in place until cured. Regular masking tape worked for me in a couple of uses. In the case of the motor shaft you might wrap and glue the shaft shaping the stuff to your fancy and then run the motor real slow until it is cured making sure the stuff stays the way you want. You could take the pulley off the shaft and place in a tuna can or other appropriate sized can or what ever (make a dam around it with molding clay) spray the mold with a mold release (lube), and wrap the pulley with string and mold the stuff to the pulley in a vertical shaft position.
4. Build the generator backward running like Jay mentioned, and mount the generator on a shorter 2x4 piece with a large hinge to the front of the 2x4 on a block of wood to raise this piece up some and allow the rubberized pulley to ride on the tire. Place a spring below the alternator attached to the hinged 2x4, to the 2x4 below or the base board. Could use a turnbuckle in conjunction with the spring to get the right feel for the tension of the pulley against the tire.
5. If we look around a little we may be able to find an Industrial wheel of larger diameter and ball bearings that would work rather well in this configuration . If so testing should be started soon. We use several large size wheels with ball bearings at my shop that I think may work well. I think I was looking at a **Northern Hydraulics** catalogue recently and they sell several wheels of which type I speak.
6. If you would want a weather cover you could use a freon tank and cut off the top and mount the tank bottom to the front and open end to the propeller side. Mount this on the base-board and build everything inside, like you would as if the tank wasn't there. I would cut some air holes in the bottom, too.

Offered by [Darrell](#).



Troubled Times



Books

Mr. Hackleman's *Wind and WindSpinners* is a must for the do-it-yourself wind smith. It is full of the pertinent information one is most likely to need. Darrell should pay particular attention to the chapter on Savonius Rotors. From what I have read of his ideas, it would appear that he is looking to produce high torque to grind grain and operate a variety of machine tools. This chapter explains how to construct the rotor from 50 gallon drums cut in half, from top to bottom. This chapter also shows how to place them in a stacked array for better performance and ease in starting. Another chapter shows how to put together a charging system and battery bank for domestic consumption. It's just an all around good book. I have never known of anyone in my field that hasn't read it.

There is another good book that I think you all would enjoy, Hugh Piggot's *Wind Power Workshop*. It has more information about the construction of horizontal axis wind generators, along with blade construction, hub construction, pitch mechanisms, and much more. Mr. Piggot is a tried and true expert on the construction of home made wind generators.

Offered by [Jay](#).

Received a request for a book on how to build your own power source and how to construct your own solar cells, so found the following that might be of use to others.

The *Homebuilt Dynamo* (book - \$50 from England)

This book is a picture-diary of how we build our dynamo, with some practical information and advice along the way for anyone following our steps. The *Homebuilt Dynamo* is not another "do-it-yourself" book, it is simply a careful diary with photographs, detailed working drawings, and text of how I build myself a low speed, low voltage, three phase permanent magnet alternator with internal rectifier diodes which make, in effect, a direct current generator. To avoid that last longwinded description, I have substituted the word "dynamo" which, anyway, I hate to see disappear from the language.

The reader may well ask: why all the fuss over a low speed machine when mass-produced car and truck alternators are available at very reasonable cost? Well, the answer to that is that the alternative power sources such as small windmills, water turbines, and steam engines have speeds in the 100 to 800 range of RPM. To match the power source generally available to these high-speed machines requires expensive high ratio gearing or a complicated maze of belts and pulleys which aren't very energy efficient and require frequent maintenance.

Offered by [Steve](#).

For those working with windmills, [PicoTurbine](#) has a book with plans on building a windmill from scrap parts from cars and such. To quote from the site:

\$14.95 (includes USA shipping), 1993, 30 pages. *All new, Updated!* This all new edition is completely reformatted and packed with new information. Paul Gipe, noted wind expert has even provided a new Foreword to this edition! Now in a big, easy to read 8.5" by 11" format, with 32 completely redrawn and improved figures. This new edition is easier to follow and understand, and has information on building the turbine from easy to find Ford F250/F350

truck parts! It also includes a brand new section that gives spreadsheet formulas you can use to design your own alternator parameters such as voltage vs. current by using different magnets or coil sizes. This booklet presents complete step by step plans for building a 300 to 500 watt wind turbine using junked parts. These plans have been used all over the world to build simple but reliable wind machines that stand the test of time and weather extremes. Unlike other plans of this type you see from time to time, this one is tested and has proven to be a winner around the world. If you want a specific design for a workable wind turbine you can build from scrap parts, this is the book for you.

Offered by [Michael](#).



Troubled Times



Web Sites

Interesting site I've visited are the [Breakdrum Windmill](#) author's home page.

Offered by [Mike](#).



Troubled Times



Woodcrafted

The intentions behind this Project were to be a science demonstration, to collect data on the performance of homemade PM alternators, to show how easy it is to build a windmill from scratch without metal-working tools ... and to be a bit silly. So imagine our surprise when it made LOTS of useful battery charging power! The more cynical folks around here (me) are calling it the "Wood 403"

[Dan](#)

<http://www.otherpower.com>

Shows what can be done with wood, epoxy, a round shaft, magnets, and wire. Shows some of the basics of the alternator principle. Not recommended for a long lasting windmill but could be modified toward that direction. Using ball bearings instead of a wood bushing would help a lot.

Offered by [Mike](#).



Troubled Times



Blade Design

I liked the concise complete presentation of blade design [Formulas](#) as given under "workshop" at this site. And this below is from another list. I found this interesting to understand how the twist of propellers (water or wind or aircraft) is determined.

Offered by [Mike](#).

I noticed mention of the quietness of the whisper 175 in a recent message. I don't know how many folks are carving their own blades, but years of experience in aircraft prop design have shown that the noise comes from curving vortices left by the blade tips. The pressure on one surface of the airfoil is greater than on the other, and the result is a spanwise flow of air around the tip from the high pressure to the low pressure zone. This turbulence causes noise. The greater the loading of the prop surface. Horsepower generated (in the case of windchargers) or horsepower absorbed (in the case of aircraft) the greater the flow around the tip. This is power lost, drag. The result of this is that the last bit of blade is doing nothing to contribute to power output on a windcharger blade, or thrust generated on an aircraft blade. This phenomenon is easily observable when a helicopter lifts off. As the pilot operates the collective, rolls on more pitch, the noise level increases tremendously. A chopper in hover makes a lotta racket. It is also pretty obvious when you hear a high powered aircraft take off. Blade loading is pretty directly linked to noise level, thus oversize blades will do a great deal to reduce load. Obviously if a wind charger is RPM regulated by loading the generator it will always be noisy. The old Jacobs chargers with their mechanical blade governors weren't especially noisy.

*Model aircraft builders are it would seem always at the bleeding edge of aviation. Check out some of their websites if you're curious about the latest and greatest ideas. These guys have for many years been modifying their prop designs, the result being the highly efficient double and triple pitch props. Aircraft props are described by pitch in inches and diameter. Pitch in inches is simply the distance a prop would theoretically screw itself through a solid. It is derived from the angle of the prop at any given point and the circumference at that same point. If for example your diameter at some point on your prop is 24", and the angle of the blade were 45 degrees (unlikely) the pitch would $\tan(45) * \text{circumference}$. Tangent of 45 degrees is 1, and the circumference*

$$(PI * 24) = 75.39 \quad 1 * 75.39 = 75.39 \text{ (pitch in inches)}$$

If the angle were 20 degrees tangent would be .3639 and the pitch in inches would be 27.44. Obviously using this formula in reverse allows you to get the correct angle at any point on a blade to make it operate properly along it's length. This is how twist is calculated. If you are optimizing for a wind speed of 10 mph you must translate that into inches per minute and calculate pitch accordingly.

$$10 \text{ mph} = 52800 \text{ feet per hour} = 880 \text{ feet per minute} = 10560 \text{ inches per minute.}$$

If you then decide you want a prop RPM of 900 you divide by that figure and the resulting geometric pitch is 11.73 inches of pitch. The issue of sound reduction was where I was headed if I remember correctly. Since your outer 3 or 4 inches of blade are doing nothing anyway due to the spanwise flow, the dodge modelers have used is to reduce pitch in this area. If you reduce the pitch here to where the tips are not trying to develop power, then the spanwise flow diffuses over the trailing edge as there is no pressure differential between top and bottom of the blade at this point to keep spanwise flow going. The result of

this is improved efficiency and quietness. The same technique more or less is used on some aircraft wings and does the same thing as the little winglet you see on some aircraft. One would expect that reduced pitch would reduce the power produced by a blade, or the thrust if we were talking about aircraft, but this is not the case. The efficiency actually improves.

If you are interested in spreadsheets which cover pitch as related to wind speed and RPM, and spreadsheets that will allow you to calculate the blade angle at intervals along it's length for a given pitch, I have downloadable spreadsheets on one of my web pages. It should be noted that these spreadsheets are set up for aircraft propellers, though they can be easily modified to give the results we want for windcharger props. The pitch/angle chart and the airspeed/RPM/pitch chart were originally made up for windchargers. Nothing is locked. To get the desired results simply change the row and column figures to reflect the RPM and airspeed you are designing for if they are not shown. Excel format.

[Stone Tool](#)

owly@ttc-cmc.net



Troubled Times



Downwind

Simplicity is always the key to reliability. Due to the fact that you have no overspeed control you could simplify things by making the generator a down wind machine. Don't worry about *Tower Shadow* it's mostly hype. If you look at pictures of the D.O.E.'s big MOD'S 1, 2, and 3's you'll see that they are all downwind machines. These machines were originally developed by N.A.S.A. and a great deal of wind tunnel tests were performed. They discovered that the stationary tower created less vortex vibrations than a machine with blades moving upwind from the tower. Now we have to use some common sense here. You wouldn't put this little generator on a 1 foot diameter tower either. Many of the worlds most successful machines are downwind configurations.

Just remove the tail, turn the blades around so that they rotate in the proper direction. Set them so that the blade tips are out from the hub about 3-5 degrees. The wind will arrange the rotor properly and you will have less *Yawing* created by the blades vortex traveling around the tail. This is a problem that plagues many small commercial turbines that have no yaw dampening device. There is an added benefit to this approach, your turbine will operate in lower winds. The rotation of the hub, just for the sake of argument lets say counter clockwise, will drive the rotor slightly to the left, about 7 degrees or so depending on wind speed. This phenomenon increases the angle of attack of the blades in relationship to *Apparent Wind*, thus creating more lift and more available power.

Offered by [Jay](#).

Excellent idea, I like it. Simplifies the design. Could use a small low wind resistance counter weight to balance the weight of the generator, instead of the tail fin. The lawn mower wheel itself tends to block the wind and will naturally swing around to a down wind condition.

Offered by [Mike](#).



Troubled Times



Overdriven

The power available in the wind is proportional to the speed of the wind cubed. As a particular alternator spins faster it produces more current. I have never seen or heard of a DC wind generator or a giant MOD-1 wind turbine coming to a halt because it's load was too great. I'm sure that many home experimenters have had this problem. It's most likely because they did not have access to the proper formulas and design materials.

The first component to fail in a small wind generator or a massive wind turbine is almost always the generator. Why? Because they are overdriven during high load conditions, they simply burn themselves up! Even in the big wind turbines the alternator, usually a three phase asynchronous motor of varying size, is the most inexpensive component. Throughout the wind turbine industry they are considered to be expendable items, they are easily rewound. Here is the formula for the power that is available in the wind. All wind formulas are in meters.

Power $P = .5 * d * A * V^3$ where,

P = is the power in the wind

d = is the density of the air @ 1.22kg./m³

A = is the swept area of your rotor

V = is the velocity of the wind in m/s, meters per second.

When using these formulas don't try to convert the variables in the formula, it wont work. Convert the answers.

Offered by [Jay](#).



Troubled Times



Alternator

Most wind units (home made especially) are designed to be efficient at some what low wind speeds. This means when the wind blows strong it could exceed the power rating of the alternator. If the wind blows over say 40 MPH then some other power management is needed to regulate speed or it will burn out the alternator. I can see this to be a problem that will plague all of us. How to get the maxim power without burnout. A good simple recommendation will be needed to handle this. A circuit breaker that cuts out at maximum amperage would save the generator windings. However, it would allow the unit to over speed and possibly fly apart from centrifugal force. Thus, I think one way is to turn it out of the wind in the these cases.

Offered by [Mike](#).

Leave the emergency brake cables attached to the brake hubs. This is the main reason we use the rear wheels of a front wheel drive. One is that you don't have the axle to deal with. The other is the emergency bakes can be used in several ways. First you can arrange a cable to the ground and lock down the hub. The second is that you can use cables during high wind conditions to yaw the generator out of the wind appropriately while still allowing it to run, preventing an overspeed condition.

There are some dangers here. These cables must not be allowed to get in touch with the rotor in any way. What we usually do is place a steel ring of 8 - 10 inches in diameter about 4 ft. above the ground on the side of prevailing winds. Any cables that you use must be weighted enough so that the wind will not entangle them with the rotor. Attach one cable to the front of a downwind machine to allow you to yaw the machine around. Attach the other cable to the brake cable of the yaw hub. All cables are left within the ring. When you get the machine in proper alignment lock down the hub. You have to use some common sense here, creating a proper spring tension device to keep the brake deployed. You can use a similar technique to lock the rotor also. I use several different automatic overspeed controls that are driven by the machines own rotation as fail-safe devices, they are a little more sophisticated, using flyweights and such.

Offered by [Jay](#).



Troubled Times



Balance

I have experimented with several types of auto alternators and generator (old VW) and have found that there is a large variance in amperage produced by different makes. Forget car alternators and find one in a schoolbus or similar vehicle that requires an industrial battery, like tractor trailers, heavy equipment etc. The one I use came from a 1985 bus and produces 160 amps at the same general rpms as most 30 amp car alternators. Do you see the advantage here? Lots more power at same speeds, gear ratios etc., plus most can endure rougher treatment because they are built to take more vibration, etc.

Offered by [Woodie](#).

The greater the amount of current drawn from a generator, the more energy required to turn the generator shaft. Whether using pedal-power, wind, or water, the more load (current) placed upon the generator, the slower the pedal or blade will turn with a fixed wind speed, water speed, or effort on the pedals. Therefore, it does no good to put a 100 amp generator into service over a 60 amp generator if the power source is only capable of producing 480 watts (12 X 40). This should be of primary importance in designing a pedal driven system. A wind driven system can be slowed to a halt if it has a large generator and is charging enough batteries at the same time. You can actually regulate maximum blade speed by adding and removing batteries from the parallel connected battery bank.

Offered by [Ron](#).



Troubled Times



Old Fashioned

The best place to research old plans is *Popular Mechanics* from 1900 to 1950. (If you can find a good old library that didn't pitch them.) Reprints are available in paperback book form called *The Boy Mechanic* vol 1, 2 and 3. Lindsay of Chicago also has the manual for sale.

Lindsay Publications Inc.

Po box 538
Bradley IL 60915-0538

815/935-5353, Fax 815/935-5477

The best old manual still available for plans on carving props and several windmill plans is the *LeJay Manual* (1945).

LeJay Manufacturing Co. Inc.

Belle Plaine, MN 56011

Offered by [Darrell](#).

Before you consider the construction of your own wind power devices you should read the *LeJay Manual*, published by Lindsay Publication. I just ordered a new one, as mine is very old and tattered. Lindsay wrote:

Do you still carry the LeJay manual? If so, how much in U.S.
Many Thanks

Jay Mullin *The Wind Works*

The cost of the LeJay Manual is \$8.95 plus \$1.25 for shipping. If you send us your address, we will send you our catalog.
Thanks

Margaret at Lindsay Publications

Offered by [Jay](#).

As my Danish friends say, "Goot Windkraften"



Troubled Times



Nebraska Windmill

I had a book no longer in print called *Windmills of Nebraska*, which was very good. Loaned it out and never got it back. It was a reprint of a 1880's manual put together by an agricultural agent who was fascinated by the ingenuity of the local farmers and their homemade windmills. In the 1950's when I grew up there were many working around the neighborhood. The Nebraska Windmills, Circa 1870, originated in the middle ages centuries ago. They were used in castle towers for the purpose of pumping water. They had bucket pump type systems that was a continuous chain of buckets on a rope type belt that dipped into a well or cistern and on up to pour into a water tank run over wood pulleys. Another major use was grinding grain into flour. They were also used to power tools, shops, and electric generators.

To shut down the windmill you can apply a break system to one end of the axle or enclose the windmill with doors that can be opened to allow wind through, or shut to stop the wind. It doesn't work only in one direction, it works in about 6 angles, but half of the time rotation would be in reverse, which doesn't matter if you're grinding grain or pumping water. Most of our wind is prevailing westerly. If the axle runs north-south, it won't work in north or south winds.

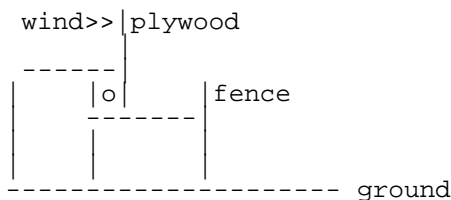

They would be cheap and easy to build from scrap lumber with a little imagination. The paddles could be as simple as 2x2 board frames covered with cloth like canvas, etc., which would cut costs. Could use a 8 ft. 4 x 4 for the axle. Mount 2 steel shafts on the ends where it will mount in bearings. Use a pipe flange and a nipple at the center of each end. Insert a round steel shaft in each end long enough to clear the pillow block bearings needed at each end to mount the shaft and take off power by a large pulley or crank. You can put one on one end and one on the other. (this will run at around 300 rpm). Mount a 4' by 8' sheet of plywood on each side of the axle shaft to form a turbine. Then you will need a board fence all around the windmill from the ground to the axle, so the top blade of your turbine will be exposed to the air. Also, note that the bearings are mounted each on top of posts.

A model (working) could easily be made with a card board box. Make the turbine to fit your box. That would be a good way to test it. Held together with bolts and balanced so as to not fly apart under high wind conditions. Don't nail it together it will soon fall apart if you do. I estimate about 200 dollars to build it.

Offered by [Darrell](#).



Troubled Times



Sails

This design in the quote below is a vertical mount windmill using sails, and seems pretty practical. One of the problems I've encountered with horizontal mount windmills is the fabrication problems for the blades. If you need to replace a broken blade this becomes a problem, getting the proper shape, pitch, etc. If you're working with sails finding material should be easier, particularly post pole shift.

Richard Pierson wrote a book back in 1978 which I kept a copy of. It is entitled "Build-It Yourself Natural Energy Sources: Solar, Wind & Water Power Made Easy" Chapter 10 of that book describes in great detail how to build the Vertical-Shaft Pierson Wind Turbine. I basically a modified S-rotor system with aluminum or galvanized sheet metal scoops or half-cylinders as rotors, but it also has these neat stationary vectoring vanes to scoop up even more wind into the rotor. These are really just fixed walls pointing at a tangent to the rotor buckets. He calls these fixed walls stator vanes, or just stators. That is the best part of this design, I think because it allows the configuration to begin putting out power in 5 MPH winds or below, depending on the length of the stator (wall) from the vertical shaft out to the end of the stator. You have to rig up a generator and some gears, and for high winds you might have to figure out how to shut it down or rig up a governor, but it looks do-able for a tinkerer like myself.

Here's some more info on vertical axis wind turbines/mills. Think greenhouse pumps and fan power, and heat, and chillers, etc.

<http://www.greenwindmill.com/>

<http://www.windmillworld.com/links/verticalaxis.htm>

<http://www.southcom.com.au/~windmill/>

<http://home.earthlink.net/~fradella/green.htm>

Offered by [Stan](#).



Troubled Times



Ground Level

A few years back I looked around to see what windmills (primarily water pumps) were still up working. I remember one that was up 80+ feet and it stood well above the farm buildings and trees and the owners always had a hard time getting the help to climb the steel tower (I believe it to be a commercial Areomotor) and check the gearbox and add oil if needed. They would offer a day off with pay. Sometimes it went long periods unchecked. It was still there then, working. It never blew over in storms. I wondered why. Now I know. Ground turbulence causes destructive forces. It is high enough to be above that. Also something I learned climbing telephone poles in Viet Nam - when you get up 80+ feet on a still day there is a breeze up there. So all the better reason to go 80+ feet with a tower.

The Nebraska type is at somewhat of a disadvantage there since it is usually on the ground. But, they were built on and in buildings at the top floors also, but of course at more expense. One much resembles a merry-go-round of the kind found in school playgrounds in the 1950's, the one where the kids kicked the ground to make it go around in a circle with kid power. The better versions built in buildings did have shutters or sliding doors with which to shut off the wind to protect the mill during storms, and a water tank above so the same building served as a water tower as well so that water could be piped under pressure.

Offered by [Darrell](#).



Troubled Times



Sketch

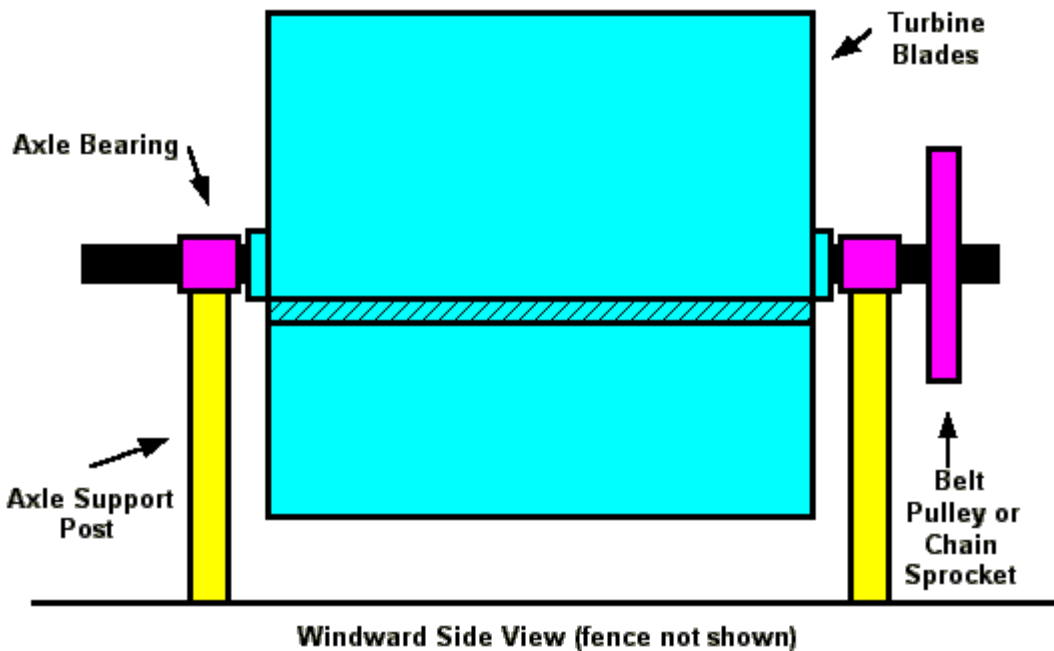
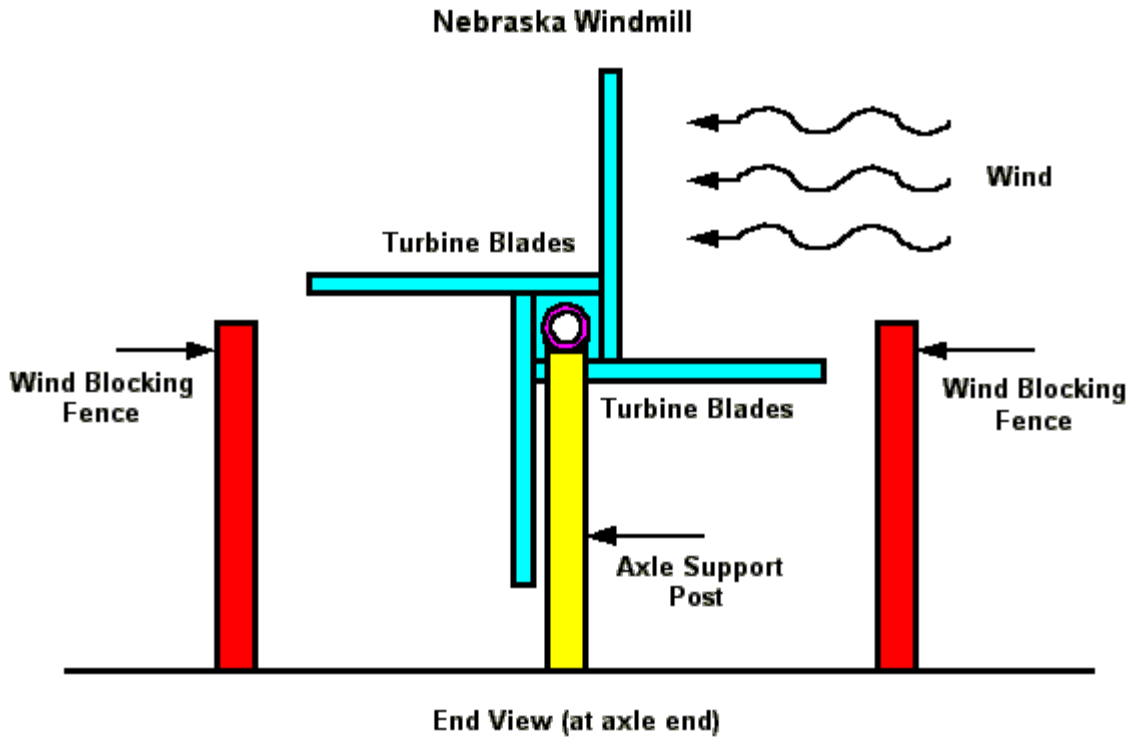

Sketch by [Mike](#).



Troubled Times



Problems

A working model of the Nebraska Windmill could easily be made with a cardboard box. Make the turbine to fit your box. That would be a good way to test it. This should be held together with bolts and balanced so as to not fly apart under high wind conditions. Don't nail it together it will soon fall apart if you do. I estimate about 200 dollars to build it.

Offered by [Darrell](#).

I took your idea on using a cardboard box to test out this concept. I stapled four blades of 8x16 inches to simulate four sheets of 4x8 feet of plywood to a 1/2 inch dowel, each 90 degrees apart. I then took two 2x4's and drilled a 5/8 inch hole, centered 8 & 1/2 inches from the bottom of each. Then I stapled one of the 2x4's to each end of the box, which was my bearing, crude but useful here. Before inserting the main shaft and blades I drilled two holes in the dowel, where I used washers and cotter pins to prevent lateral movement, and then coated the ends as well as the holes with axle grease. I have a small infrared tachometer that I use often here in my work. I attached a small stick-on reflector to one end of the shaft, set up my tachometer and waited for morning.

In an 18 mph wind at ground level we saw 22 rpm, not good at all! Then I thought "remove the back of the box" to lessen impeller impedance created by dead air in the box itself. Remember Newton's Law about an object at rest? Air is a fluid, and as such has all of the characteristics of water, just in a smaller degree. A cubic meter of air weighs in at about 2.34 kilograms per sq. meter at sea level. That's 5.24 lbs. per 1.3 cubic yards. The results were improved - in the same wind we saw an increase of 6 rpm at 28 mph. In my opinion this approach is not useful at all, especially when you can't yaw it into the wind. Also wind speed at ground level averages about 28% less than at 60 ft.

The problem here is there is no lift being created, only drag. It is only "drag" that moves the upward vane in the direction that the wind is blowing, while the same "drag" in smaller amounts impedes the free rotation of the others.

Offered by [Jay](#).



Troubled Times



Home Made

I am *no* expert, but my thought was to gather some useful information so that anyone (even I) could make a 2-blade wind turbine even after the pole shift. This will take into account the following requirements:

- With a well built wind turbine 30-40% of the wind's energy can be accumulated.
- A normal house needs about 15,000 to 30,000 kwt (kilowatt-hour) per year.
- For that, one needs a power source that would give 1-2 kW. This is like having one or two moped motors on full power at all times.
- The wind is essential, and the greater the wind power the greater the energy.
- With a wind of 5 m/s (meters per second) the diameter of a turbine should be about 10 meters to capture the amount of energy for a normal house. This would be about 2,198 Watts.

In CAD/CAM Autolisp (programming language) is used for making specific applications such as calculation programs, etc. The Lisp language is structured to handle non-numeric symbols in a logical way. The document I have has the name **Autolisp Programmed 2 Bladed Turbine**. The turbine is based on some parameters, which you probably could get in any book about wind turbines, concerning the form and shape of the wing. In this material I have, a specific wing is already chosen, and one only needs to have an Autocad program or some kind of paint program to plot out the wing profile to make a blueprint. You could make it as big or small as you wish.

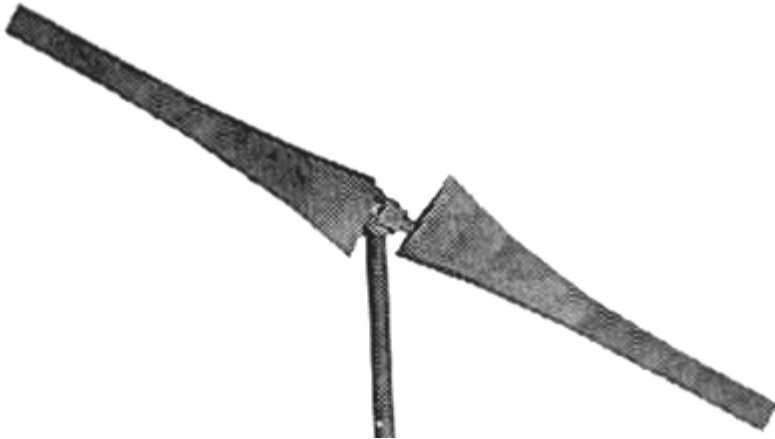

One could use:

- Wood, plywood or material similar to polyurethane foam, something that you could form with ease in the making of a blueprint
- Old car parts, for the wing turbine
- A large generator or a couple of old car generators
- A power cable of some sort from the generator(s) to a battery room.

One turbine, two old car generators and some car batteries could give enough power to have more than a few lamps shining in your hydroponic garden for a long time.

Offered by [Geson](#).



Troubled Times



Factors to Consider

The effect gathered from the wind depends on several things. The following things are to be considered:

Blade Diameter

- A big blade needs a big base structure and vice versa. If the wind speed doubles the effect is increased eight times. With a well built turbine one can get 30-40 percent of the wind's energy. This means that the wind velocity has been decreased by 1/3. Wind velocity is of great importance. The energy that one can gather from the wind increases by the velocity of the wind measured in cubic.

Shape on the Blade (fast runner or other)

- The blade needs to be constructed in special ways depending upon how much of the wind one wants to catch. The blade has to work with the wind. The force has to be equalized or the blade wing would work against itself and could brake too easily. Different shapes have their own specific parameters to be considered. First determine how large a blade you want, then make the blueprint by plotting out the wing cm by cm. I've included the parameters on the wing profile page.

Type of Generator (2-15 kW or more)

- Magnetic braking or automatic resistance? If the wind gets to high then the turbine could be automatically braked to stop it from rotating or one can manually pull it down to the ground until the wind has decreased.
- Is the generator by itself or is the turbine integrated with the generator? Some constructions work better to using 5 meter/s and others work better at 20 meters/s.
- What kind of gearbox do you want? This is dependent upon how large or small the turbine is and how much energy you want to produce.
- Do you want a steady flow at 230 watts AC? Then you need to have a generator that can make 3000 rpm (revolutions per minute), which is needed to get a sinus wave at 50 hertz (this is to generate the magnetic fields in AC). That's normal in Sweden anyway. You could get more or less out of the turbine by choosing the right generator, gearbox and number of revolutions.

Transformer / Regulator (what kind of energy do you want?)

- Direct current (DC) or alternating current (AC)? AC generates magnetic fields that is needed for many (or most) electrical devices like TV's and the like. DC can be used if you only want to have a couple of light bulbs running. There are many machines like electrical heaters that can use DC, and if not, they can be converted with some minor mechanical skill.
- Are you going to use a water heater? One can direct the motion energy from the turbine into some kind of a water tank to generate heat by friction. This heat can be directed to a water heater via pipes and other elements. Heat directing can be done without water as well by directing the friction energy or heat in a rubble of stones.
- Store the energy; how? DC can be stored with batteries, but AC can't. If you want to have AC then you need to

have a generator that can produce it. If you want to store the energy, then you need a charger that can regulate the energy going into storage. There is always some energy loss within such a system.

Offered by [Geson](#).



Troubled Times



Supplies Needed

This is what you need for a Low-Tech turbine:

- Pencil, eraser, rulers and paper (millimeter paper)
- Patience; no skill is needed as you will learn by trial and error
- Plywood or any other material that will make a good blueprint
- Wood planks or/and metal parts from a junk yard that are easy to work with
- One or more car generators (2-6 kW capacity)
- One or more car batteries (12v) or a truck battery (24v) or any other
- Cables
- In cold climates you might want to connect to a water heater
- A Switch box from 12 or 24v to 220w AC

Add this to the list if you are making a High-Tech turbine:

- A Computer (at least a 386 PC or a 68040 Mac with a math processor)
- Some kind of paint or cad program (ACAD) to plot the wing profile, and a printer.
- A large generator (4-20 kW capacity) with a gear box that can make 3000 rpm
- Regulators for AC and DC
- Recharger for batteries

How much material you need depends on how large a turbine you want to make. I suggest that you start by making a small turbine about 2 meters in diameter. This is to get the hang of it. Today you can still buy anything you need in a store or in the junkyard, but after the pole shift will be to late to shop. If you start with a small turbine the next, a bigger 10 meter turbine, will be much improved by your newly learned knowledge and skill.

Estimated cost: It depends on if this stuff is new or not!

- Generators 2-6 kW: \$100 - \$1,000.
- Generators 4-20 kW: \$100 - \$1000.
- Batteries: \$40 - \$800.
- Wiring, cables: ?
- Regulators: ?
- Recharger: ?

Offered by [Geson](#).



Troubled Times



Wing Diameter

If you start by making a 2 meter inch diameter turbine the calculation is as follows:

- Surface is called A=Area
- $\pi=3,14$
- r =Radius
- r^2 =Square radius ($r \times r$)

The radius for a 2 meter turbine is 1 meter, and to know what effect we can get from this turbine we need to know its working area (WA) in square meters.

- $(\pi \times r \times r = WA \text{ m}^2) \implies 3,14 \times 1 \times 1 = 3,14 \text{ m}^2$

If the wind velocity is 5 m/s (as in the table above) the effect is about 80Wm² (Watts per square meter). You get approximately 1/3 (0,35) from the Natural force which should give an effect of about 80 Watt using this small 2 meter turbine

- $(80 \text{ Wm}^2 \times 3,14 \text{ m}^2) \implies 80 \times 3,14 = 240 \text{ W}$

Offered by [Geson](#).



Troubled Times



Natural Force

The purpose of this project is to cover one's need for energy, with the wind as a power source, enough to provide for a normal family home. In this example we have a 2-blade turbine with an advanced aerodynamic shape, a so called fast runner, to convert wind energy to kinetic energy. This type of turbine is ideal to use in combination with electric generators due to it's high rotor speed, which can be chosen so that the motion of the tips of the propeller blades becomes 8-9 times faster than the motion of the wind.

About 15,000 - 30,000 kWh per year is needed to heat a house, depending on where the house is located. This would be as much as having two moped motors going full force, hour after hour, continuously. With a well built turbine one can get 30 - 40 % of the wind's energy. This means that the wind velocity has been decreased by 1/3. Wind velocity is of great importance. The energy that one can gather from the wind increases by the velocity of the wind measured in cubic. The degree of efficiency in this example below gives an effect of 2,198 W.

Natural force (kpm/s) per square meter	$N = P \times V$
Force (kp/square meter)	$P = 0.064 \times V^2$
Effect (kpm/s)	$N = 0.064 \times V^3$
Recalculated to w	$N_w = 0.64 \times V^3$
Wind velocity 5 meters/second	$N_w = 0.64 \times 5^3 = 80 \text{ W} / M^2$
Turbine diameter - 10 meters: Wrapped surface 78 square meter Wind force: 5 m/s	$N_w = 0.64 \times 5^3 \times 78 = 6,320 \text{ W}$

If you have trouble understanding this kind of math, check the page on how to calculate the output of the natural force of the wind. The larger part of Sweden has a normal wind velocity at 5 m/s or more, at an acceptably reachable height. In Sweden there will be enough wind for a 10 m turbine. The wind also blows more in the winter than in any other season.

Offered by [Geson](#).



Troubled Times



Output

This is a calculation of the wind velocity; the effect in Watt per square meter of a turbine (used in this document). To know what effect you will get with a generator you need do some more math:

- 08 m/s ==> $N_w = 0.64 \times 08^3 = 0,328 \text{ Wm}^2$
- 12 m/s ==> $N_w = 0.64 \times 12^3 = 1,006 \text{ Wm}^2$
- 14 m/s ==> $N_w = 0.64 \times 14^3 = 1,756 \text{ Wm}^2$
- 18 m/s ==> $N_w = 0.64 \times 18^3 = 3,732 \text{ Wm}^2$

This is a calculation of the effect in Watt for the 2 meter turbine (3,14 m²):

- 08 m/s ==> $0,328 \times 3,14 = 01,030 \text{ W}$
- 12 m/s ==> $1,006 \times 3,14 = 03,159 \text{ W}$
- 14 m/s ==> $1,756 \times 3,14 = 05,513 \text{ W}$
- 18 m/s ==> $3,732 \times 3,14 = 11,718 \text{ W}$

This is a calculation of the generated effect (1/3 of the natural force; 0,35) in Watt of a 2 meter turbine:

- 08 m/s ==> $01,030 \times 0,35 = 0,360 \text{ W}$
- 12 m/s ==> $03,159 \times 0,35 = 1,106 \text{ W}$
- 14 m/s ==> $05,513 \times 0,35 = 1,929 \text{ W}$
- 18 m/s ==> $11,718 \times 0,35 = 4,101 \text{ W}$

This is a calculation of the effect in Watt per squaremeter of the 10 meter turbine (78,5 m²):

- 08 m/s ==> $0,328 \times 78,5 = 025,748 \text{ W}$
- 12 m/s ==> $1,006 \times 78,5 = 078,971 \text{ W}$
- 14 m/s ==> $1,756 \times 78,5 = 137,846 \text{ W}$
- 18 m/s ==> $3,732 \times 78,5 = 292,962 \text{ W}$

This is a calculation of the generated effect (1/3 of the natural force; 0,35) in Watt of a 10 meter turbine:

- 08 m/s ---> $025,748 \times 0,35 = 009\ 012 \text{ W}$
- 12 m/s ---> $078,971 \times 0,35 = 027\ 639 \text{ W}$
- 14 m/s ---> $137,846 \times 0,35 = 048\ 246 \text{ W}$
- 18 m/s ---> $292,962 \times 0,35 = 102\ 537 \text{ W}$

Offered by [Geson](#).



Troubled Times



Wing Width

When the radius of the turbine is chosen the width of the blade is then measured based on different aspects of the radius.

b = Blade width

R = Turbine radius

r = Radius of respective blade element

z = Number of blades

Ca = lift force coefficient by r

lambda = Rotor speed

$$b = \frac{5.6 \times R}{Z \times C_a \times (r/R) \times \lambda^2}$$

Thereafter the marks of every momentum point for the respective profiles is measured. The momentum points are 1/3 out on the cord measured from the profile end. A practical way to proceed is to place all momentum points on a straight line through the whole turbine. In Acad you can draw a line from Origo, with length and angle equivalent to 1/3 of the longest wing profile. Then draw lines from that end point with the length of 1/3 of the other wing profiles but with their respective angles, 180 degrees, straight opposite to their original direction.

Now you can let Acad identify the coordinates for all the end points. The first line end point is zero (0). If we choose to place the longest profiles start point in Origo, we now have the coordinates for all profiles starting points. These coordinates are fed into the program when it asks for "ucs by radius 1R", together with a "z-value". The 1R is the turbine's whole radius.

Check the wing profile page for more specifics.

Offered by [Geson](#).



Troubled Times



Width Example

Below are examples showing how to calculate the four parts of the wing. There are calculations for both the 2 and 10 meter turbines. This is the calculation for the 2 meter turbine (3,14 m²)

1. First part; the Momentum points are 1/4 out on the cord measured from the profile end.

b = Blade width
 R = Turbine radius
 r = Radius of respective blade element
 z = Number of blades
 Ca = lift force coefficient by r
 lambda = Rotor speed (8-9)

$$0,15 = \frac{5.6 \times 2}{2 \times 0,8 \times 0,75 \times 8 \times 8}$$

The blade width 75% out on the wing is = 0,15 m

b = Blade width
 R = Turbine radius
 r = Radius of respective blade element
 z = Number of blades
 Ca = lift force coefficient by r
 lambda = Rotor speed (8-9)

$$0,18 = \frac{5.6 \times 2}{2 \times 1 \times 0,5 \times 8 \times 8}$$

2. Second part; The blade width 50% out on the wing is = 0,18 m

b = Blade width
 R = Turbine radius
 r = Radius of respective blade element
 z = Number of blades
 Ca = lift force coefficient by r
 lambda = Rotor speed (8-9)

$$0,29 = \frac{5.6 \times 2}{2 \times 1,2 \times 0,25 \times 8 \times 8}$$

3. Third part; The bladewidth 25% out on the wing is = 0,29 m

b = Blade width
 R = Turbine radius
 r = Radius of respective blade element
 z = Number of blades
 Ca = lift force coefficient by r
 lambda = Rotor speed (8-9)

$$0,54 = \frac{5.6 \times 2}{2 \times 1,3 \times 0,125 \times 8 \times 8}$$

4. Fourth part; The blade width 25% out on the wing is = 0,54 m

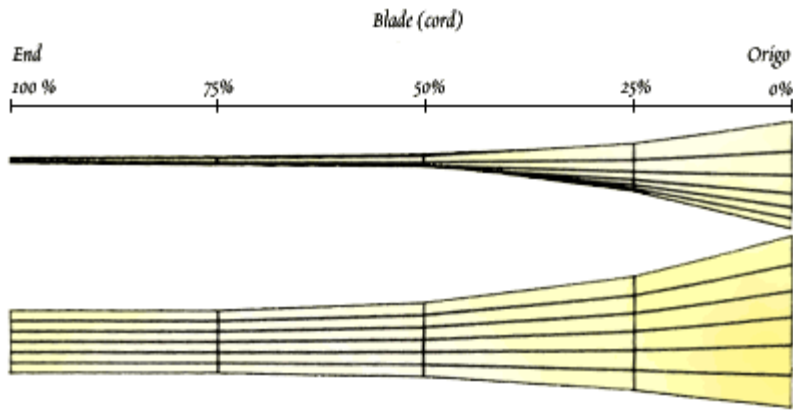

Below: C_a = Lift force coefficient chart

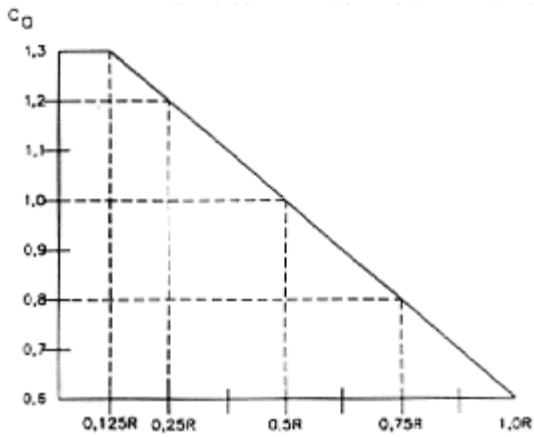

These are the calculations for the 10 meter turbine (78,5 m²):

1. First part; the Momentum points are 1/4 out on the cord measured from the profile end.

b = Blade width

R = Turbine radius

r = Radius of respective blade element

z = Number of blades

C_a = lift force coefficient by r

λ = Rotor speed (8-9)

5.6 = Constant

$$0,35 = \frac{5.6 \times 5}{2 \times 0,8 \times 0,75 \times 8 \times 8}$$

The blade width 75% out on the wing is = 0,35 m

b = Blade width

R = Turbine radius

r = Radius of respective blade element

z = Number of blades

C_a = lift force coefficient by r

λ = Rotor speed (8-9)

5.6 = Constant

$$0,44 = \frac{5.6 \times 5}{2 \times 1 \times 0,5 \times 8 \times 8}$$

2. Second part; The blade width 50% out on the wing is = 0,44 m

b = Blade width

R = Turbine radius

r = Radius of respective blade element

z = Number of blades

Ca = lift force coefficient by r

lambda = Rotor speed (8-9)

5.6 = Constant

$$0,73 = \frac{5.6 \times 5}{2 \times 1,2 \times 0,25 \times 8 \times 8}$$

3. Third part; The bladewidth 25% out on the wing is = 0,73 m

b = Blade width

R = Turbine radius

r = Radius of respective blade element

z = Number of blades

Ca = lift force coefficient by r

lambda = Rotor speed (8-9)

5.6 = Constant

$$1,35 = \frac{5.6 \times 5}{2 \times 1,3 \times 0,125 \times 8 \times 8}$$

4. Fourth part; The blade width 0% out on the wing is = 1,35 m

Offered by [Geson](#).



Troubled Times



Wing Profile

Use the NACA Chart below to make a profile of the wing upper and lower surface:

Upper Surface		Lower Surface	
Station	Ordinate	Station	Ordinate
0	0	0	0
0.431	0.867	0.569	-0.767
0.673	1.056	0.827	-0.916
1.163	1.354	1.337	-1.140
2.401	1.884	2.559	-1.512
4.890	2.656	5.110	-2.024
7.387	3.248	7.613	-2.400
9.887	3.763	10.113	-2.702
14.894	4.514	15.106	-3.168
19.905	5.097	20.095	-3.505
24.919	5.533	25.081	-3.743
29.934	5.836	30.066	-3.892
34.951	6.010	35.049	-3.950
39.968	6.059	40.032	-3.917
44.985	5.938	45.015	-3.748
50.000	5.689	50.000	-3.483
55.014	5.333	54.987	-3.143
60.025	4.891	59.975	-2.749
65.033	4.375	64.967	-2.315
70.038	3.799	69.962	-1.855
75.040	3.176	74.960	-1.386
80.038	2.518	79.962	-0.926
85.033	1.849	84.968	-0.503
90.024	1.188	89.977	-0.154
95.012	0.564	94.988	0.068
100.00	0	100.00	0

NACA 64-210:

- Stations and ordinates given in per cent of air foil chord.
- L.E. radius: 0.720
- Slope radius through L.E.: 0.084

Offered by [Geson](#).



Troubled Times



Profile Example

Upper surface - Station:

- First number, in the upper surface table, is 0, and marked as X = starting point. I am using centimeters (cm) in this example below, and I've made a line that is 100 cm long.
- Put a mark for the second number 4.31 millimeters (mm) from X on the line.
- Third number is 0.673. Put a mark 6.73 mm from X on the line. Do the same with the rest of the numbers in the station table.

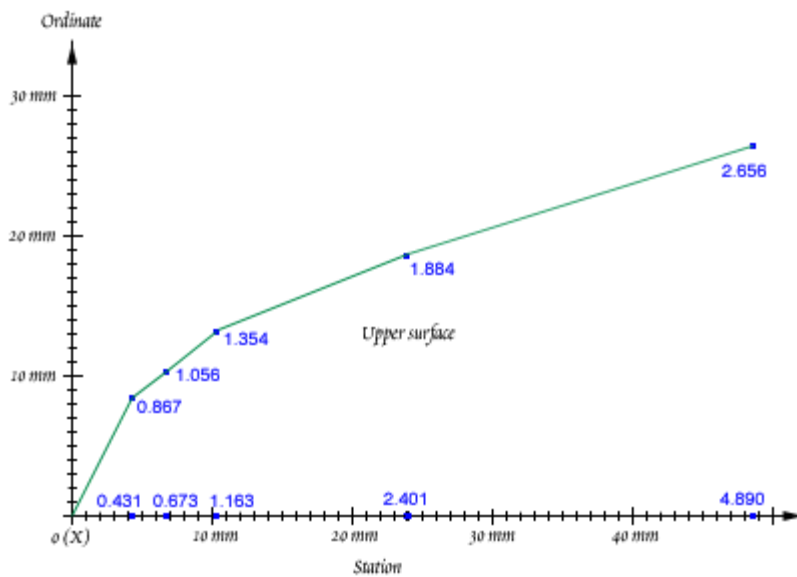

Upper surface - Ordinate:

- Now, to plot the upper surface put a mark, using the second number in the ordinate table, 0.867 above the corresponding number in the station table 0.431. That is 8.67 mm up.
- Third number in the ordinate table is 1.056. Put a mark 10.56 mm above the corresponding number in the station table (0.673).

When you have finished plotted the station and ordinate points, draw a line between X and through all the ordinate marks and voile! the upper surface is ready.

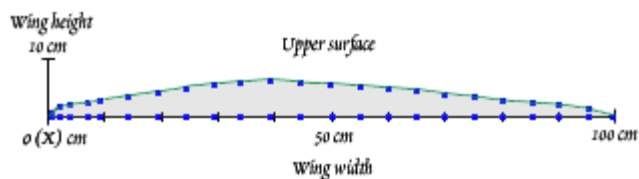

Lower surface - Station:

- First number, in the lower surface table, is 0, and marked as X = starting point.
- Put a mark for the second number 5.69 mm (0.569) from X on the line.

- Third number is 0.827. Put a mark 8.27 mm from X on the line. Do the same with the rest of the numbers in the station table.

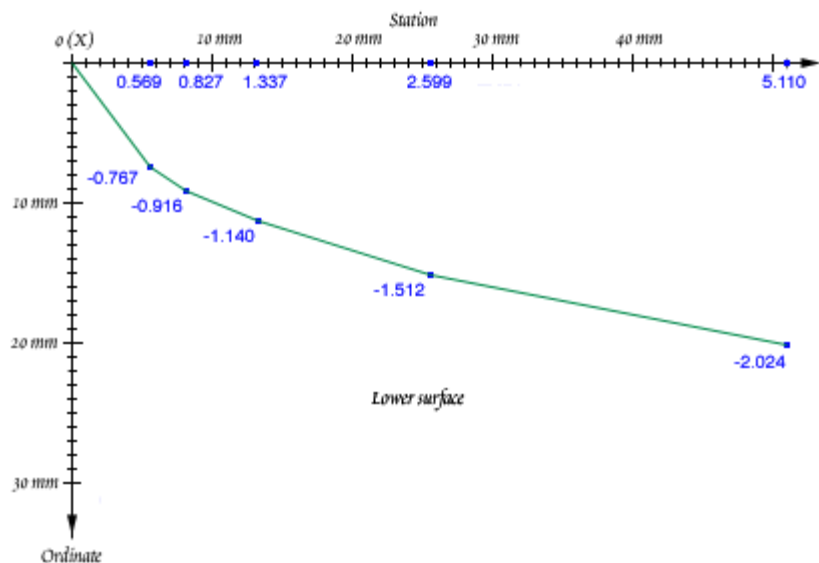

Lower surface - Ordinate:

- Now, to plot the lower surface put a mark, using the second number in the ordinate table, -0.767 below the corresponding number in the station table 0.569. That is 7.67 mm down..
- Third number in the ordinate table is -0.916. Put a mark 9.16 mm below the corresponding number in the station table (0.827).
- When you have finished plotting the station and ordinate points, draw a line between X and through all the ordinate marks and voile! the lower surface is ready.

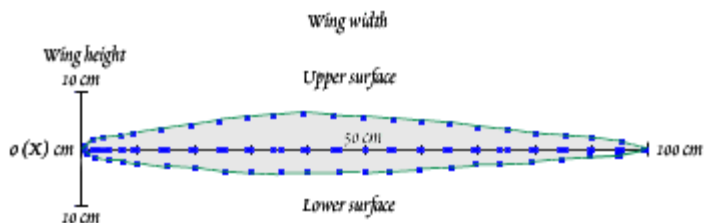

Now you know how to make a wing profile!

Offered by [Geson](#).



Troubled Times



Compare Costs

Gasoline generators can provide power. Each generator cost about \$500 and has a useful life of about two years. It consumes an average of 1.5 gallons of gasoline each day. The annual operating cost is estimated to be \$852. (Assuming gasoline is \$1.10 per gallon @ 1.5 gallons per day, that comes to \$602 dollars per year. Depreciation is \$250 per year.)

A solar electric system providing equivalent power would require an array of 40, 47 watt panels that would operate an average of five hours per day in the average area. This system would have cost in excess of \$12,000! The estimated life of solar electric panels is 20 years. If the \$12,000 installation cost is prorated over the twenty year life, then the cost becomes \$600 per year.

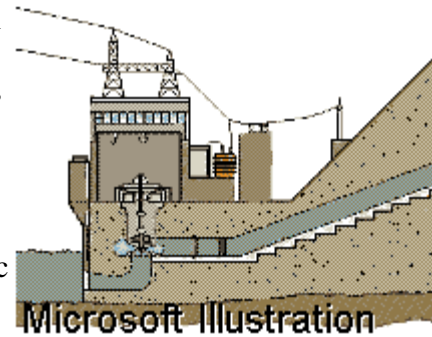

The annual operating costs for the micro-hydroelectric system are very low. The standard V pulley belts must be replaced every six months, this is approximately \$70 per year. Presently, the bearings are replaced each year at a cost of around \$60. The brushes and bearings in the alternator are replaced annually for about \$20. (I have estimated the alternator operates for the equivalent of almost 400,000 miles per year.) The pulley system is replaced every two years, the estimated annual cost is \$25. The total estimated annual operating cost is \$175.



Troubled Times



Model System

The micro-hydroelectric system produces approximately 14 Volts Alternating Current, variable frequency. A modified car Delco car alternator is used. The voltage is increased to 140 volts using a step-up transformer. Conventional battery chargers are used to charge golf cart batteries located at three sites. An A-Frame house (1008 square feet) and the well house are each powered directly by two, six volt batteries, wired to provide twelve volts. Power can be sent to an earth-sheltered home approximately 700 feet away from the micro-hydroelectric system installation.

The electrical system of an earth-sheltered home (1920 square feet) operates from the batteries via a Trace 612 inverter. The six, six volt batteries in the earth-sheltered home are wired in a series/parallel method to provide twelve volts to the inverter.

Offered by [Eric](#).

A caution regarding the reference to an earth sheltered house. If not properly designed the whole thing could collapse because of the tremendous weight of the earth birm sliding over the structure. I would also offer a caution again regarding the reference to 6 volt batteries in a series. Placing batteries in a series like this increases the likelihood of failure as either cell can fail. It is also not advisable to have cells in a series for charging. This decreases efficiency and can cause failure if one cell becomes shorted, thus causing the other to be exposed to excess charing voltage.

Offered by [Steve](#).



Troubled Times



Micro-Hydro

The options for home scale micro-hydroelectric systems are very limited. A few companies will custom design and build a system, assuming you have a high enough head. But their systems are not really designed for the single home site. The price is very high! The *Alternate Energy Source* book published by the **Real Goods Trading Corporation** offers two hydroelectric systems. Both of these systems are designed to operate on a minimum head of 20 feet and 100 gallons of water flow per minute. The "standard" output is 400 watts @ 12 Volts Direct Current or 700 watts @ 24 Volts Direct Current. In their book they site the following as a "typical" installation:

Site Conditions:

Head	100 feet
Flow	15 gallons per minute
Pipe Length	300 feet
Pipe Size	2" PVC
Distance To Battery	30 feet
Output	100 watts

Costs: (from a few years ago)

Pipe	\$100
Turbine	\$875
Regulator	\$340
Batteries	\$180
Wire, etc	\$50
Total Costs	\$1545



Troubled Times



High Head

If you live in a hilly area where there are small streams, you can develop a very adequate power system with very little flow. This is called a **High Head System** and it involves as little as a 50 foot drop with only a one gallon per second flow to yield an average power of a steady 300 watts. This is enough power to drive your lights and other small appliances. With a battery support, or flywheel or spring support, you'll be able to develop a really adequate power system for almost no money and at very little expense. You want to use the **batteries** to store power during the period of little use from 10 PM to 6 AM.

A small dam is set up about 4 feet high and 12 feet wide with logs and rock. At one point there is a **spillway** for the major amount of water, and at another a gate that opens into a canal (race) leading to another much smaller dam and a smaller spill way. From this dam, a penstock (PVC pipe) runs downwards at least 50 feet to the power house. The longer the head run (and the steeper the fall) in the PVC pipe, the faster the water will move through the pipe and the less the actual flow has to be. Steep falls beyond 45 degrees will often require sharp bend in the pipe, and thus reduced head. Also a steep fall will encourage objects to move into the turbine. Sometimes a filtering barrel is put in the top of the penstock to stop trash that could clog the penstock in the middle, requiring dismantling it. In the winter time it needs to be heavily insulated or buried below the frost line.

But in any case, you can vary the output by the diameter of the pipe, the length of the pipe, and the amount of water you can get into the pipe. It relies on a large vertical drop rather than a large volume of water. Thus a power plant near a small stream waterfall, or a contrived water fall. The endpoint generator for this system is called a Pelton Turbine. These operate best with head of 50 feet or more. The high velocity jet of the water speeds the **turbine** runner at high speeds that don't require expensive additional gearing. These runners can be as big as 12 ft. in diameter for million watt installations or down to 18 inches for small home installations. No more water than that which comes from a modest spring will run one. A model that is even smaller and faster than Pelton Turbines is the Turbo Turbine where the incoming water jet is oriented at an angle to the turbine blades.

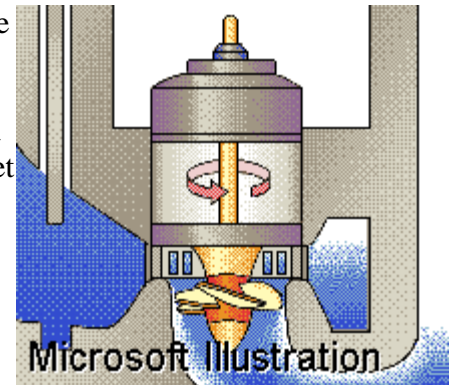

Cost:if you do all the work yourself from lots of native materials, and don't have too many back-up batteries, you might be able to put the whole thing together for 300 watts power for maybe around \$2,000.



Troubled Times



Pump Water

Seeing that we are going to have more water than sun, I came across a non-electric, non-solar water pumping system called the Flemming Hydro-Ram (The Ram Company). It's simplicity at its most elegant!

The Ram Company, Hydro-Ram Prices and Features. - [Fleming Hydro-Ram Prices and Features](#). 1" RAM PUMP Our least expensive standard 1-inch ram requires only 1 gallon per minute water flow. All parts are PVC plastic. Clear air compression chamber allows view of water-to-air ratio.. Order No. RP10000.

Offered by [Pat](#).

There was a lot of information on this in the *Shuttlesworth Mother Earth News* magazines in the early 70's, and some others now. You can actually build your own ram from plumbing parts if you know how.

Offered by [Eric](#).



Troubled Times



Standing Water

We should have an understanding for selecting a [Hydraulic Ram Pumps](#) Why would we be interested in this? They are a class of water pumps that use the inertia of water to pump water to say 10 times the height that water falls. No power source needed. For example let us say we capture a water head pressure of 140 ft into an automatic running Hydraulic ram pump. This might pump 1/12 the volume that enters the pump up the side of a hill to about 1400 ft to a holding tank above where your site is. This would run 24 hrs/day for free. Any excess water you don't use can be converted to electricity. With prevalent rain after the pole shift one could divert water to your holding tank from further up the hill. Once the rains stop or slow down, implement the Hydraulic Ram Pump. The process can be implemented at relatively low cost. The items don't take up much space. They are simple construction and easy to repair, but do take some before pole shift planning and stock piling.

Offered by [Mike](#).



Troubled Times



Aquagen

Hydro power is more stable and easier to set up than wind. All one needs is a induction motor run pump. Run it in reverse with enough pipe to run up stream to get sufficient head pressure. A proper size AC capacitor to tune it for AC generating. A battery to zap it to get it started. Even fast moving streams can be harnessed, as the [Amazon Aquacharge](#) shows. Water flow speeds of 0.45m/s (1mph or 0.87knots)and 1.5m/s. The Aquagens site explains that the Aqua4gen starts to generate at 2.5 knots, and the Aqua6gen starts to generate at 3.5 knots. Looking at these products gives one the Idea one could use a car auto fan (or any heavy duty fan) attached to a pipe or broom stick that went up out of water to a slow speed PM generator or possibly to a belt that drives a car alternator. Car alternators will need to run faster than about 2000 RPM to work. This would all be built on a floating platform anchored to keep it in one spot.

Offered by [Mike](#).

Would this method be a replacement for the towing action described in the Aquagens site? So if it was built in the way you describe, would the effect be the same as people zipping around their sites, towing this turbine as they went? If this is the case, and it has a real chance of working.

Offered by [Helena](#).

Yes, the first link shows a picture of how one might mount it on a stationary raft or boat. The second link show how a set of ropes can be used to hold the generator and how a flex shaft to the propeller can be made of what looks like a rope. I think the concept is sound. Whether it can be implemented by another when needed will depend on the skill level and what can be found at hand. Yes, a car alternator can go faster than 2000 RPM, up to about 5,000 to 6,000 RPM for full charging speed. 2,000 RPM is near the minimum speed. Just some possible design thoughts. Find a source of outboard motor parts new or used. Use without the engine the lower part that clamps to the boat and has a speed reduction gear box with propeller. Do not use a worm gear type. Find a good low speed PM motor to use as a generator. Attach the generator to the vertical shaft that would have been connected to the gasoline engine. Clamp the unit to an anchored floating raft so the propeller is facing the water flow and the generator is above the water. Carrying this thought a bit more. Using an electric outboard motor, one could test turning the propeller by putting it in a fast moving stream (or turn it with a heavy duty electric drill) and see what it takes to generate electrical power. If the unit uses a permanent magnet motor I will bet it will take no modification.

Offered by [Mike](#).



Troubled Times



Purchased

In the latest issue of *Home Power* magazine, I found three adds specifically addressing hydro electric power, though almost all renewable energy dealers can probably sell you something.

Harris Hydroelectric

632 Swanton Rd.
Davenport Ca 95017
408-425-7652

Power Pod Corporation

888-786-3374

Energy Systems & Design

P.O. Box 1557
Sussex, NB, Canada EOE 1PO
506-433-3151
506-433-6151 fax

Offered by [Steve](#).



Troubled Times



Ram Pump

My father is very good with building things. He wants to build a Hydro ram or water ram but nowhere can he find any dimensions. Popular mechanics in the 70's gave how to build your own but most of the materials needed for that aren't available in the 90's. I have been searching the internet and cannot find anything but places to buy this pump. Its funny, you can find sites on how to build a bomb but not a water pump. I guess really not that funny. I would appreciate any help you could give me.

Tammy

I used the Yahoo! Search Engine for information on "hydraulic ram pump" and here is a sample of the search results. You may use any of your favorite search engine for this.

Offered by [Pat](#).

[Home-Made](#) Hydraulic Ram Pump

... Home-made Hydraulic Ram Pump. This information is provided purely as a service to those wanting to try building their own ram pump. Data from our experiences ...

Use a Hydraulic Ram Pump to [Continuously](#) Pump Water

Hydraulic Ram Pump. Low maintenance pumping of water without electricity!
Hydraulic ram ...

[Howstuffworks](#) "How does a hydraulic ram pump work?"

Hydraulic [Ram Pump](#)

A hydraulic ram or impulse pump is a device which uses the energy of falling ...

[Bamford Pumps](#) - Hi-Ram - A New Hydraulic Ram Water Pump

.... is very relevant in a world where energy conservation is increasingly important. The hydraulic ram pump, invented more than 200 years ago, is one such pump. ...

[RH Industries](#) - Makers of the RHI Aqua-Ram Pump

... Although not a modern day or computerized technology, the Hydraulic ram pump is a time tested success. Its energy efficient use of large amounts of water ...

Ram Pump (from Internet [Glossary of Pumps](#))

... *Hydraulic Ram Pumps - How and Where They Work* (ISBN 0-9631526-2-9). It describes how to design, build, and install a simple, efficient hydraulic ram pump. ...

[All About](#) Hydraulic Ram Pumps

... The hydraulic ram pump is a reliable, old-time water pump that works just as well today as ever. Often called a water ram or rampump, one of these simple ...

There were a total of 54 sites that I found on the subject of how to build a hydro ram. Some of them seem to be written in easy to understand terms.

Offered by [Lou](#).



Troubled Times



Back-to-Basics

The easiest way to learn something is to pick up a copy of *Readers Digest's* big back to basics book. It also has lots of other good stuff like an Amish wind wheel which drives a pump directly. If you have a large water stream you can divert it into a big water wheel with a small pond above the water wheel. The hub shaft on the slow wheel drives a big gear which drives a small gear really fast, and it has lots of torque to do it. The other way is to build a small channel to diver the water down through a 4 to 6 inch pipe into a device that has a small wheel in something called a Pelton wheel. This drives the generator.

If you put this stuff in now before whatever the future changes, and the government still exists, you will probably have to deal with enormous amounts of bureaucratic red tape. I once read a very funny series of letters between a state environmental agency and a fellow who had a dam on his property put there by beavers that he was required to destroy and the beavers kept rebuilding it, and the EPA of that state couldn't seem to get the point.

Offered by [Glenna](#).



Troubled Times



Boosted

I came across a site where water turbines are sold. I was wondering - for all you electricians in the group - if a steady 2 Amp output could be used to power something, like for instance a board full of LEDs? Would it be somehow possible to crank up the power output? I am not technical, as some others, so perhaps not using the electrician's jargon would help.

Offered by [Michel](#).

Depends on what you mean by power output. Electrical power (watts) is a product of voltage and ampere ($\text{Watts} = \text{volts} \times \text{ampere}$) so by decreasing one you can increase the other. The simplest way of doing this would be with a few resistors in series or parallel (series divides voltage, parallel divides amperage). You would of course loose a little power in the conversion. For instance 3 equally sized resistors in series with 12V 2A going into the circuit, you take out 4 volts at 2A over each resistor connect this in parallel and presto you have 6A at 4 volts. My recommendation would be to start stock-piling DC motors, motor mounts and water wheels to connect them to, then use a group of resistors in parallel/series (depending what your amp/volt needs are). Used DC motors are fairly cheap (12/24 volt type would be preferable) from scrap-yards and as surplus (search the web, easy to find).

Offered by [Thomas](#).



Troubled Times



Coal Gasification

Article by E. L. Clark.

Coal gasification is a process for converting coal partially or completely to combustible gases. After purification, these gases - carbon monoxide, carbon dioxide, hydrogen, methane, and nitrogen - can be used as fuels or as raw materials for chemical or fertilizer manufacture. From the early 19th century until the 1940s almost all fuel gas distributed for residential or commercial use in the United States was produced by the gasification of coal or coke. In the 1940s the growing availability of low-cost natural gas led to its substitution for gases derived from coal. Interest in coal gasification has been renewed, however, with recent predictions that natural gas reserves in the United States will begin to diminish by 1980. At present, except for by-product gas from the manufacture of coke, no coal gasification plants of any appreciable output are in operation in the United States. Many plants, however, are in operation in other countries that have no reserves of natural gas or petroleum.

Coal may be gasified in a number of ways. The simplest method, and the first used, was to heat coal in a retort in the absence of air, partially converting coal to gas with a residue of coke; the Scottish engineer William Murdock used this technique in pioneering the commercial gasification of coal in 1792.

Murdock licensed his process to the Gas Light and Coke Company in 1813, and in 1816 the Baltimore Gas Company, the first coal gasification company in the United States, was established. The process of heating coal to produce coke and gas is still used in the metallurgical industry.

The most complete conversion of coal or coke to gas that is feasible was achieved by reacting coal continuously in a vertical retort with air and steam. The gas obtained in this manner, called producer gas, has a relatively low thermal content per unit volume of gas (100-150 Btu/cu ft). The development of a cyclic steam-air process in 1873 made possible the production of a gas of higher thermal content (300-350 Btu/cu ft), composed chiefly of carbon monoxide and hydrogen, and known as water gas. By adding oil to the reactor, the thermal content of gas was increased to 500-550 Btu/cu ft; this became the standard for gas distributed to residences and industry. Since 1940, processes have been developed to produce continuously a gas equivalent to water gas; this involves the use of steam and essentially pure oxygen as a reactant. A more recently developed process reacts coal with pure oxygen and steam at an elevated pressure of 3.09 Newtons per sq m (450 psi) to produce a gas that may be converted to synthetic natural gas.

The most common modern process uses lump coal in a vertical retort. The coal is fed at the top with air, and steam is introduced at the bottom. The gas, air, and steam rising up the retort heat the coal in its downward flow and react with the coal to convert it to gas. Ash is removed at the bottom of the retort. Using air and steam as reacting gases results in a producer gas; using oxygen and steam results in a water gas. Increasing operating pressure increases the productivity.

Two other processes currently in commercial use react finely powdered coal with steam and oxygen. One of these, the Winkler process, uses a fluidized bed in which the powdered coal is agitated with the reactant gases. The other, called the Koppers-Totzek process, operates at a much higher temperature, and the powdered coal is reacted while it is entrained in the gases passing through the reactor. The ash is removed as a molten slag at the bottom of the reactor. Both of these processes are being used for fuel gas production and in the generation of gases for chemical and fertilizer production.

As petroleum and natural gas supplies decrease, the desirability of producing gas from coal will increase. It is also anticipated that costs of natural gas will increase, allowing coal gasification to compete as an economically viable process. Research in progress on a laboratory and pilot-plant scale should lead to the invention of new process technology by the end of the century, thus accelerating the industrial use of coal gasification.

Bibliography: Howard-Smith, I., and Werner, G. J., Coal Conversion Technology (1976); Massey, Lester G., ed., Coal Gasification (1974); Schora, Frank C., ed., Fuel Gasification (1967); Schora, Frank C., et al., Fuel Gases from Coal (1976).



Troubled Times



Producer Gas

Now I do not know if during the second world war if cars in the USA were converted to run on Producer Gas, but certainly cars in Australia were converted to run from coal and dry wood and I have seen photographs of these converted cars with the burner on the back. I suspect the USA did not suffer from lack of petrol during the two world wars, so it may never have been done there, but at that time Australia was not self sufficient in petrol as it is now and these Producer Gas cars were common enough and apparently worked well and went everywhere.

Producer gas is a gaseous fuel having a rather low calorific value. It is produced by blowing air over hot coal or coke. If the temperature during the production process is kept high enough, the favored reaction is $2C + \text{dioxygen yields } 2CO$. Because this is an exothermic reaction (one in which heat is given off), the necessary high temperature can be readily maintained. The gas produced is about 35% carbon monoxide and 65% nitrogen. Because the calorific value is low (1,000-1,400 Kcal/cu m; 120-160 Btu/cu ft), transportation costs are an important factor. As a result, its main use is as an industrial fuel produced close to where it is needed.

John T. McMullan

Report by [Darryl](#).



Troubled Times



Home Power

[Home Power](#) has their collection of magazines available in Acrobat format on CD-ROM for \$29.00. Covers alternative sources of home energy, wind, hydroelectric, solar etc. The current issue is available for download in Acrobat format for free. It is 5.9 MB in size so it will take a while to download on a modem.

Offered by [Vince](#).

Home Power magazine is a truly grass roots *and* savvy organization. They have an excellent 5 page article for free download, on a well tested 12V DC Engine/Generator for recharging emergency batteries, which you can build-complete with 3 illustrations in color, wiring diagrams, and sources for parts.

Offered by [Phil](#).



Troubled Times



Basics

For Energy Production you need three things:

Power Source:

- solar voltaic modules
- windmills
- hydropower mills
- diesel/gas/propane generators

Energy Storage:

- Batteries- 12 volts or 24 volts
- Charge control module-prevents overcharge of the batteries
- Fuses & Circuit Breakers

Energy Conditioning:

- Battery Charger
- Inverter-changes battery power to 120 volts AC to run appliances
- Transfer Relay switches power from diferent sources

Offered by [Glenna](#).



Troubled Times



Thermo-Electric

I found a company that has thermoelectric generators for sale from an article from the latest [January, 1999] issue of *Popular Science*. The email they sent me is below for details.

Offered by [Steve](#).

Dear Mr. Ferguson:

Hi-Z is presently selling only the thermoelectric generating modules (**HZ-14** and **HZ-20**) shown on our Internet website. We are not really in the generator business. We do plan to offer a woodstove stack generator in 1999, but it is presently not ready for market. Most of the other generating units shown on our website are applications by others or generators that we have built on development contracts for others.

Our prices FOB San Diego, plus shipping:

HZ-14

1 -9 \$ 195 each
10-99 \$ 175 each
100-499 \$ 149 each
over 500 can be quoted

HZ-20

1 -9 \$ 235 each
10-99 \$ 210 each
100-499 \$ 180 each
over 500 can be quoted

I am told we may be reducing these prices soon, but this is our current pricing.

In most applications you must use insulating wafers on both sides of the module. We recommend the use of heat transfer paste with these wafers. (Refer to the information on our Internet website concerning the use and application of the modules:"www.hi-z.com/how-to.htm") Hi-Z can provide these materials also:

HZ-14 ceramic wafers (two needed) \$ 3 each
HZ-20 ceramic wafers (two needed) \$ 5 each
2 oz. heat transfer paste \$15

We prefer to ship by USPS Express Mail for smaller orders, but shipment can be requested by FedEx, UPS or standard mail. Please be sure to specify shipment method.

Sales tax of 7.75% is added to shipments within the state of California, unless the purchaser is a government agency or unless the order is indicated for resale and a California resale number is provided to us with the order.

We accept Purchase Orders by mail or FAX (619 695-8870) from recognized US and Canadian businesses and government agencies. For sales to individuals we ask for payment in advance, and at this time we do not take credit cards.

Yours sincerely,

Hi-Z Technology, Inc.

7606 Miramar Road

San Diego CA 92126-4202

tel.: 619 695-6660

FAX: 619 695-8870



Troubled Times



Nuclear Plant

Where to go to get a small nuclear power plant.

Offered by [Mike](#).

Dear Mike,

Thank you for your enquiry regarding small nuclear power plants.

There has been much interest of late in the use of small reactors to provide electricity to local communities. As yet, there are no commercially available power plants with capacities as low as 10MWe. The first generation of nuclear plants had small capacities (up to about 40 MWe), but the trend since these were built has been to make reactors bigger and bigger. Although there are many small research reactors, they are not configured for the production of electricity - they are purely for examining the fission process. There are however, several projects involved in the development of small reactors for power generation. You may find the following paper presented at the 23rd UI Symposium (1998) of interest: "*The role of small and medium-sized reactors*" by Jurgen Kupitz and Victor M. Mourogov. You may like to contact Mr Kupitz, who is Head of Nuclear Power at the **International Atomic Energy Agency** (IAEA). His contact details are:

Room A2570, PO Box 100
Austria
Tel: +43 1 2600 22814
Fax: +43 1 2600 29598

One particular company, **Eskom** of South Africa, has introduced a **Pebble Bed Modular Reactor** (PBMR) with a capacity of 100 MWe. They aim to sell the plants throughout Africa and other developing regions. You may wish to discuss your interest with them. Their contact details are:

[Eskom](#)
PO Box 1091
Johannesburg 2000
South Africa
Tel: +27 11 800 8111
Fax: +27 11 800 5771

There is 10 MWe demonstration modular pebble bed reactor under construction at the **Institute of Nuclear Energy Technology** (INET) of **Tsinghua University**, China.

Hope this information is of use to you.

Yours sincerely,

[Warwick S.A. Pipe](#)
Information Officer

[Uranium Institute](#)

12th Floor, Bowater House West,
114 Knightsbridge
London SW1X 7LJ
UK

Tel: (44) 171 225 0303

Fax: (44) 171 225 0308



Troubled Times



Flywheel

My understanding of flywheels is this: It is basically a capacitor that works by having its rotor spun via electrical or mechanical power. That spinning rotor essentially stores the electrical energy as mechanical energy. **Trinity Flywheel** already has a product. They describe their product as a mechanism for smooth transmission of energy, but what I'm talking about is more along the lines of storage. Now that I've researched it more, it seems a little less practical for long term storage I'm sorry to say. I was thinking that windpower could possibly store its energy in flywheels for long term storage, when, and if the winds die down. This would avoid the chemical breakdown that occurs in rechargeable batteries where any breakdown in the flywheels could be fixed mechanically thus used for a much longer period of time. (Incidentally, however, flywheels can be constructed so that they float on a cushion of magnetic energy, hence no friction, and less "wear and tear".) This stored energy would be used as a contingency, as I've said, with another windpower device, or possibly a portion of routed current, to be used to grow the food in the food production tents. I have some engineer friends that I will email who may be able to give me some more information on the feasibility of a long term storage device. I have the feeling that it would probably be too expensive and very massive, but, who knows?

Offered by [Ted](#).

Concerning using flywheels as storage vs. batteries. Some of the concepts are still "speculative" but one company does have something for sale today. The Beacon Flywheel weighs 150 lbs., rotates at 20,000 rpm and sits inside a big cylinder that resembles a squat 55 gallon oil drum with a rounded top and bottom and you can buy one right now for about \$15,000. "It should last 20 years" says Saliba "and you shouldn't have to service it for six or seven. We just put a foot or two of dirt on top of it, switch it on and walk away." They also expect the price to drop by a factor of 4 (to approximately \$4,000) within 2 years as production gears up. I believe the article said it supplies a kilowatt of power for 2 hours.

Offered by [John](#).

This result is at the best about \$2,000/Kilowatt-hr for 20 years. If batteries were used and it's cost is between \$100-200/kilowatt-hr, then we are talking the cost of a battery change every year or two. Batteries should typically last longer than this. Also, if these things are spinning when the pole shift happens, I believe they could be damaged with the sharp jolts. I think for the foreseeable future stock piling batteries to be more cost effective. There may even be better ways to store electrical energy. It should be noted that this technology is getting close to being cost effective and it bears keeping an eye on.

Offered by [Mike](#).



Troubled Times



Waste Water

Dirty Bath Water Could Fuel Industry

By Charles Arthur, *Technology* Editor

A hot bath can do more than inspire deep thought, according to a British scientist who has used one to power a television set. Mike Rowe, of Cardiff University, has built a system that can generate 100 watts using the temperature difference between his cold water supply and a bath full of used hot water. Professor Rowe says his system can be applied on an industrial scale to provide large amounts of electricity at low cost. "This is part of a seven-year contract from the Japanese government, seeking ways to recover waste heat that presently goes down the drain - literally - from industry," Professor Rowe said yesterday. "All that this system needs to work is a temperature difference: a hot bath is about 55C, and the cold water supply about 50 degrees cooler. From that, we can generate 100 watts in our lab setup - and a colour TV needs only 80 watts."

The system uses a series of thermocouples, which produce power because the difference in temperature between two points will generate a voltage difference if the correct materials are chosen and placed at the respective points. Typical thermocouples use metals, but Professor Rowe has found that usable voltages are can also be generated by semiconductors such as germanium and silicon. The industrial applications are potentially huge, and could save millions of pounds by using hot water discharged from the steel, glass, ceramics and electricity generating industries. The steel industry, in particular, produces waste water with a temperature of 90C - too low to power a steam turbine, which requires 140C - so the water is often simply thrown away.

Water is an ideal material for thermocouple systems because it can absorb large amounts of energy. "The great thing is that in essence the energy source - the hot water - is effectively free. We have devised a system that can generate 2 watts for only \$5 [£3.12]." Professor Rowe's system could also benefit the environment if it is taken up by industries that currently discharge waste into rivers: high outflow temperatures have been blamed for affecting the life cycles of river animals and fish.



Troubled Times



Geothermal

If one has hot ground (water flowing or not, doesn't matter) near where one lives then a distillation tent can be set up. This could use the cooler air (could be water though) around it to condense the water on the inside of the tent. A water holding container would be constructed over the floor of the tent. Water evaporates from the hotter floor and condenses on the inside of the tent to run into collection troughs and then containers. The temperature doesn't even have to get up to boiling, just say 10 to 20 degrees Fahrenheit hotter than sounding air could be enough to use the distillation process. The hotter the faster the distillation process.

This is very simple in its construction. One needs PVC-Pipe, PVC- fittings, and plastic tarps; a flex tube and container to collect the distilled water; a little silicon rubber to make the seal where the hose goes through the plastic; a funnel to fill it; adjacent sources of heat and coolness. The greater the difference in temperature, the faster water can be distilled. The limited life of plastic tarps could be a disadvantage. Clear thick vinyl might be the longest lasting. Any plastic may leach out some toxins (plasticides) into the distilled water. This would become less with usage, and this may be a better alternative than lead poisoning. Still in its infancy, this idea can be developed within the next two years, if you think that your group will have access to post-pole shift geothermal energy.

Offered by [Mike](#).

STILL-TENT DISTILLATION PRINCIPALS

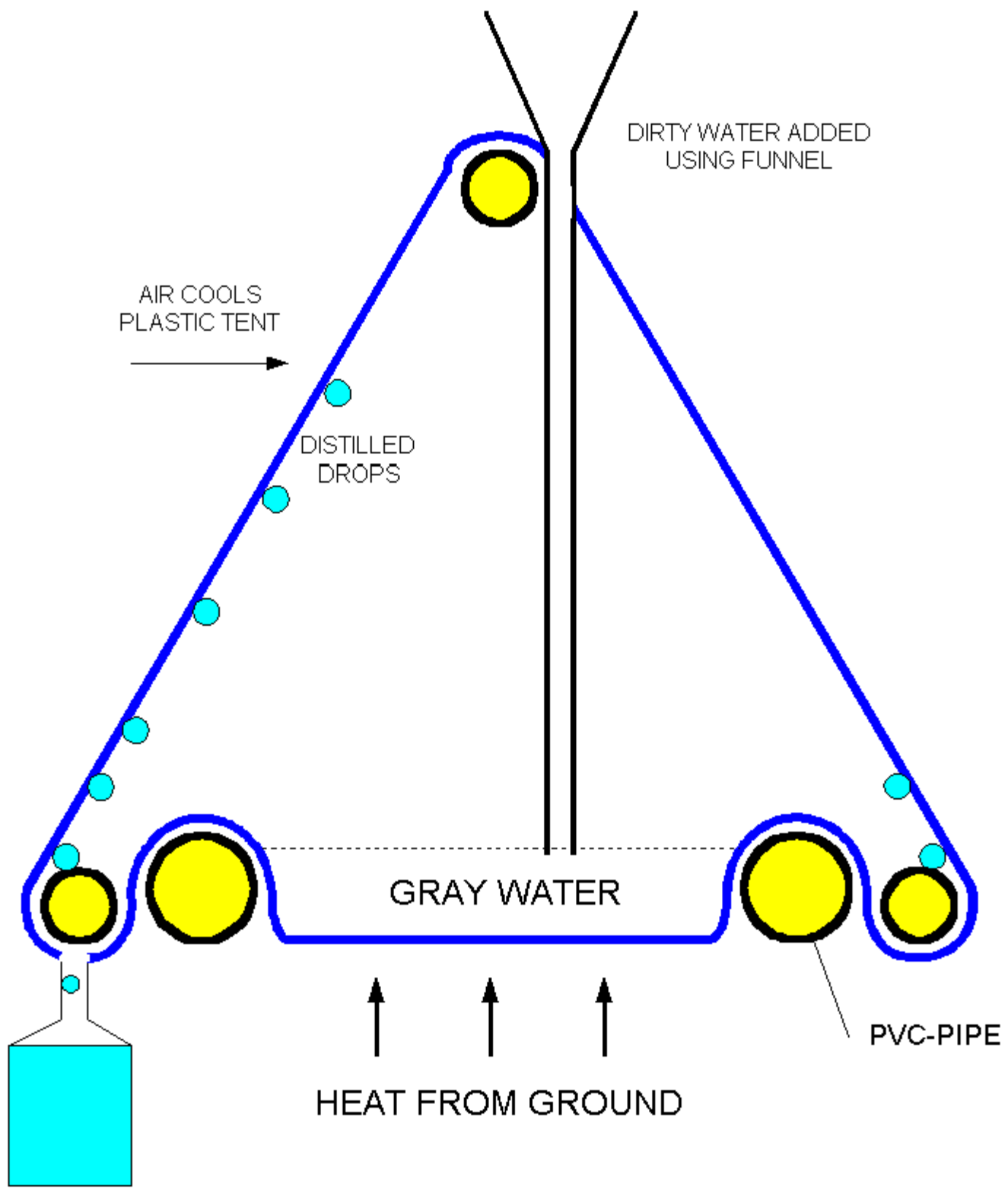

Troubled Times



Fuel Cells

Fuel cells seems to be ready for production this year, and should be available next year, so this seems to be a better candidate. Can integrate well with the other electrically based sources of energy.

Offered by [Wayne](#).

Looking at the cost/Kwatt-hr of the greenvolt. PM-135 produces about

$$13.5 \text{ volts} * 10 \text{ amps} * 50 \text{ hrs} = 6.75 \text{ Kwatt-hr}$$

of electricity. Plates are then worn out. Cost of new plates is \$45. This gives a net result of

$$\$45 / 6.75 \text{ kwatt-hr} = \$6.66 / \text{kwatt-hr}.$$

Now using a rough order of magnitude calculation. If one purchases a 1Kwatt wind or hydro unit for say \$2000 and it produces an average of .5 kwatt/hr for 10 to 20 years. Then approximately

$$2000 / (.5 \text{ kwatt} * 10 \text{ years} * 365 \text{ days} * 24 \text{ hrs/day}) = \$.023 / \text{Kwatt-hr}.$$

It's approximately $6.66 / .023 = 290$ times more costly to use this fuel cell over a windmill or hydro-generator. I think this has some emergency uses, but for a continuous power source, unless the price comes way down I doubt it will be practical for a PS now 2 years away. Am I missing something?

Offered by [Mike](#).

You're looking at the wrong product. That is their emergency fuel cell product. They are now focusing on their alkaline fuel cell that will be in production at the end of this year. They will have a 1.3 kw product, followed by a 5 kw product that can be modularly connected to up to 350 kw. Their market focus is on stationary, portable, and vehicle applications. If you check their technical section, there is more info on this. Their development section shows a test program of driving a highway vehicle for 3,000 to 4,000 miles on one charge later this year!

Offered by [Wayne](#).

From the data presented I don't see any reason to get excited about this Alkaline fuel cell. I expect it will need a continuous supply of hydrogen, oxygen, Anodes, Cathodes, and KOH at some yet determined cost. The over all cost/Kwatt-hr figuring in the cost of the consumables needs to be determined once this data is known. Can you keep track of this and let us know what the cost of operation analysis is once this becomes a sellable product? I don't see enough data in this site at this time to determine it. Don't get me wrong. I am hoping for a cost effective break through, just like all the rest of us. But we need to have a very practical look at it and not be taken in by the over selling of benefits as compared to true cost - typical marketing tactics.

Offered by [Mike](#).



Troubled Times



Portable Generators

Contact: Staci Maloof (staci.maloof@pnl.gov)

509-372-6313, *Pacific Northwest [National Laboratory](#)*

Small fuel processor powers light-weight soldiers' system

When 21st century soldiers suit up for the battlefield in helmets featuring image displays and laser range finders, one of their most important accessories may be a new power generator so lightweight a soldier can carry it with him. The "man-portable generator" is being developed at the Department of Energy's Pacific Northwest National Laboratory for the U.S. Army's Communications-Electronics Command. The Army faces an increased demand for power as it pursues futuristic cyber systems for soldiers, such as heads-up displays and global-positioning systems. The man-portable generator would supply the power needed for these advanced technologies by generating 15 to 25 watts of power inside a system weighing 10 times less than batteries soldiers currently carry. The increased power density would allow soldiers to either reduce their load or greatly extend their missions.

In March, PNNL engineers reached the first major milestone in development when they demonstrated a full-size, advanced design fuel processor that converts methanol into hydrogen. Because hydrogen wouldn't need to be stored or carried, the fuel processor would reduce the weight and risk associated with portable power systems. "We've taken a significant step toward light-weight power generation with this breadboard-stage fuel processor," said Ed Baker, PNNL project manager, referring to the development stage between creating a proof-of-concept and a prototype system. "Our system produces the hydrogen that fuel cells need to create power. We expect to create hydrogen from liquid fuels such as methanol, synthetic diesel and possibly military jet fuels. Each of these is more readily available and easier to carry than hydrogen."

Based on the encouraging results of the breadboard-stage development, PNNL engineers are designing a prototype fuel processor and hope to have it tested within the next year. Then, they will face the challenge of integrating it with other components of a complete power system, including a micro-scale fuel cell, a fuel storage and a delivery unit, and a battery for peak power. They hope to have the complete power system ready for testing by 2003. "By then, we expect infantry soldiers to use a variety of electronic gear, such as heads-up displays, global positioning systems, laser range finders and thermal weapons sights," said James Stephens, team leader for fuel cell technology with the Army. "Integrated computer and communications devices will allow the soldier to be aware of their location, as well as that of fellow soldiers. The net result will be a significant improvement in their capabilities. "It all takes power, but we can't ask these soldiers to carry any more weight." Weight would be reduced dramatically - the man-portable generator would weigh as little as two pounds. The best lithium batteries currently available would have to weigh as much as 20 pounds to provide equivalent power for one week. And, the generator's fuel processor allows the system to be refueled so it can be used again. In addition to the reduction in weight, engineers at the Army and the laboratory expect the portable generator to be less expensive than batteries.

PNNL engineers based the fuel processor design on 1- to 10-kilowatt prototypes they have built for use in automobile power systems. The processor being developed for the man-portable generator consists of four micro-technologies: a combustor, vaporizer, primary conversion reactor and a gas cleanup device. It uses

a proprietary catalyst to produce hydrogen from hydrocarbon fuels. Reactions take place within small channels of a catalytic converter. These micro-channels enhance heat and mass transfer rates and significantly speed up chemical reactions, which reduces the device's size. The laboratory's microtechnology group is well recognized for its efforts to miniaturize chemical and thermal systems, and it won two R&D 100 awards in 1999. "Our scientists are pioneers in the microtechnology field," said Terry Doherty, who manages the laboratory's Army-funded research. "The man-portable generator is a natural next step as we apply this expertise to portable power issues."

Business inquiries on this or other PNNL technologies should be directed to 1-888-375-PNNL or e-mail: inquiry@pnl.gov. More information on the laboratory's microtechnology research is available at <http://www.pnl.gov/microcats/>

Pacific Northwest National Laboratory is a DOE research facility and delivers breakthrough science and technology in the areas of environment, energy, health, fundamental sciences and national security. Battelle, based in Columbus, Ohio, has operated the laboratory for DOE since 1965.



Troubled Times



Algae Hydrogen

Enzyme Lets Algae [Produce Hydrogen](#) To Use As Clean Fuel

Chronicle, Jan 31, 2000

Berkeley scientist says discovery is like 'striking oil'

Researchers have found a metabolic switch in algae that allows the primitive plants to produce hydrogen gas - a discovery that could ultimately result in a vast source of cheap, pollution-free fuel. Hydrogen, which can be used as a clean-burning fuel in cars and power plants, is virtually limitless in availability, because it is part of the water molecule. It is a candidate to become the world's primary fuel in coming decades. But until now, it was obtainable in quantity only through relatively expensive extraction procedures involving the electrolysis of water or processing natural gas.

The breakthrough, by scientists at the University of California at Berkeley and the U.S. Department of Energy, would make possible the commercial production of hydrogen gas by photosynthesis in tanks, ponds or the open ocean. "I guess it's the equivalent of striking oil," said Tasios Melis, a microbial biology professor at UC Berkeley. "It was enormously exciting. It was unbelievable." Melis made the discovery with UC Berkeley researcher Liping Zhang and with Michael Seibert, Maria Ghiardi and Marc Forestier of the National Renewable Energy Laboratory, a Department of Energy project in Golden, Colo. The team's findings appear in this month's issue of *Plant Physiology*, a science journal.

Seibert said it has been known for decades that algae give off small amounts of hydrogen. The problem from a commercial perspective, he said, was hydrogenase - an enzyme that produces hydrogen, but does so only in the absence of oxygen. All green photosynthetic plants - including algae - consume carbon dioxide in the presence of light to build tissue, respiring oxygen as a waste product. "But because hydrogenase shuts down in the presence of oxygen, it doesn't function during photosynthesis," he said. "It basically only works during darkness, when photosynthesis isn't occurring."

Because plant functions are at low ebb during darkness, Seibert said, the amount of hydrogen produced is minimal. But the team was able to solve the problem, said Seibert, by imposing a "nutrient stress" to the algae. "First we grow out the algae, 'fatten' it under normal photosynthetic conditions," he said. "Then we withhold sulfur." Sulfur is critical for the completion of normal photosynthesis, Seibert said. In the absence of the element, the algae ceased emitting oxygen and stopped storing energy as carbohydrates, protein and fats. Instead, the algal cells began using "an alternative metabolic pathway" to exploit stored energy reserves anaerobically - in the absence of oxygen. The hydrogenase was activated, splitting large amounts of hydrogen gas from water and releasing it as a byproduct.

"The significant thing is that the plant is using the energy of the sunlight to produce hydrogen, not oxygen," said Melis. "Without sulfur, it produces a great deal more hydrogen in the presence of light than it does under normal circumstances in the dark." The algae ultimately would die if the nutrient stress were maintained for more than a few days, but they can be "fattened" again with sulfur and sunlight, allowing for repetitions of the process and continued harvesting of hydrogen gas. Eventually, the process could be used for the production of huge quantities of hydrogen. Hydrogen burns clean and hot, and it constitutes one-third of the water found in the Earth's oceans, rivers, lakes and atmosphere.

Cars already have been developed that run on hydrogen-powered devices known as fuel cells. These vehicles are virtually pollution-free; the only substance emitted from the tailpipe is water vapor. They do not release carbon dioxide or other heat-trapping gases, which are widely considered the primary culprits in global warming. Fuel cells big enough to power electrical generating plants could also be built. “Our long-term goal is to develop strains of algae that we would grow in mass cultures to produce enormous quantities of hydrogen gas,” said Melis. “But at this point, we have to improve the production performance.”



Troubled Times



Hydrogen

I am working on a new project and would like to know if anyone else is working on this as well. The project is the development of a method to produce (post-pole shift) a fuel as concentrated in energy and convenient to use as gasoline (petrol). My previous research has led me to alcohol and hydrogen peroxide. For a number of reasons I've chosen to go the hydrogen peroxide route. Has anyone else out there done anything with this idea?

Offered by [Ray](#).

Just curious but how would one make hydrogen peroxide after the pole shift or in a primitive environment?

Offered by [Mike](#).

There are a few processes available the one I'm investigating is the electrolytic process. By using wind or hydro electricity I hope to convert water into H₂O₂. While time consuming it does provide a way to create a concentrated fuel without big business or access to complex chemicals. I can not detail an exact method because I'm still developing it. Basically it is a simplification and miniaturization of commercial electrolytic techniques. When I'm further along I'll be glad to share the techniques I develop. There are still a few bugs in the system that make it unsafe.

Offered by [Ray](#).

Have you ever heard of energy being produced from separating the atoms of hydrogen? The "machine" is a plastic case about 10" by 12" about 2" thick. It separates the atoms and produces only steam as a waste. This is in production now and is being considered for use in some California cities.

Offered by [Regina](#).

Regardless of how you build the machine, it requires hydrogen as fuel. I see two problems with this:

1. Where do we get the hydrogen? Of course you can use 'electrolysis' to break down water into hydrogen gas and oxygen gas, and this is easily collected. However, electrolysis requires electrical energy. So we'd need electric power to get hydrogen power--not a solution to power needs. (However, if electric power can be generated by wind/water/otherwise, hydrogen might be used for gas stoves, heating, and ultimately propulsion.)
2. Storing [Hydrogen](#) is dangerous (as the Hindenberg attests)! The same can be said for methane.

Offered by [Gabe](#).



Troubled Times



Robots

A report brought by the [CNN website](#) says that a robot running on meat has been produced. No Joke.

Offered by [Michel](#).



Troubled Times



Electric Eels

My mind thought of electric fish today and that Egyptians kept electric fish and they can be found back on Egyptians tombs. Specifically *Malapterurus electricus*, an electric catfish that sporadically can be found in tropical fishstores. It can produce up to 450 Volts. An electric eel can produce up to 600 Volts. In Artis, a zoo in Amsterdam, I saw a large fishtank with two electric eels in it. There was an indicator in contact with the water showing the currentflow/voltage in the water. The attached light/led was almost on continuously.

Offered by [Michel](#).



Troubled Times



ElectroMagnetic

Information on our Motionless Electromagnetic Generator has now been publicly released, in the form of our paper, *The Motionless Electromagnetic Generator: Extracting Energy from a Permanent Magnet with Energy-Replenishing from the Active Vacuum*, carried on public DoE website. Thus you may furnish the information to whomever you wish, since it is now publicly released and can be freely downloaded. It is a long paper (69 pages) and does take a little time to download. We are encouraging web site managers who so wish, to place a pointer to the paper if they wish to. As you are aware, this one works beautifully and produces COP=3D5.0. Our patent application has been filed and so full patent coverage is retained; we have been in patent-pending status for some time prior to the public release. We expect to force the patent by direct demonstration and independent government-certified test laboratory testing and certification to NIST, IEEE, and U.S. Government test standards.

The system uses an extension to the work-energy theorem: In a replenishing potential environment, when energy is removed from the potential in a different form, the potential is simply replenished by the giant entropy process (my paper on the giant negentropy process is on the same DoE website). Use of a permanent magnet simply uses its magnetostatic scalar potential to evoke and sustain the giant negentropy mechanism. This sustains the continuous flow of the magnetic vector potential, and the device separates the magnetic B-field from the magnetic vector potential A. The giant negentropy mechanism continuously replenishes the A-potential as fast as energy is extracted from it. Thus it is rather like dipping bucket after bucket of water from the same spatial volume in a rushing river, with the river instantly filling the hole up each time a dip is made. In this case we must pay only for the switching costs, since the giant negentropy mechanism continually replenishes the magnetic dipole sustaining the magnetic vector potential energy flow. Note that we do not destroy the source dipole, as every conventional closed current loop electrical system does. As Whittaker showed in 1903, once the dipolarity is established, the giant negentropy process continues so long as the dipole exists. Dipoles in original matter, e.g., have been pouring out copious energy by this process for some 15 billion years, so the energy is absolutely inexhaustible and copious.

There are 23 illustrations in the Magnetic Energy Ltd. paper on the DoE website.



Troubled Times



Magnets

I've been learning and working for a few months on how to make a viable sustainable, over unity energy system. The device known as the **Sweet Vacuum Triode** is something I'm going to attempt to replicate, for those interested a page on his website is here outlining construction details and theory.

There are also theories and designs for unusual propulsion and communication devices. There is some work being done on what is called a **Scalar Wave Transmitter** that bucks magnetic fields together producing a wave of energy "potential" that supposedly can travel faster than light. It has limitations as the coils used have to be precisely aligned, but ham radio operators have had some success with them.

Offered [Ted](#).



Troubled Times



DOE

It's always nice to see your tax dollars paying for useful services. One of the best organized alternative technology internet resources is the [DOE's Energy Efficiency and Renewable Energy Network](#) web site. This site contains links to hundreds of organizations, web sites products, and companies involved in energy efficiency and renewable technology. Are you looking for information on solar, hydrogen, biomass, wind power, or alternative transportation? Do you have a question about a renewable technology that nobody can answer? Then this site may be just what you're looking for.



Troubled Times



History

Experimenting with arc lamps started in the [early 1800's](#).

The ultimate arc lamp is lightning, and so Benjamin Franklin's 1752 experiment of drawing electricity from the clouds and jumping a spark is perhaps the first arc lamp. In 1801 Humphry Davy observed the brilliant spark obtained when the connection between two carbon rods, attached to the poles of a battery, was broken. Some years later, in a demonstration lecture at the Royal Institution, he produced an arc nearly three inches in length. He used a voltaic battery with 2000 sets of plates, each four inches square. Commercial arc lighting had to wait for the development of dynamos such as the Gramme Machine in the early 1870s.

[Experimentation](#) moved to enclosing the arc in an air tight bulb to reduce consumption of the rods and regulating the current passing through the rods.

The earliest type of arc lamp was called the open arc because it was operated with the carbon electrodes exposed to the atmosphere. At the time of its introduction it was the most powerful artificial illuminant known and received much recognition. These earlier lamps had many disadvantages, the principal objections being the unsteadiness of the light and the rapid consumption of the carbons (it was not uncommon to replace the carbons every 8 to 10 burning hours). These lamps operated in series at about 50 volts, the number on a single lighting loop limited by the maximum voltage the central station generator could provide.

An improved type was introduced around the mid-1890s known as the enclosed arc where the electrodes operated within a glass globe. Since this inhibited the amount of air that could enter the arc, this had an immediate benefit of dramatically increasing the electrodes' life (typically 100-125 burning hours). The longer life of the electrodes outweighed the fact that these luminaries were less efficient than the open arc lamps. Both types of arc lamps are also known as "crater arcs". The tip of the positive electrode assumed the shape of a hollow crater and emitted about 90 percent of the light from the lamp, relatively little coming from the arc itself or the negative electrode.

It was found in later studies that certain chemicals could be combined with the carbon to form the electrodes that provided a highly luminous arc. This led to the development of the flame-carbon arc, so called because the arc stream provided most of the light. The efficiency of this type of lamp was three times that of the old open-arc lamp and about ten times that of the enclosed type.

Arc lamps operated best on circuits operated by special generators or transformers that closely regulated the circuit current at a constant value. In practice, most early series arc currents ranged from 4 to 10 amperes, but the most common circuits operated at 5.5, 6.6 or 7.5 amperes (6.6 amperes would later be established as the standard current for series circuits). The arc voltage of the various types of lamps ranged from 50 to 80 volts and since the lamps were connected in series, the voltage of the system depended on the number of lamps - in practice, the circuit would typically be operated at several thousand volts. These lamps were designed for operation on either direct current or alternating current circuits; the

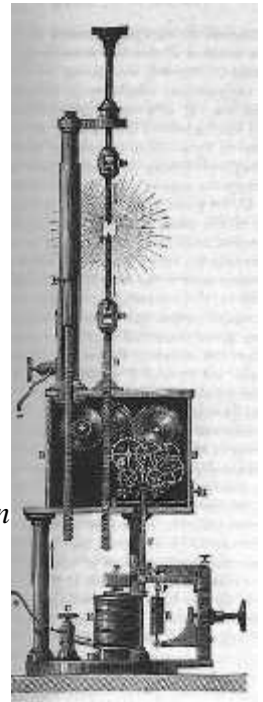

exception was the magnetite arc, which required direct current. In order to operate these magnetite arc lamp circuits, mercury-arc rectifiers were utilized to do the necessary conversion from AC to DC.

In a few rare cases, arc lamps were operated in multiple at secondary distribution voltages. Since the conductivity of the arc is non-linear, it increases greatly with increased current. As the arc heated up, the ionized gases in the arc decreased in resistance allowing still more current to flow. This was a fundamental characteristic of all arc and electric discharge types of light sources. This is not an issue when operated in series as the power source holds the current at a constant value, however on multiple circuits, additional equipment is required to limit the current available and prevent a short-circuit arc. This additional equipment took the form of a resistance when used on DC circuits or a reactance coil when used on AC circuits, and often consumed just as much energy as the arc itself!



Troubled Times



Street Lights

These lamps work best in the direct current that alternative energies such as wind or water mills will furnish, and carbon is a readily available natural substance. **Encyclopedia Britannica** gives the historical background on carbon arc lamps as street lights:

The incandescent lamp was not the first electric lamp; lighting devices employing an electric arc struck between electrodes of carbon had been developed and were in use earlier. Arc lamps were massive and complicated pieces of equipment that could be installed and maintained only by a skilled engineer. Used for street lighting, arc lamps had advantages, including reasonable reliability, high efficiency, and above all, a pleasant color, closely approximating natural sunlight. The light of the arc lamp was particularly kind to the color of the human complexion and the stone of historic buildings. Partly for this reason, these devices were retained in dignified city settings - for example, in the City of London - long after more modern light sources had come into wide use. A device for producing light by maintaining an electric arc across a gap between two conductors; light comes from the heated ends of the conductors (usually carbon rods) as well as from the arc itself. The Yablochkov candle, an arc lamp invented by the Russian engineer Paul Yablochkov, was used for street lighting in Paris and other European cities from 1878.

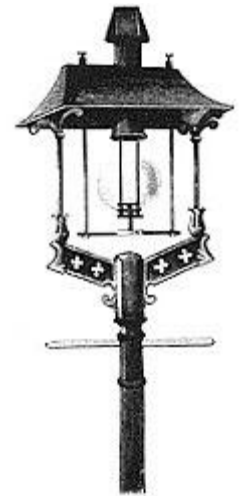

STREET LAMP.
Brush arc-lamp for streetlighting.

Carbon Arc lamps were used to [light the streets](#) of London and Paris, with a light that approached the light of day.

Yes, there were electric lights powered by central stations before Edison's! Carbon arc lamps saw extensive use throughout the USA and the world from the late 1870s on. Due to their intense light they were not that practical for lighting small interior spaces. However even after the advent of the incandescent bulb, arc lamps survived for decades being used as streetlights and for lighting large interior spaces like factories, mills, and department stores. Early incandescent lamps produced about 16 candle power, while arc lamps produced 2,000-4,000 candle power. Incandescents just didn't have the output or efficiency of arcs. Today carbon arcs are still used in some large spotlights and projectors.

How do arc lamps work? Well two carbon rods connected to a current limited source are brought together and then drawn apart. As the carbons separate, a hot ionized path is created between them (the arc) that continues to conduct after the carbons have been separated. This arc burns at thousands of degrees and heats the ends of the carbons to incandescence. Most of the light comes from the tips of the carbons, not the arc itself. As the carbons burn down they need to be constantly adjusted to maintain the proper spacing so that the arc does not go out. Part of what is fascinating about early lamps is the range of ingenious mechanisms that were used to do this. Everything from manually adjusted designs to complex clockwork mechanisms were tried, and as you might guess reliability became a major issue. One design overcame this hurdle and became commercially successful by the late 1870s ushering in the era of electric light.



Troubled Times



Bright

Carbon Arc is full spectrum, equivalent to sunlight, and thus its potential as a grow light for indoor gardens and to prevent Vitamin D deficiency in the gloom of the Aftertime. The **Electric Museum** reports on an old lamp pulled from a junk pile, and lit!

These lamps are each about four feet tall, solid iron, and each weighs a considerable amount. The tube extending out the top Lamps like these could produce between 2,000 and 4,000 candle power. In 1880 Wabash Indiana had used just four Brush lamps of similar design to light the entire town and earn itself the title of first city anywhere to be wholly electrically lit. Remember that this was a time when gas and kerosene lighting were common. Incandescent lamps were just starting to show up in a few cities for indoor lighting, but could only produce about 16 candle power Carbon arc was a proven and established technology, and remained the brightest artificial light source until fairly recently.

The photo on the right shows the first lighting of this arc lamp in probably well over 100 years. The last time this lamp operated was in a world of gas lamps and horse drawn carriages. At the time most people had never seen an electric light before. Just imagine what it would have been like to see a 3,000 candle power arc lamp when all you knew were relatively dim gas and kerosene lamps. In this shot the camera's lens flare exaggerated the arc. Here the lamp is being powered by a very simple current limited DC power supply, and the cover is off the lamp mechanism.



When using Carbon Arc, consider this as sunlight, and [protect the eyes](#) and even the skin if exposed for long periods of time. Wear sunglasses. When Carbon Arc was used routinely for lighting movie scenes, the actors would develop skin cancers and deep tans as though they had been outside in sunlight!



Troubled Times



UV Intensive

My research on the web for carbon arc lights yields several warnings about [high UV](#), output of carbon monoxide, etc. In addition to being hazardous to your health, illegal in some states in fact, carbon arcs use an ungodly amount of power.

Offered by [Ron](#).

Phosphors convert UV into [full spectrum light](#)!

Offered by [Pat](#).

Warning to any and all who use battery cores or *any* form of carbon arc lighting. The arc light produced is rich in UV Light that will *blind you* over time without protection. It is the same type of light produced by an arc welder! I was a projectionist and have worked with the carbon arc motion picture projectors and I am a certified welder and a field engineer with extensive experience with carbon rods of all sizes. If you are using carbon arc lighting without UV shielding *stop at once*. You are blinding yourself. The type of damage done is subtle, progressive and irreversible. If you doubt me please check with your country, state or province's worker safety office or ask any experienced arc welder or anyone who has worked on the old (1930-1960) era movie projectors.

Offered by [Ray](#).

It is my current understanding that certain types of glass and plastic will not pass much if any UV. I guess as a worst case one could probably put a couple of burned out florescent lights in front of the arc. The phosphorus coating on the tubes would convert UV to visible light.

Offered by [Mike](#).

You're right that there are certain types of glass and plastics that will effectively shield you from UV. The first thing to remember is that there are more than one type of UV. The 2 types were mostly concerned with are long wave and short wave. The short wave is the most damaging. Most good sunglasses will protect from small amounts of long and short wave but not from the amounts and frequencies produced by carbon arcs. The only truly safe way to view any carbon arc is through an appropriate filter. The most commonly available filters are arc welder eye shields, lenses and filters, available from any welding supply store, most tool stores and Sears. The best general purpose filter is a #10 (often called a #10 shade), a #5 filter can be used for indirect viewing (no direct view of the arc) but a darker filter would be better. Also remember that carbon rods are hydroscopic (they can absorb water from the air) if the rod has a void and the void becomes filled with anything when the hot arc hits it you can have a mini explosion (the bright pops and sputters you see around a welder) this is why the pros always wear the leather gear and full face shielding helmets. If you absolutely must use carbon arcs for lighting, reflect the light off of a rear silvered mirror onto a pale or white background. This will help scatter and diffuse the harmful UV and Infrared to levels briefly tolerable to human eyes. Limit the use of the light to less than five minutes.

Offered by [Ray](#).



Troubled Times



Mechanism

The Carbon Arc rods are in contact with each other at the start, only pulled apart to create a gap when electric current has started to flow. This gap is what creates the arc, and thus, the light. Here is a [Description](#) on a dual lamp mechanism where the gap is controlled by a solenoid, automatically adjusted by the voltage flowing through.

The mechanism developed for the M-R Type 29 twin arc broadside controls each pair of carbon electrodes, independently maintaining the voltage drop across each pair of electrodes at 35 to 40 volts, and the feed of each pair of electrodes is independent of the other and controlled by the voltage drop in the arc that the mechanism controls. This is a schematic diagram showing the method by which this is accomplished. Each carbon arc has its lower carbon electrode in a fixed position. The upper carbon electrode is movable; and when no current flows, the lamp is in contact with the lower carbon. When the lamp is connected to the line, the circuit is closed with only the ballast resistance to impede the flow of current.

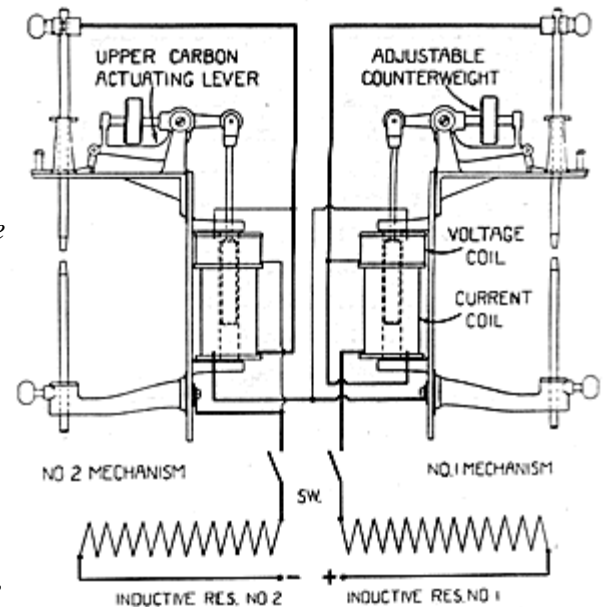

The current coils of each mechanism are in series with each other and with the two arcs. The current from the positive side of the line passes through the ballast resistance, 1, into the base of the lamp, through the switch to the control coil of mechanism No. 1, and on to the upper carbon; thence to the lower carbon, into the current coil of mechanism No. 2 through the coil to the other upper carbon, then to the lower carbon, and back to the line through the ballast resistance, 2. The energizing of the circuit actuates the solenoid armatures, which, through their connecting linkages, elevate the upper carbons in each arc system, striking both arcs.

Above each current coil, and surrounding each armature, is a coil wound with fine wire and a large number of turns, connected across the arc controlled by it. These coils are wound counter to their respective current coils, and the instant the arc is struck a small current flows through each coil. Since they are shunted across the arcs, the energy introduced into them increases as the voltage drop of each arc increases, the magnetic flux of each voltage coil opposing that of its corresponding current coil. By properly proportioning the number of turns in the current and voltage coils, and proportioning and spacing their respective armatures, it is possible by this method to control the opening of the arc and to maintain quite accurately a uniform voltage drop across the arcs.

A solenoid is a type of electronic piston where the plunger goes back and forth in response to the amount of voltage of current that is applied to it. These devices are extremely common and found in countless electric and electronic components for decades back. Every car will have a number of them. The key will be engineering a simple yet effective feed mechanism using ones found in scrap.

Offered by [Brian](#)



Troubled Times



Solenoids

Since the carbon rods in an arc are consumed during the process, the rods need to be moved continually closer to each other. Various clock-like mechanisms were developed, but a simpler mechanism used in the early days involved [using the voltage](#) to determine whether an adjustment was needed.

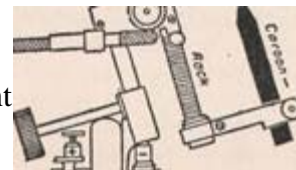

The relation between the current, the carbon P.D., and the length of arc in the case of the direct-current arc has been investigated by many observers with the object of giving it mathematical expression.

Let V stand for the potential difference of the carbons in volts, A for the current through the arc in amperes, L for the length of the arc in millimetres, R for the resistance of the arc; and let $a, b, c, d, \&c.$, be constants. Erik Edlund in 1867, and other workers after him, considered that their experiments showed that the relation between V and L could be expressed by a simple linear equation, $V = a + bL$.

Later researches by Mrs Ayrton (Electrician, 1898, 41, p. 720), however, showed that for a direct-current arc of given size with solid carbons, the observed values of V can be better represented as a function both of A and of L of the form $c - FdL$ $V = 38.9 + 2.07L + A$. There has been much debate as to the meaning to be given to the constant a in the above equation, which has a value apparently not far from forty volts for a direct-current arc with solid carbons. The suggestion made in 1867 by Edlund (Phil. Mag., 1868, 36, p. 35 8), that it implied the existence of a counter-electromotive force in the arc, was opposed by Luggin in 1889 (Wien. Ber. 98, p. 1198), Ernst Lecher in 1888 (Wied. Ann., 1888, 33, p. 609), and by Franz Stenger in 1892 (Id. 45, p. 33); whereas Victor von Lang and L. M. Arons in 1896 (Id. 30, p. 95), concluded that experiment indicated the presence of a counter-electromotive force of 20 volts. A. E. Blondel concludes, from experiments made by him in 1897 (The Electrician, 18 97, 39, p. 615), that there is no counter-electromotive force in the arc greater than a fraction of a volt. Subsequently W. Duddell (Proc. Roy. Soc., 1901, 68, p. 512) described experiments tending to prove the real existence of a counter-electromotive force in the arc, probably having a thermo-electric origin, residing near the positive electrode, and of an associated lesser adjuvant e.m.f. near the negative carbon.

This fall in voltage between the carbons and the arc is not uniformly distributed. In 1898 Mrs Ayrton described the results of experiments showing that if V_1 is the potential difference between the positive carbon and the arc, then $V_1 = 31.289 + 3.1L - A$ and if V_2 is the potential difference between the arc and the negative carbon, then $V_2 = A$ where A is the current through the arc in amperes and L is the length of the arc in millimetres.

The total potential difference between the carbons, minus the fall in potential down the arc, is therefore equal to the sum of $V_1 + V_2 = V_3$.

$V = a + bL + A$ In the case of direct-current arcs formed with solid carbons, Edlund and other observers agree that the arc resistance R may be expressed by a simple straight line law, $R = e + fL$. If the arc is formed with cored carbons, Mrs Ayrton demonstrated that the lines expressing resistance as a function of arc length are no longer straight, but that there is a rather sudden dip down when the length of the arc is less than 3 mm.

The constants in the above equation for the potential difference of the carbons were determined by Mrs Ayrton in the case of solid carbons to be - Hence $V_3 = 38.88 + 22.6 A^3 I L$ The difference between this value and the value of V , the total potential difference between the carbons, gives the loss in potential due to the true arc. These laws are simple consequences of straightline laws connecting the work spent in the arc at the two electrodes with the other quantities. If W be the work spent in the arc on either carbon, measured by the product of the current and the potential drop in passing from the carbon to the arc, or vice versa, then for the positive carbon $W = a + bA$, if the length of arc is constant, $W = c + dL$, if the current through the arc is constant, and for the negative carbon $W = e + fA$. In the above experiments the potential difference between the carbons and the arc was measured by using a third exploring carbon as an electrode immersed in the arc. This method, adopted by Lecher, F. Uppenborn, S. P. Thompson, and J. A. Fleming, is open to the objection that the introduction of the third carbon may to a considerable extent disturb the distribution of potential.

The total work spent in the continuous-current arc with solid carbons may, according to Mrs Ayrton, be expressed by the equation $W = I I.7 + 10.5L + (38.9 + 2.07L)A$.



Troubled Times



Enclosed in Glass

From the **Electric Museum** website.

What is an "enclosed" arc lamp? The arc is enclosed by a small oblong inner globe which is almost airtight. After a few minutes of operation the oxygen inside this globe is consumed, thus greatly extending the life of the carbons. These types of lamps could burn for up to about 80 hours on a single set of carbons, whereas earlier "open" designs needed their carbons changed every few hours. Walking along a city street in the early 1900's you never would have guessed that the ornate lamps overhead housed machinery designed to regulate and maintain a superheated plasma arc. Remarkably, this technology was in large scale use by the late 1870's long before the lightbulb was a commercial reality.



Troubled Times



Child's Play

An excellent source of carbon rods are the center posts of any standard disposable AA, C or D battery! (ever wonder what to do with all those "useless" batteries in the Aftertime?). I remember hooking a pair of these rods up to a 12 volt model train transformer when I was a kid, just to see the show. Keep in mind that the other compounds in the battery are caustic, so keep them off your skin and be sure to wash the carbon rods off before you handle them.

The result was light. Remember the old carbon arcs were used for movie projection systems for years, since it was the only source of light bright enough at the time.

All I did was wrap the tips of exposed doorbell wire around the ends of the carbon rods and plug it in. The proper gap needs to be maintained between the rods to get that brilliant spark, and it may not be like the movie theaters at only 12 volts, but it was light, **beautiful bright white light**. Puts off some smoke, but I did this in a bedroom without running everyone out. Remember I was only 12 or so, and that was a long time ago. I doubt it was enough light to compete with today's metal halide bulbs, but it was light sure enough, which beats the heck out of darkness. Need some kind of feed mechanism to adjust the gap, but this could be two blocks of wood with holes drilled to hold the carbon rods adjusted by hand if necessary.

Offered by [Ron](#).



Troubled Times



Constructed

If one studies the subject one finds the following key design considerations:

- Using hard graphite carbon rods (made like pencil leads) and a voltage of 45 to 60 volts with about 2 to 10 amps DC in a semi-closed environment (behind glass, with controlled air flow) consumes the least amount of carbon rod.
- DC works best but AC can be used. Current is limited by use of resistor (DC) or Inductance (AC). This is necessary because of the negative resistance characteristic of the arc.
- With this in mind, for testing Carbon Arc I purchased two surplus small 70 Volt (open circuit) output transformers that worked on 120 Volts input. Each one weights about 2 lbs. I wired them in parallel for input and output windings (to give more power) and put a 5 ohm power resistor in series with the 120 volt input winding. The 5 ohm resistor is to give short circuit protection to the transformers. The short circuiting the output causes the current flow for input winding to be 6 amps.
- By using jumper clip leads carbon poles from small dry cells and pencil led was tested. One could strike an arc by bring the ends together, and then separate the electrodes to produce a carbon gas plasma wider arc. The pencil led was a bit thin and didn't last long. It would get red hot along its length while in operation. This indicated it was running way over current for its small size. Lots of white light was produced when in operation but for a short time.

Offered by [Mike](#).



Troubled Times



From Scratch

Carbon Arc electrode making is difficult to accomplish. It becomes the go or no-go deciding point as to workability for any one attempting to use Carbon Arc lighting. I consider my attempts at this to be a failure. I tried baking several types of mixture of ground charcoal and liquid material that should turn to carbon if heated. I tried individually at separate times oil, sugar, and wax as the binding agent. I had read that pitch was used as a binder at some point in the past. In my testing the mixture was then heated over an electric stove burner. I could get it to harden but not conduct electricity. It also was too porous. It needed compressing and heating at the same time. It needed to be hotter than my red hot electric stove would make. Also the hotter it got the more it would burn and turn to ash. It needed to be in a closed environment under pressure.

Next I was going to try to use 50% ground up charcoal and 50% lamp black (soot from chimney or incomplete burning), and 10% clay and water or ground grain (flower) and water. Heat it in one end of a .5" SS tube pack in more from other end (use a packing rod) as heat dries and fuses it into a rod that comes out the other end. I never made this test. It became beyond my current skills. From studying patent info I doubt I could heat it enough to work. Other possible components that would turn to carbon but were not tested are: Wax, fat, sap, pitch, tar, bug-juice, ground up coal, oil, milk, eggs, gelatin, cotton strands mixed in for reinforcing, or other carbon producing material.

Offered by [Mike](#).



Troubled Times



Manufacturing

Where pencil leads work, as Carbon Arc electrodes, they burn out quickly. Carbon Arc became a commercial venture only after [Manufacturing Techniques](#) were developed.

Davy used for his first experiments rods of wood charcoal which had been heated and plunged into mercury to make them better conductors. Not until 1843 was it proposed by J. B. L. Foucault to employ pencils cut from the hard graphitic carbon deposited in the interior of gas retorts. In 1846 W. Greener and W. E. Staite patented a process for manufacturing carbons for this purpose, but only after the invention of the Gramme dynamo in 1870 any great demand arose for them. F. P. E. Carre in France in 1876 began to manufacture arc lamp carbons of high quality from coke, lampblack and syrup.

Manufacturing the rods is a complex process involving high heat, not something an Aftertime community could readily setup, as this description from the [National Carbon Projector](#) bulletin shows.

The following pages were scanned from a National Carbon Projector Bulletin from 1964 Published for Motion picture projectors, the process is the same for Searchlight carbons The bulletin will give you an idea of the costly process involved in making these carbons for searchlights

of meticulous and endless research and rigid quality-control manufacturing in American industry.

As is true of any quality product, the manufacture of arc carbons begins with careful selection and preparation of raw materials. In general, their principal ingredients are: petroleum coke derived from the refining process, lamp black, graphite, and rare-earth compounds that provide the special qualities of the light. Pitch materials are used to bond the particles together.

In the following 14 steps and their accompanying illustrations you are shown the major production phases each and every NATIONAL projector carbon must pass through before it is ready for packaging and shipment from Fostoria:

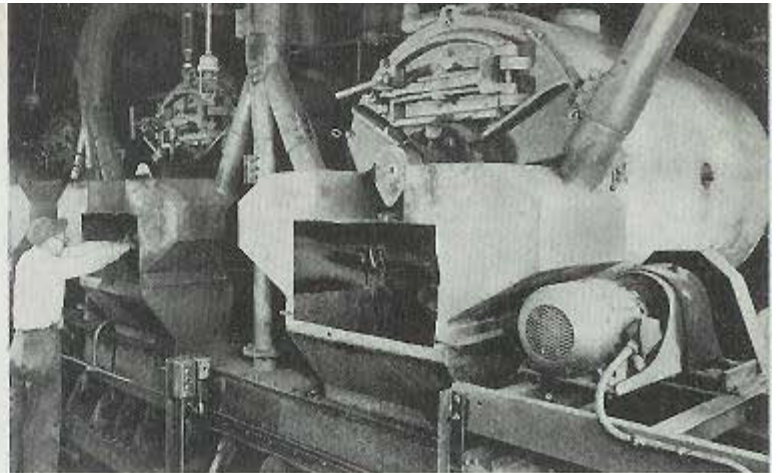

2. Blending of materials

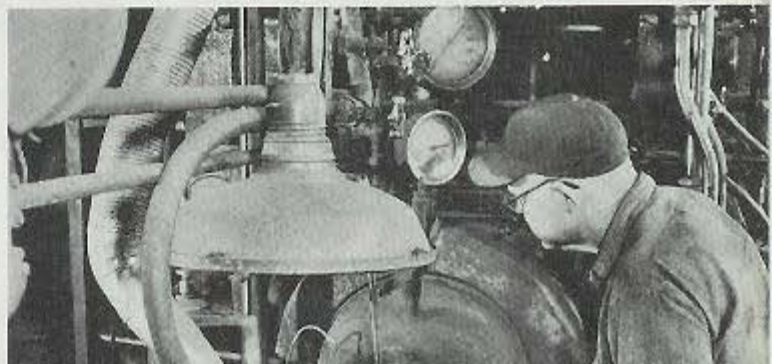

1. Following a series of milling and

1. Following a series of milling and screening operations, petroleum coke is reduced to the particle size required for a given grade of carbon. This dry material is then conveyed to storage bins from which exact amounts are drawn into hoppers accurately weighed on automatic scales.

2. Pitch materials in a dry condition are also weighed automatically. Whatever the grade of carbon being produced, its precise formula in the quantity required flows by gravity to steam-heated mixers for thorough blending.

3. With the carbon materials and pitches thoroughly mixed and heated to a fluid state, the final material is fed into the cylinder of an extrusion press. Like toothpaste from a tube, the material is squeezed through a die by the pressure of a hydraulic ram.

4. The hollow carbon rods are cut to prescribed lengths and carefully checked for size. This is but one of approximately 60 quality control inspections and tests arc carbons undergo on their way through the total manufacturing process.



3. Extrusion of hollow carbons

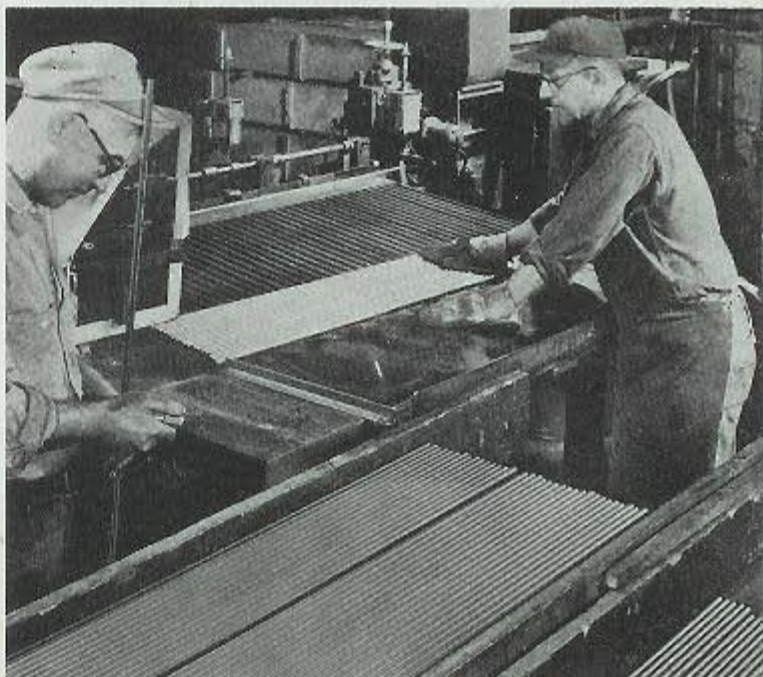

4. Cutting to proper length



Troubled Times



Carbon Black

Carbon rods for arc lighting can be made from carbon black*. Below are some carbon black links.

Offered by [Michael](#).

*Carbon black is produced from "sour" gas - natural gas that contains more than 1 grain of hydrogen sulfide or more than two grains of sulfur per hundred standard cubic feet.

To make carbon black, natural gas or other carbon compounds are burned in a limited amount of air to give a thick, black smoke that contains extremely small particles of carbon, which can be collected when the gas is cooled and passed through an electrostatic precipitator.

<http://education.jlab.org/itselemental/ele006.html>

Amorphous carbon is formed when a material containing carbon is burned without enough oxygen for it to burn completely. This black soot, also known as lampblack, gas black, channel black or carbon black, is used to make inks, paints and rubber products. It can also be pressed into shapes and is used to form the cores of most dry cell batteries, among other things.



Troubled Times



Battery Cores

The Zetas state that battery cores are *the* source for rods in the Aftertime. Think of how many batteries get used, and discarded, and are laying about amid the molder in land fills! It is the older batteries, in the main, that had carbon cores.

Desperate communities, running out of supplies of almost everything and turning to some of the skills of the past such as black smithing, will within years of the pole shift start to mine land fills. Where this seems a disgusting concept, landfills are filled with various metal parts, and this will be at hand and far more efficient than mining, which requires minerals in the ground locally. A local land fill will have a wide spectrum of metals, and will also have an abundance of battery cores. Where have all those used batteries gone over the past few decades? They do not rot, the casings rust and the chemicals wash way, and there they are! Thus, any community putting up a wind or water wheel to generate electricity, and wanting the daylight equivalent that carbon arc supplies, will already be stocking up on carbon cores. Windmills, almost invariably, will not be from store purchased sources, but cobbled together from parts. Electrical parts from garages and workshops will supply some of the permanent magnets, but this will also be something sought after in land fills. What do you suppose people have done for years, with worn out drills and the like? They toss them!

ZetaTalk

Offered by [Nancy](#).

Note: Alkaline, Mercury, Nickel-Cadmium, Gel-cells and Lead-acid batteries do not use carbon. You will need to use the old fashion 1.5 V standard cell. Use plastic or rubber gloves to avoid chemical burns or allergies with battery chemicals. One way to get it open is to saw it with a hacksaw down the seam on the side and pry it open till one can use a pair of pliers one each side to separate the sides from the bottom and top.

Offered by [Mike](#).

If you look at the ace hardware link, you'll see at the bottom of the ad that the batteries are Carbon zinc:

<http://www.acehardware.com>

And here's where a lot of batteries are sold: [http://batteriesandbutter.com/Merchant2/merchant.mvc?](http://batteriesandbutter.com/Merchant2/merchant.mvc?Screen=CTGY&Category_Code=hd)

[Screen=CTGY&Category_Code=hd](http://batteriesandbutter.com/Merchant2/merchant.mvc?Screen=CTGY&Category_Code=hd)

Folks stocking up for the shift, should buy heavy duty Carbon Zinc batteries only - as they are the least toxic and provide carbon cores after their power is exhausted.

Offered by [Brian](#)

Some good information on a possible [Alternative](#) to those breakable light bulbs. If you know what you're doing and want to test this out, you can get carbon rods by cutting open your average d-cell battery and wiping the corrosive gunk off the rod. Follow the link for more information - it's very detailed.

Offered by [Gabe](#).



Troubled Times



Consumption

When I was doing my electricians training in my dim distant youth, prior to later upgrading to Electrical Engineering, the company I worked for had developed some Arc heating which gave off good lighting. But this is a wasting process and a *very* heavy consumption of power. I do not think it is really an option for lighting under any conditions.

Offered by [Darryl](#).

In general I think carbon arc lighting would be used for extreme emergency only. This is because of the consumables needed and the low efficiency of light production.

Offered by [Mike](#).

Carbon arcs are energy intensive requiring large amounts of current for the light produced. I feel a better use of the battery core carbons would be to produce a high temperature arc furnace for reducing metals for casting. As a low tech approach to melting metals for casting they excel. A couple of carbon rods, a clay pot and electricity are almost all you need to make a pretty good furnace for heating and melting lead, aluminum and other non exotic metals.

Offered by [Ray](#).



Troubled Times



Purchased

[Carbon Arc](#) and their parts are available on the web, and for sale on eBay! Just [Ordered](#) four of these rods. They are 12 inches long, half inch in diameter. I am *very* curious to see how much continuous arc can be had with these. If one can get 24 hours - that's two hydroponic days. Cost - six dollars a day. The price drops quite a bit if you buy in bulk - just \$3.62 apiece if you buy 100 or more. Depending on just *how long* a pair lasts will determine how wise a bulk investment in these would be. Imagine if you could get a *week* out of a pair! Then if someone bought a thousand of them, they'd have carbon arc for quite a while!

Offered by [Brian](#).

Carbon arc rods with copper coating around them are also available though local welding supply houses.

Offered by [Mike](#).



Troubled Times



Pros and Cons

1. AC requires more push to get through the lines, thus wastes precious power

I assume that the word "push" equates to "voltage". If one assumes that the comparison of AC to DC is assuming the same line material (copper), line diameter, and line length, then this statement simply isn't correct. Both AC (at low frequencies like we use at home) and DC abide by the same laws of physics. This is commonly referred to as Ohm's Law, which is $I=E/R$; that is, current (I, amount of electricity) is equal to voltage (E or "push") divided by resistance (R or "the ability to impede" the flow of current). Thus, if E and R are the same in our comparison of AC and DC then "I" (amount of electricity) will also be the same.

2. AC devices assume the voltage from the grid

I am assuming that by "grid" we are talking about the set of electric "lines or wires" that distribute the electricity from it's source to the various places where it will be used.

If my assumption is correct, then the statement is incorrect. The AC that we use in our homes leaves the source - generation plant - with a voltage of many thousands of volts. It is then distributed to a series of substations which, using transformers, ultimately reduce the voltage running along the power lines along the street to several hundreds of volts. Finally, atop every few "power poles" you will find still another transformer which finally reduces that "several hundreds of volts" to your normal 115-120 volts AC that comes to your individual house (of course, the exact numbers are different in different parts of the world).

Were DC used at the generation plant for distribution such a long distance, *hugh* diameter power lines would be required to minimize the R value, *and* transformers could not be used as they only work with AC. Therefore you would have *very much* higher voltages coming into your home.

3. DC devices such as made for camping require less push

Correct because the DC source ...battery... is only a few feet away. The largest RV's I've seen are 5th wheel campers no longer than around 45 feet.

4. DC conserve energy, especially when the production and use are same locale

The key word is "same locale". To go any distance you need very large wire or AC and transformers. Transformers do "waste" a fraction of the energy. It is a "trade off".

5. DC camping lamps and heaters and whatever use 12V

True except for heaters; at least my RV didn't use 12V for the heater except for the fan. Also, when I put my "made for RV" refrigerator (which generates heat to make cold!) on 12V mode, even while on the road and the battery was charging from the truck generator, the RV's deep cycle 12V battery bank was still depleted.

6. AC and high voltage are *dangerous* for family group to try to produce (read electrocution)

No need for AC and high voltage if the source is close to where it will be used. Otherwise I would suggest that one read a little history on the subject of DC vs. AC for distribution. Whether AC or DC, for practical wire size High Voltage is required. Edison first lit parts of New York City with his new electric lights using DC. Death rates were enormous because of very high voltages hanging over the streets and sometimes falling and going into homes where accidents happen. If one does accidentally get hold of a high voltage DC line, one can't let go; where with AC the opposite is true. Westinghouse developed AC and went into competition with the Edison Electric Company and in short order DC was relegated to low voltage battery applications.

Offered by [Ron](#).



Troubled Times



Both

A good solution is to go with DC generation. First off, you can store DC electricity in batteries which means you can generate the electricity when it is convenient for you and use as needed. Next, you have the options of going with high voltage DC (depending upon the load) or low voltage which is safer, and inverting it to AC where needed. Today's inverters are inexpensive and bulletproof. Plus, they give cleaner electricity than you can buy from the grid and they are not cycle sensitive. All this means that you have good surge capabilities and you can use efficient appliances, along with the luxury of operation sensitive equipment like a computer without worry.

A person is better off buying items like inverters and batteries from experts in these fields who can supply adequate support and promise a good price. Inverters normally range from \$.30/watt to \$1.00/watt. Batteries go for \$.10 to \$.30/watt hour and come in various types so that only an expert can determine what best for you. Remember, that application is the key and there is no "one size fits all" system. That's only common sense.

Offered by [Glenna](#).



Troubled Times



Simplicity

12V systems are currently the cheapest and most practical as far as storage is concerned - an associate of mine was telling me that from wholesale sources car batteries can be obtained for ten or fifteen dollars. Electricity can be generated from windmills, sunlight, or even human power and can be used to charge a battery using very simply electronics. Converting 12V DC to 120AC is more difficult, but commercial units are available. The downside is that eventually any kind of battery is going to wear out and won't recharge any more.

Offered by [Michael](#).

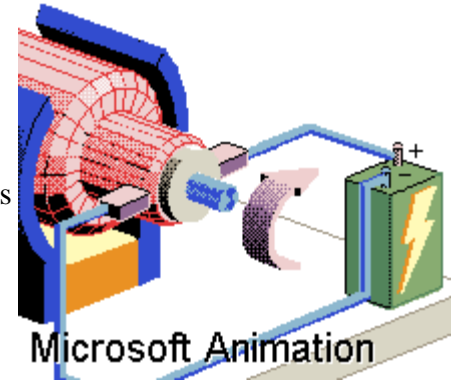

Troubled Times



Less Maintenance

All devices, AC or DC, assume some voltage regardless of the source - off the grid or from an inverter. Your computer operates on 120V, and this is its assumed voltage. This assumed voltage is important. Use a higher voltage and you'll burn it. Use a lower voltage and it won't work. It is of no importance if you connect it to a wall socket on 120V or connect it to 12V UPS via an inverter that transforms the voltage into 120V.

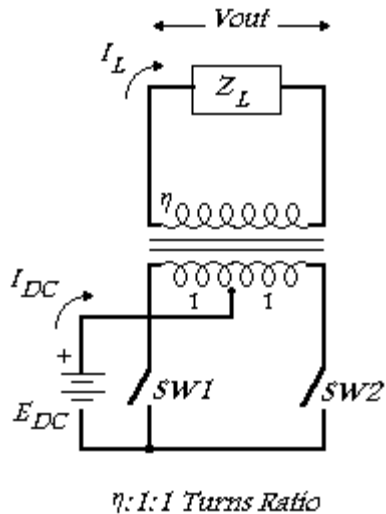

The problem is not getting connected via inverters. It's currently a minor problem to connect 120V light bulbs to 12V batteries. If you have the batteries and the inverter - there you go. But in the Aftertime there will be a major problem with reserve parts. You have to assume your inverter will break, so you need a reserve inverter. If you don't have it, or the last one goes down, your batteries and light bulbs are useless. If you plan to use 12V batteries and 12V light bulbs your dependencies are much lower.

Thus, using all equipment with the same assumed voltage allows you to improvise much more than if you depend on inverters and transformers. And this is the main reason I recommend this approach, not because stepping up to 120V can't be done.

Offered by [Kiko](#).



Troubled Times



Monitors

Besides the flat LCD screens, is there any other way to make a monitor run on DC?

[Helena](#)

Yes, use a DC to AC inverter as used in UPS's (Uninterruptable Power Source) and other types of sine and modified sine inverters units. I suspect many monitors will be broken in the polar shift. In this case Helena, there is a piece of technology that only you as a blind person can recommend. What is the best most easy to use speech software that can be used to run a computer when blinded with no working monitor? If each site were to have this software around, just in case, well it might just save the day for some.

Offered by [Mike](#).



Troubled Times



Exceptions

Are there any devices which absolutely, positively will not run on DC?

[Helena](#).

Yes, Induction motors (ones without brushes) as used in fans, compressors, refrigerators, washing machines, the motor part of (hair and cloths) dryers and some power tools will work only on AC. If you see brush caps on the motor (or can look into it to see the carbon brushes) as in sewing machines, some power hand tools these will usually work on DC or AC. Battery operated drills, saws, and other tools will work on DC. Filament light bulbs, electric water heaters, toasters, toaster ovens, coffee pots, heater element in dryers of all types will work on DC or AC. Electric space heaters with fans will only work on AC, those that only radiate heat with no fan will work on DC. LED's primarily work on DC but will work on AC if a power supply is used. Anything that has a transformer in it must take AC unless it has a connection that bypasses the internal power supply and is labeled with a given DC. This includes florescent lights, sodium vapor lights, mercury vapor lights, TVs, Microwave ovens, desktop PCs, and some radios. Some items like radios and ham equipment are set up to be able to take AC or DC. One needs check on the back of the unit to see what it will take. Sometimes the name plate on the tool or device will say it will work on AC or DC. Follow the proper voltages that are needed in all cases.

The quality of AC needs to also be discussed. Some things that have transformers in them like florescent lights will not work properly if the frequency gets over 100 Hz or drops too low below 50 Hz. Some inverters produce modified sine wave (closer to a square wave). This introduces a lot of harmonics and will not work very well for communications type equipment and heavy load starting capacitor start induction run motors (refrigerator, washing machines) tend to have problems starting.

Offered by [Mike](#).



Troubled Times



Close Proximity

With a DC system power generation needs to be very close to your dwelling. What if this isn't possible? There are many scenarios for this - wind on the top of the ridge but you can't get a house built there, or perhaps you have an underground dwelling. There may be sunlight for photovoltaics in a meadow some distance (maybe there will be some sunlight, as several of the Mayan events did not include loss of sunlight), or the stream where you have your power generator is not where you want to live because of possible flooding. You can get around this by using 4 gauge wire, or 2 gauge wire. Priced this stuff lately? Its expensive. The other method is to use 6-10 gauge wire to boost the voltage to 160 volts or multiple modules wired in series, and then using a switching transformer (Todd Engineering makes one for \$84-250) to lower the voltage to 12 volts to charge your batteries.

Offered by [Michael](#).

Keep in mind that DC power attenuates if you run it longer than a distance of 30 feet due to the built in capacitance and inductance of the medium you are conducting it with. AC power can be propagated for much longer distances with very little attenuation. There is a tradeoff. If indeed you lose power with AC to DC and DC to AC conversions, it might only be a small fraction compared with using DC over long distances.

Offered by [Kurt](#).

If your going to use large DC consuming devices you should probably reconsider your no AC decision. Low voltage DC is actually more difficult to use in large quantities. The wiring of low voltage, high current DC devices is critical to prevent power loss and fires. When you factor in the cost of heavy gauge wires, connectors and the other necessary components of your pure DC system you may find the cost surprisingly high. When I chose to go with AC as a major part of my electricity plan I simplified many other plans and devices. The vast supply of inexpensive but high quality AC powered equipment far exceeds the amount of DC equipment available at what I consider affordable prices.

Offered by [Ray](#).



Troubled Times



Steady Source

Wind power uses batteries to level out the power during changing wind conditions. To generate the same high voltage AC for a slow wind becomes a technology challenge without a battery buffer. One can do better with hydroelectric power and AC only is probably possible and appropriate. A constant flowing water source can produce near constant AC. Not everyone will be near a water source. The water flows will change after the pole shift. One needs to handle the distance that the power will need to be brought in from. Both of these are subject to tampering with or destruction by passing hungry gangs. Keeping these going for 20-30 years will be a challenge. I don't yet know where one can buy a small safe nuclear power plant or fuel cell. What are our other alternatives from your prospective?

Offered by [Mike](#).

Many of the items you mention are quite durable and will not need to be replaced frequently. Choice of technology is critical, you must ask: Can I build this? You mention brushes. Brushes are used on small DC motors, the ones you'd have to use with a low voltage DC power supply. There is a reason industry uses AC motors, they are durable, energy efficient and require very little maintenance. You can store energy by pumping water. One scenario would have wind powered pumps moving water from a low energy reservoir to a high energy one. You can then get steady hydroelectric power from the high energy reservoir, the capacity of the reservoir is all you need to smooth out dips in the wind. Pumps, generators, motors, compressors, air powered tools and appliances, can last for years, can be rebuilt, and can be manufactured using low tech methods. We definitely won't be doing things the way we do now.

Offered by [Steve](#)



Troubled Times



AC Generators

Gasoline and diesel engine AC generators can cause one annoying problem. They can frequent burn out sensitive lighting equipment. If for example one finds that the ballast in florescent lighting is burning out frequently, then measure the AC Voltage of your generator under a typical load. More than likely you will find the voltage is well above normal.

The speed of the engine must then be adjusted at the carburetor. Some times a tab (with spring going to the throttle valve) needs bending other times it can be adjusted by a screw. Loosen lock nut and adjust throttle running speed screw for a speed that gives the normal voltage. This screw typically has a spring that goes to the throttle butter fly valve. The voltage should be between 115volts to 120 Volts for USA power.

Don't worry about frequency. Most items are not sensitive to frequency. If you want to measure frequency then compare an AC clock to a battery operated clock over 100 minutes and compare the times of both. Running slow on AC would indicate lower than normal frequency.

Example: Of the 3 small backup gasoline generators at our remote survival site only one was adjusted from the factory close to 120 volts. One was found to be as high as 135 volts and was knocking out florescent shop light ballasts frequently. What we found was the surging of the engine when the generator was running out of gasoline, along with the higher running voltage of 135 volts, was enough to knock out the florescent light ballasts.

One should attempt to shut off the generator before it runs out of gasoline. One can set a timer to remind when to shut it down. The surging that goes on when it runs out of gasoline is not good for all items turned on at the time. However, if one keeps the voltage at or below 120 Volts at the generator then in most cases most items will not burn out if occasionally you run out of gasoline.

Offered by [Mike](#).



Troubled Times



Startup Current

When generating electricity, we usually overlook the efficiency of the load we plan operate. In AC applications, this load can be dramatically different from a DC application. For instance, a person may have an AC diesel generator or steam powered AC. generator and nothing else. They would find that many loads such as fluorescent lights and capacitor motors have huge startup currents. Even though they have 1000 watts of fluorescent lights and a refrigerator(800 watts) and a washing machine with a 1/2 hp motor (1200 watts) and the entertainment center (500 watts) for what seems a total load of 2500 watts; they would find that when the well turns on or the washing machine turns on that their 5000 watt generator is not enough. that is because the electric motors require 3-4 times the normal current to start up. Also, if the cycles get interrupted, the fluorescent light will go into start mode again and double their current. This means that they really need a generator of 10,000 watts to operate a 2500 watt load! The money could be better spent on simple cheap incandescent lights and efficient brush type motors.

Offered by [Glenna](#).



Troubled Times



Inverters

A power inverter is used to convert 12 DC battery voltage to 115 V AC. I went to a local ham swap meet today and noted that the Whistler power inverter was commonly being sold. Prices for new units at the swap meet were running:

500 watt continuous	PP500AC	\$99.95
1000 watt continuous	PP1000AC	\$219.95
1500 watt continuous	PP1500AC	\$324.95
2500 watt continuous	PP2500AC	\$544.95

Prices on the web, such as [Shipman Enterprises](#), are higher. I suggest you shop around for lowest price if you decide to purchase this brand. More research is needed to determine if these are the best units to use.

Offered by [Mike](#).

In theory you can run ANY PC or AC electrical device from a DC source. You just need the use of an inverter. An inverter takes 12 volts DC and converts it to 115 volts AC. A car battery would be the perfect source for your 12 volts. You can find some [Inverters](#) on the web.

Offered by [Kurt](#).

Power system inverters and controllers. I recommend [Trace](#). Again, wholesale pricing on these items is well below retail so find an electrician buddy or purchasing agent to negotiate the best price. Trace equipment specs can be found on the web.

Offered by [Gary](#).



Troubled Times



Switching

Using inverters is of course a possible solution if DC equipment is not available. However, AC devices are not always designed with power savings in mind. Furthermore, there will be a power loss in the DC to AC inverter, and another power loss in the AC to DC power supply. And devices specifically created for DC tend to be less power hungry. Alas, native DC solutions will be superior post-pole shift. Going for DC instead of AC, taking smaller windmills in consideration, will affect the whole power supply planning. Examples are:

- Amateur Radio Power Amplifiers like the 1 kW ICOM-PW1 require a minimum of 90-132 V AC at 20 A for 500W output, 180-264 V AC at 15A for 1 kW. Trying to run this monster on a car battery with an inverter would drain the battery immediately. Instead, using the built-in 100 W PA which runs on 12 V (13.8 V to be exact) may be sufficient, since the radio frequencies will be much less crowded than today. At 20 A, this would require 2 * 100 Ah batteries in parallel.
- One recommendation I've received warns against my system thinking of running 30 kW windmills. Smaller and portable windmills to charge batteries only can be moved after the shift. My current thinking is to have one battery in each cabin (maybe the new Rolls 450 Ah model) and a number of surplus batteries that can be charged by the windmills. The charged batteries will then have to be carried to the cabins etc. For the Amateur Radio equipment, PCs etc., the batteries will likewise have to be carried to the individual buildings and rooms where the equipment is located.
- Smaller cabins may be wired for DC lamps, fridges etc. Larger buildings may have a DC wiring in place for a later replacement of the batteries with a source that is powerful enough to overcome the attenuation.
- Instead of using electricity for cooking, wood stoves may be the best short-term solution.

In other words, going for battery supplied DC instead of grid supplied AC will require specialized devices as well as careful planning.

Offered by [Jan](#).



Troubled Times



Inverter Choice

Three power inverters were tested to measure the DC power usage when no AC Power was being used. In other words this is wasted power while on but not in use. All of the inverters were purchased from <http://www.harborfreight.com/>. Search on the Item number to find them.



91813-2VGA

Chicago Electric Power Tools 60 WATT CONTINUOUS/100 WATT SURGE PLUG-IN POWER INVERTER \$13.99

Measured 1.46 watts usage at no load or at 60 watts about 2.45 percent wasted power.



92708-4VGA

Chicago Electric Power Systems 400W/800W MODIFIED SINEWAVE POWER INVERTER \$39.99

Measured 5.2 watts usage at no load or at 400 watts about 1.3 percent wasted power.



91848-7VGA

Chicago Electric Power Systems 700 WATT CONTINUOUS/1800 WATT SURGE POWER INVERTER \$89.99

Measured 11.8 watts usage at no load or at 700 watts about 1.7 percent wasted power.

Bottom line summary: As a rule of thumb one can expect about 2.5% wasted power for low power inverters and about 1.5% wasted power for higher wattages units. To minimize power usage when using inverters do the following.

1. Turn the inverter on only when you need to use AC power.
2. Use the smallest continuous rated wattage inverter that will do the job at hand. This minimizes wasting of power.

As an example: One should not use a 700 watt inverter if all one needs is 40 watts. Use the 60 watt inverter and save the difference or $11.8 - 1.5 = 10.3$ watts

Offered by [Mike](#).



Troubled Times



Step Up

Do you know of any way to provide 8 amps of power and 220V of electricity through the use of inverters? I am looking for a way to use our submersible well pump periodically using auto battery power.

Clayton

Trace makes several models that will provide 220 volt AC. There may be other brands that will work as well. 220 volts AC is common in Europe and there may be another manufacturer that specializes in these. You could also take a 110 Volt AC output from an inverter and use a 1:2 step up transformer to get 220 Volts AC. Another way would be to replace the sump pump with a 24 Volt DC or a 110 Volt AC version. Probably using a 220 Volt inverter is the most cost effective since you already have the pump.

Offered by [Mike](#).



Troubled Times



Auto Alternator

I'm wondering if it is at all possible to get 120 / 240 volt AC single or three phase current from an auto alternator.

[Mike](#)

Yep, you can. I would be happy to answer any questions that you might have in this if you want. Try this site if you desire to see this being done by someone already;

<http://www.qsl.net/ns8o/welcome.html>

Spinning an alternator faster will give you more voltage, but one must consider that you are affecting the frequency as well. The faster it goes, the higher the frequency. Now when in use with the diodes in the alternator, it does not matter. Nor does some equipment that you may be powering care about it. But frequency dependent equipment, such as Florescent lighting, Televisions, and electronic equipment will have a cow with it. The best thing to do is up the amount of field current for it, but even that has limitations (as it was originally not wound for it). A simple formula for determining how fast to spin the alternator is to know the amount of poles in the alternator (I presume you desire 60hz AC);

$$\text{speed} = (\text{Hz} * 120) / \text{poles}$$

Hence a typical auto alternator of 6 poles (a Delco I have) would be required to spin at 1200 RPM for 60 hz. Now, at that frequency, if you place more current on the field, you could "adjust" the voltage to suite you. You might also want to consider reconnecting the typical "Delta" wired connections in the alternator to a "Star" configuration so that the current in the field would not have to be so high.

Anonymous

Frequency dependent equipment, such as Florescent lighting, Televisions, and electronic equipment will have a cow with it. Oops, I forgot something. Before someone says something about "I run my TV on 100 hz and it's ok", I need to add something. Yes, you can run some TV's at higher frequencies as well as some stereo's. It is dependent upon the equipment having a transformer, stepping down the voltage and using DC voltage for running the main circuitry off of this voltage. A good part of modern units sold today do this. However, my point remains.

Some electronic circuitry uses the input line frequency timing for operations, such as vertical refresh, clocks, etc. If the input frequency is not 60hz, timing will be affected. For some equipment the only effect it will have is the clock will always be off, or the screen will have trouble sync'ing. Some units will be affected, but display nothing that the user can see. Others will work like a champ, while still others will go ballistic. Best choice is to look for a unit with a transformer, and try it, but be watchful of its operation.

Bruce

Yes, you need to do three things, assuming the alternator windings are not modified:

1. Bypass the internal diodes.
2. Change the field regulation so that your desired output is the setpoint.
3. Spin it much faster.

The third requirement could be avoided if you are willing to rewire the stator.

Marty



Troubled Times



3 Phase

Wind and water power probably use deep cell batteries. I know they last longer but are they harder to maintain or rebuild? Or are their different types of deep cell batteries?

Offered by [Jon](#).

How does one go about rewinding a 3 phase motor to use with low speed wind power? I had it on my list to order but haven't done it yet. Just last week I found a salvage place that sells these motors for \$.20/lb. I looked at a couple that must weight 150-200 lb. or more (440 volt). Assuming a primitive environment with minimal to no controls, if one used this approach in a stand alone mode for hydroelectric power, and floating debris partly blocks the screen on the inlet pipe to one's 3 phase AC motor turned generator so that the speed drops to half of the original speed, then one would expect to measure about 30 cycles at 55 volts with light bulb brown out observable at the time. Now if this generator were then synchronized with another 60 cycle stable source of power, and connected to it, then it would begin to act like a motor, and possibly pump water or burn up because it wants to stay at the 1800 RPM to sync with 60 cycle source. To properly connect a free running AC generator to a stable 60 cycle source of power one would need to get it going slightly faster than it's sync speed. This is so it can sync up and produce contributive power.

Offered by [Mike](#).

You can produce AC current using a 3 phase asynchronous induction motor in conjunction with water wheels. You must use proper sized capacitors (according to motor size). You will not be able to connect your load until the capacitors are saturated by the residual current created by the rotor. The beauty of these applications is that you can produce a useable 50 or 60 cycle AC current as well as charge battery banks simultaneously.

Offered by [Jay](#).



Troubled Times



Bench Test

This is a test bench procedure to see if any particular motor will work as an alternator, as not all will. The motor must be turning at around 1836 rpm. When the light shows normal luminance you can then connect it to a load. The battery *must* be removed just before you begin to turn the motor. If the light does not glow this motor will not work as an alternator.

Purchase a mechanical hand tach (no fuss, no muss, no setup) to make sure your generator will measure at least 2,000 rpm. The big boys use three phase induction motors in their wind turbines, but they are connected to the grid (with continuous load, within + or - 2%) on three phase lines and employ sophisticated electronics and or pitch mechanisms to maintain synchronous speeds. I wouldn't try using one in a small wind generator, as there are too many criteria to meet for reliable operation. You can use a horizontal shaft lawn mower engine, or a 2 hp. and above single phase motor for your driver. You can even use the power take off of a row crop tractor, as they operate at synchronous speed (1800 rpm.). You will not be able to test a motor that is the same size (hp.) or larger than your driver, and expect to get accurate results.

This will sound a little strange, but you can excite a three phase induction motor with an automotive battery (as long as it doesn't have an iron-aluminum composite rotor). It's best to have the motor set to operate on 220 or 240 volts. This means that each phase will produce 120 volts. Take the wires from one phase and connect this phase to an automotive battery for about 3-5 minutes. This imprints that region of the rotor next to the set of windings connected to the battery with a temporary magnetic field. Connect one of the other phases to a regular household light bulb (100 watts).

You need to be able to drive the motor you are going to use as a generator at about 5-7% above synchronous speed (this is the speed at which the line current revolves around the stator windings) - 1800 rpm. + 7% = 1826 rpm. Now after you excited the rotor, disconnect the battery and connect the two motors together and crank er' up. The light should begin to glow a little bit before the generator reaches 1826, at 1826 rpm. you should have normal luminance, if you don't, this motor won't work for power generation (this can happen for a multitude of reasons, but 8 times out of ten it will work).

You must be able to drive your generator under maximum load (data plate hp. rating x 746 watts. 5 hp x 746 = 3,930 watts). This is important because if you exceed this limit two things will happen. Depending on the design of the water wheel used (it will need to extract about 8 hp. from it's stream and no more for a 5 hp. generator) if this generator is continuously overdriven at maximum load it will eventually burn out the windings. If the water wheel can not drive the generator at 1826 rpm. it will drop out of current production. It's a precarious balance, but there are literally thousands of such applications here in the States. With proper electrical controls this system can be used in co-generation. As stated above it is intended for stand alone use.

Offered by [Jay](#).



Troubled Times



DC Generator

I used to do something like this back in the 50s through 60s. For the old car DC generators in use before alternators, often one needed to polarize it. This was especially needed if it wasn't used for a long time, or it had been taken apart to be fixed. This polarization was done by quickly zapping it with a battery directly on the generator output terminal to ground. I used the same polarity as was to be generated. This zap would provide enough residual magnetism in the right direction, in the iron field to get the generating process started with the correct polarity. Once rotation started any current generated would then strengthen the field coil magnetism and thus generate more current. The result was the DC generator back in operation. This process is not needed for permanent magnet generator-motors.

Your attempt at describing how to polarize a generator is appreciated, but it lacks the specific information necessary to do it correctly. For instance, "zapping" is non-descript, "zapping with the battery to ground" says nothing about what connection goes where or when.

Susan

Do not use this technique on alternators. Alternators generate their own field when in operation by use of 3-4 amps of battery flow. So it is not necessary for these. This technique can be used only on the old fashioned DC generators (used in cars earlier than 1960-1970's). One quickly flashes the battery across the generator using the same polarity as is normal in charging. What you are doing is bypassing the voltage regulator circuit. Some charging circuits use a positive ground and some use negative ground so I can not say what polarity you have. The result is a small residual magnetization of the iron in the field coils and armature, that allows the generator to start producing power once it starts to turn.

Offered by [Mike](#).



Troubled Times



2% Above Sync

The correct solution is to maintain 2% above synchronous speed. That's 1836 rpm. at 61.2 cps. Once you drop below synchronous speed you will loose all power. The capacitors will loose their saturation and drop off line. The battery is only used as a component for bench testing. If you were to use a battery in the working system that means it must be maintained and have extra circuitry to cut in and out at the proper times. Capacitors need no maintenance and operate automatically. The 61.2 cps. just means that your motors will run slightly faster @ 2% (frig, washer, dryer, etc.) no harm will be caused here, your local utility maintains 60 cps. at + or minus 2%. You will need to extract 8 hp. from the water wheel. That's the data plate rating + 60% 5 hp. + 3 hp. = 8 hp from the water wheel.

Offered by [Jay](#).

Why 2%? I am thinking that one could turn on two fans one much stronger and faster than the other. If the stronger fan blows the weaker fan in such a way as to tend to speed up the blade faster than it would normally turn (with the 60 cycle source tuning it as a motor), then to me this slower motor will resist being speeded up and start to flow current back into the 60 cycle source. Thus becoming a generator. This I believe to be true of almost any motor DC or AC. Am I wrong?

Offered by [Mike](#).

Mike, in this instance I was speaking of a stand alone application, using capacitors only for self excitation. If the above condition were to take place you would have a 5 hp. motor trying to drive a 5,968 watt load (8 hp. water wheel X 746 watts per hp. = 5,968 watts). This would most definitely trip any protection circuitry or burn the motor up. Most usually in applications of this nature two phases are used to supply 120 volt ac. line current for the home while the remaining phase is used to charge battery storage banks. You are unable to drive a three phase motor on a single phase line without modifications.

Every time you introduce a load in a circuit that the internal resistance of the alternator or generator increases in proportion to the load. This in turn lowers the rpm (this is how electric motoring brakes work). You must maintain an rpm near the *upper gross deadband* (the maximum output capable of any given alternator or generator before damage will occur). This is why motors have data plates. In a stand alone system you will have loads going on and off continuously and need this 2% to handle the ups and downs in current draw.

Offered by [Jay](#).



Troubled Times



Brownout

60% is the industry "rule of thumb" and allows some leeway but not much. Imagine operating a motor in a continuous "brown out". For the sake of argument lets say you have a refrigerator motor rated for 120 volts trying to operate with a 90 volt supply. Soon it will burn out for numerous reasons. An induction motor used as an alternator must have the proper sized capacitors for that motors hp. rating. When the rpm drops below the *lower gross deadband* (the lowest rpm at which usable power can be extracted, about 1820 for most asynchronous motors) The capacitors will loose their saturation and fall off line. Resistors can be used to lower this target, but it can create other problems as well. All of the AC motors that would appear in your circuit as a load require at least 55 cps. (washer dryer etc.) to operate without burn out. When the rpm. of your alternator drops so does the frequency. If you have a constant load applied (one should maintain a minimum load of about half the hp. rating in watts).

You must always have more power available at the power source, (in this case water wheel) in order to maintain proper load and frequency requirements from the current provider (alternator, 5 hp. x 746 = 3730 watts max. out). When the contactor on a load carrying device such as a refrigerator closes (capacitor start motor always under load) a momentary load of up to 8 times the data plate rating is required just to start such a motor. If you have a 1/2 hp. motor on your refrigerator this condition (1/2 hp. 373 watts x 8 = 2984 watts-load) along with the simultaneous operation of several other small loads can exceed the capabilities of your 5 hp. alternator (3730 watts) for a period of up to 3-5 seconds on average. You need the extra power at the water wheel to "push" through these brief periods of brown out as well as other obvious reasons. Have you ever noticed the lights dim in your kitchen when you hear the fridge start up? This is why, "local circuit brown out", and this happens when you have an inexhaustible supply of highly regulated current. It's a precarious balance.

Offered by [Jay](#).



Troubled Times



Slip Speed Ratio

One important aspect of power production using AC motors as alternator is *slip*. This is the relationship between the speed of current revolving around the stator windings (1800 rpm) for any AC motor here in the states and the actual speed of the rotor. I have always used the terms "synchronous or asynchronous motors", as their rotors revolve at synchronous speed (1800 rpm) and accordingly have little or no slip. Let us say for the sake of argument that you have an AC motor with a rated rotor speed of 1725. To have such a motor produce any usable power you must drive it beyond it's slip speed ratio. Here is how this is computed. First you subtract the rotor speed from synchronous speed $(1800 - 1725) = 75$, we now divide synchronous speed by 75 to get our ratio $(75 / 1800) = 24$, this is our slip speed ratio. To get the rpm where you will see actual power being produced you will multiply the slip speed ratio by 100 $(24 \times 100) = 2400$. Now to reach the *upper gross deadband* (that speed required to accommodate the motor's rated load in watts) we add 2% and come up with a rotor speed of $(2400 + 2\%) = 2448$ rpm. If done in this manner you will also see a sinusoidal sine wave of 60 cycles + or - 2% depending on load considerations.

It should now be obvious why asynchronous motors are most often used in such applications as they will produce usable power at a much lower rpm, about (1836 or so). By the end of 1999 there will be a paper made available from the University of Texas at Austin depicting the above technique in detail. I have been helping a graduate student there to produce single and three phase AC power simultaneously, using capacitors to self excite a three phase ac motor of the same rpm rating we have just discussed. Living in the sun belt he is using solar powered super heated steam to drive a steam engine for the primary driver.

Offered by [Jay](#).



Troubled Times



UPS

We have talked a lot about needing an inverter to take DC and convert it to 110 volts 60 cycle AC. We haven't mentioned much about UPS (Uninterruptable Power Source). In simple terms a UPS is a very fancy inverter that produces clean sine waves with in 3% to 5% total harmonic distortion (THD) at uniform volts and frequency. Most Inverters usually produce modified sine waves (MSW) which produce lots of harmonics 30% to 45% THD. Some items we will run can have trouble with this. MSW can cause buzzing noises in audio and radio electronics. Most laser printers will not run on MSW. Motors run hotter, less efficiently and some are harder starting on MSW.

The UPS technology is used a lot today with critical computers file servers, mainframes etc. The cooperate world tends to write computing equipment off the books every 3 to 5 years. These are then sold at junk prices and show up in surplus electronics scrap yards. These units cost plenty when new but when you buy them 3-5 years old they sell for very, very much less. To give you an idea of what you can find if you look. I bought a 1450 watt **American Power Conversion** (APC) Smart-UPS model AP2000 with batteries (48 Volt) for \$30 unknown condition. The **Silicon Salvage** place I bought it from didn't know if it worked or not they hadn't plugged it in. The thing worked fine in fact it looks practically new and acts like it. The point is keep your eyes open for used UPSes as they get surplusd out of the computer industry. Even if you have to spend more than I did to make sure you have a working unit. It still will be a fraction of the original price and often priced below the price of a new MSW inverter for the same power.

A UPS is designed to take variable amounts of input voltage (within a limit) and variable frequency and charge a bank of batteries, then it runs the load off the batteries, producing clean power in a continuous fashion. If the source power gets out of range or cuts off, it then switches to run off batteries totally until the source power comes back within range or the batteries get too low. For our use it doesn't care how the batteries get charged. If a windmill or hydo-power is changing the batteries directly, then the UPS will be happy to convert DC to 115 Volts 60 cycle AC as long as the battery voltage doesn't fall too low. If this happens it will start beeping and finally turn off. Through a serial cable the unit will also do a shut down on your PC before it runs out of battery. This is a complexity I don't plan on using. I do plan to add many more batteries in parallel. I think a MSW inverter or two would be good to have as backup. Keep your eyes open for used UPSes.

Offered by [Mike](#).

From much direct personal experience, it is usually the battery that goes dead in a UPS. The electronics most of the time are OK. The batteries are replaceable even though they are usually an odd size. Any store specializing in batteries can usually order replacements. Skip the manufacturer if possible. They will want to charge enough to put their kids through college for the price they want replacement batteries. Usually they just want to sell you another UPS. Most UPSes have either 6 or 12 volt batteries in them. Keep in mind, if you have *any* battery of the same voltage, it will work even if you have to keep the case open to connect it. Size is not important.

Offered by [Steve](#).



Troubled Times



Reel to Reel

These motors were taken out of old Mainframe 1/2 inch reel to reel tape drives. Typical each reel of tape had 2400 ft of tape. A lot of slow motion starting and stopping was done. Because of the relatively low price and ease of availability I decided to test a few of these motors to determine their workability as a generator for hand crank or bicycle generator use.



My current tests used a 1/3 hp 1725 RPM 115 Volt AC motor to turn the PM DC motor as a generator. A short section of garden hose with hose clamps were used as a flex shaft to couple both AC Motor and generator together. An oscilloscope, laser pointer, and solar cell was used to measure the RPM. Digital voltmeters were used to measure amperage and current. The motor was taped to a board using clear 2" wide tape.

For rough order power capabilities of a PM DC motor, do a resistance test. If one uses an Ohmmeter across the leads, the brush resistance will make it higher than it really is. The best way is to clamp the shaft so that it doesn't rotate and measure the current with some amount of voltage applied say 12-Volts DC. Using ohms law the resistance then is voltage divided by current. I now have 4 different types of these tape drive motors.

Ohms	Shaft	lbs.	Length	Volts	Amp	Vent	Color	Manufacturer
.677	1/2"	15	9"	60	1	yes	Black	Unknown (DC 54312)
.795	5/8"	11	7"	36	1	yes	Gray	Indiana General (4030D-95)
.839	1/2"	11	7"	50	1	no	Green	Ametek (E56617)
2.04	5/8"	9	6"	?	?	no	Black	Electro-Craft (E722)

Offered by [Mike](#).



Troubled Times



Voltage

The unit that gives the lowest resistance will give the most power. I choose the **Green Ametek** as typical and plotted electrical data on it.

**Typical Reel to Reel 1/2 inch Type Tape Drive
Permanent Magnet DC Motor or Generator
RPM Versus Voltage**

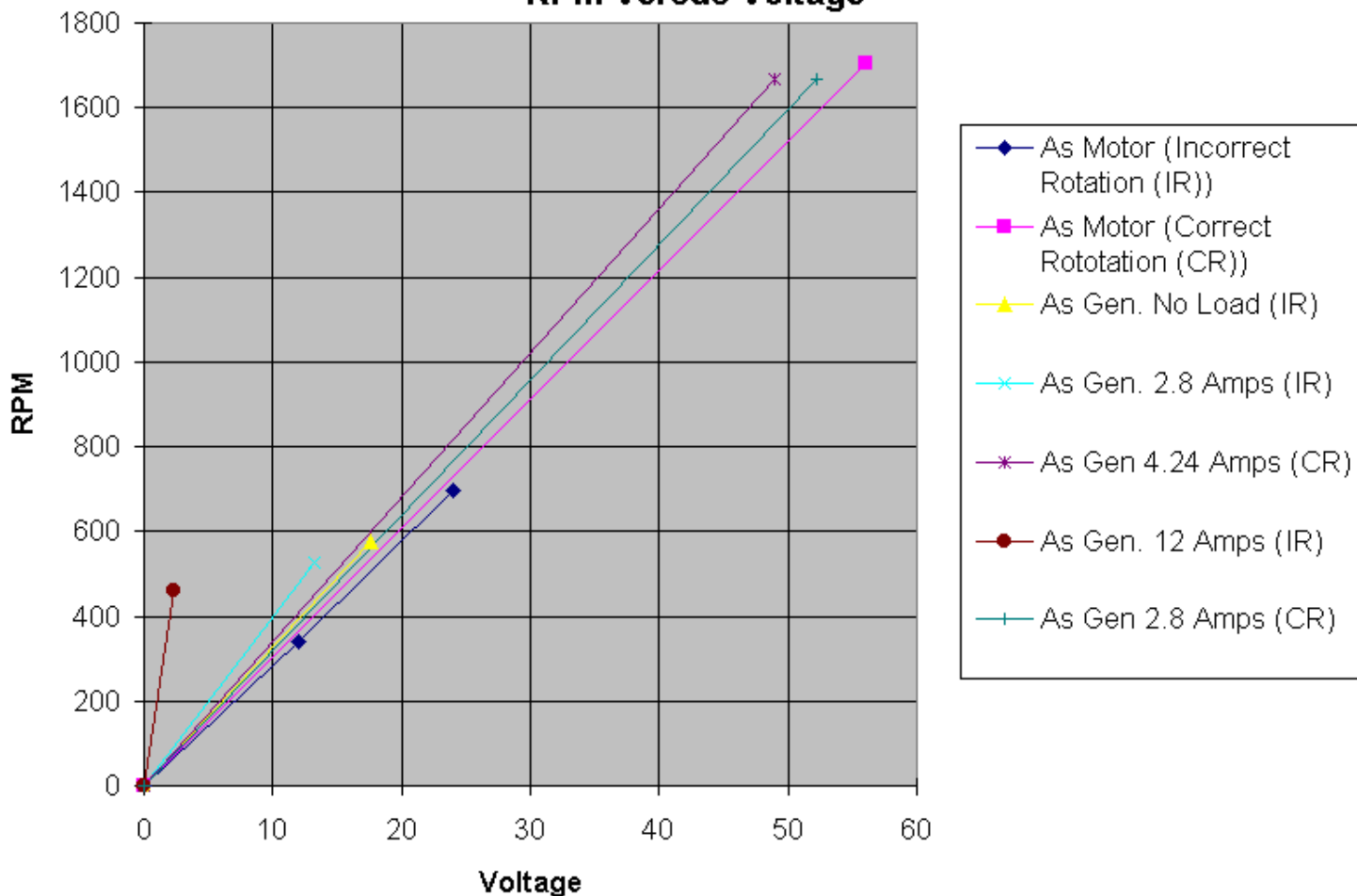

The above chart shows that as voltage increases the RPM increases. This chart compares running as a motor and running as a generator or running in reverse direction as motor and generator. The brushes are slightly offset for optimum power in one direction. As current generation increases the voltage goes down causing a new curve to be drawn.

Offered by [Mike](#).



Troubled Times



AMPS

Percent Usable Power Versus Amps
Total Watts Out Assuming 500 RPM as a constant
Approximate Speed needed to charge one 12 Volt Battery

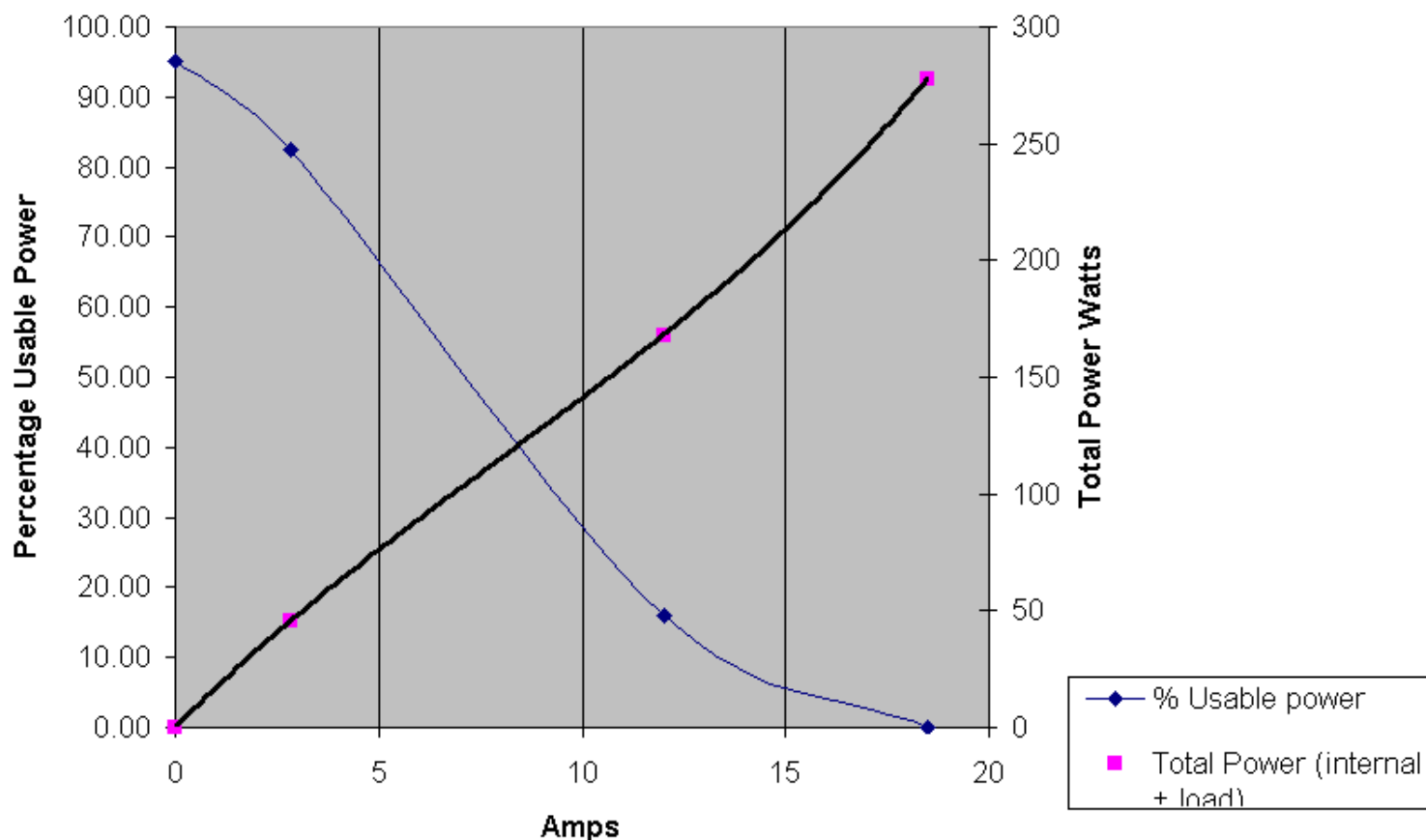

The above chart presents the relationship of percent usable power versus amps assuming we are running at about 500 RPM. This is the speed needed to optimally charge one 12-volt battery. Note that as the amperage goes up the percent usable power goes down. Also, note that as the amperage goes up the total power consumed goes up. Most of it is being wasted.

Offered by [Mike](#).



Troubled Times



RPMs

**Generated Power Versus RPM at 2.8 & 4.2 Amps
for Correct (CR) and Incorrect Rotations (IR)**

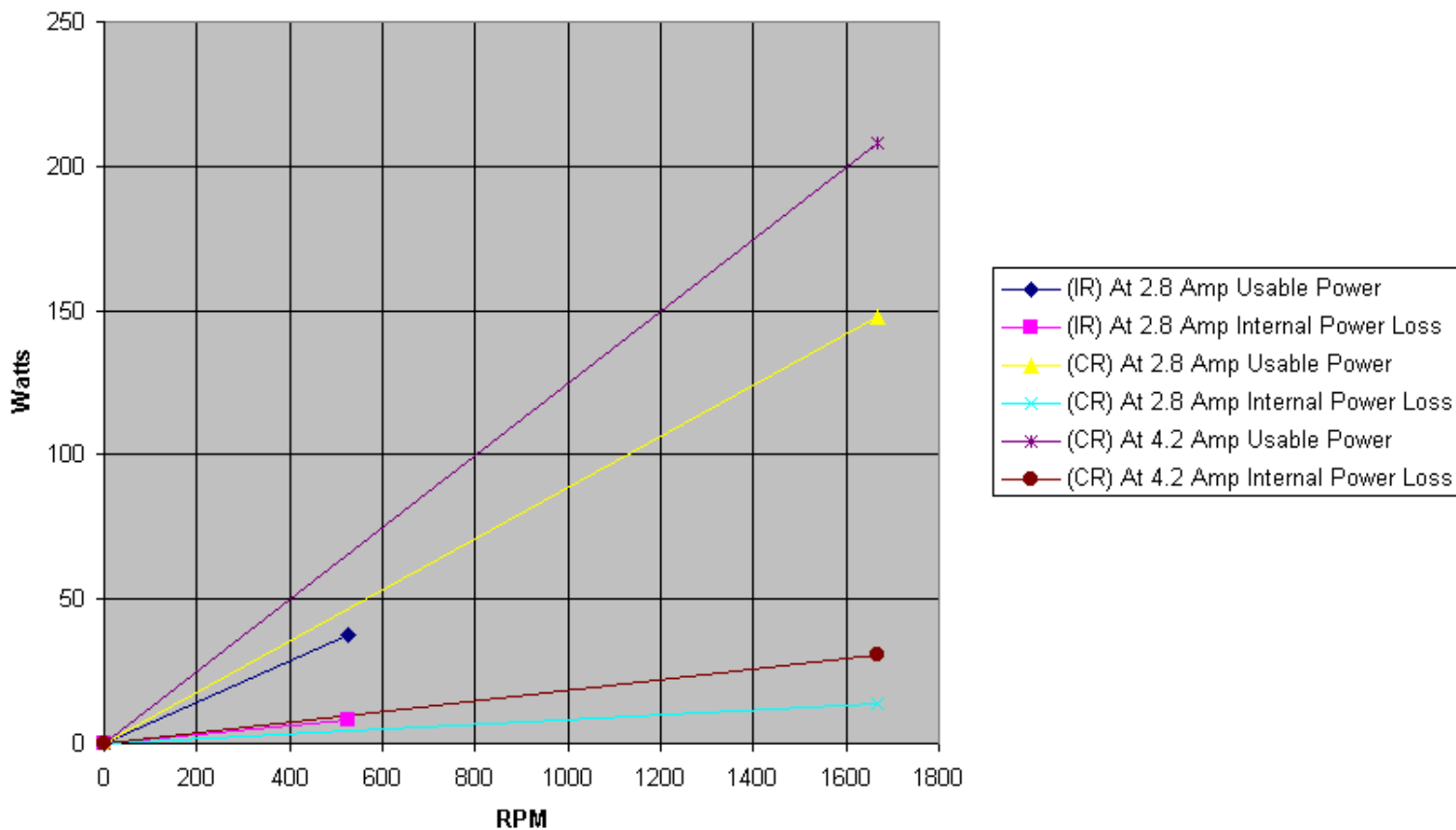

The above chart gives the generated power versus RPM for typical amperage produced. If a reverse polarity direction is chosen one can expect more power loss. Rotation in the opposite direction from what the motor was designed for causes brush noise (I found it harder to measure correct voltage with a digital meter) and more internal power loss. At higher amperage we have again more internal power loss and a new curve showing this. The usable power one can expect at about 500 RPM (charging one 12-Volt battery) is about 40-60 watts depending on the current (2.8 to 4.2 amps). The usable power at about 1800-RPM (to optimally charge at 48 volts or 4 batteries in series) is about 150-210 watts depending on the current (2.8 to 4.2 amps). This allows for charging at about 14 volts for each 12-volt battery.

After running continuously at an average of 3.6 amps for 42 minutes the 1/3 hp drive motor got hotter than the test DC motor-generator which measured 52 degrees Centigrade. The test motor-generator was sealed and had no forced airflow around the armature. It had to heat up the internal air and the air then would heat the aluminum and steel casing. If one were to drill holes in it for forced air cooling it could be used at a bit higher amps. Some of these units can be purchased with forced air cooling holes. See "Air Vent" column in the table above.

The lower the current used the longer the brushes will last. Assuming forced air-cooling, just a guess at this time, but I would

plan on running continuously at less than 4 amps. Under non-continuous operation one may be able to go to 8 amps occasionally.

Offered by [Mike](#).



Troubled Times



Low RPM

Some interesting results with mostly wood using low speed which is needed by windmills, from the [Other Power](#) company.

Our latest project. It exceeds the capability of our testing rig, so we don't have a maximum output figure yet - it does 500 watts pretty easily, and can probably do near 1000 watts. Quick and easy to build, though.

[Dan](#)

Offered by [Mike](#).



Troubled Times

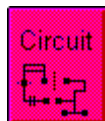

Chips vs Valves

Chips

from a "chip" or slice of rock (semi-conductor) used in its construction. Usually refers to silicon, germanium based solid state devices as in transistors, diode, integrated circuits. "Chips" and "solid state devices" are usually synonymous.

Valve

is another name for "vacuum tube" and is descriptive of the function that it does. Electricity is a flow of charged particles (usually electrons) and thus a fluid. A vacuum tube like a water valve controls the flow of electrons by rapidly partially "shutting off" and "turning on" the flow. How does it do this? If this were a water faucet (valve) you would turn the handle back and forth. In the case of a vacuum tube (or transistor) a small changing flow of electrons turns the handle back and forth (so to speak) and allows the main flow to be controlled. Internal control is not done by any mechanical handle means, but through ingenious use of the properties of charged particles. Like charged particles repel, and opposite charges attract. All you have to do is put a fence across the path of flow (called a grid) and charge it in such a way to repel the flow (shut it off) or attract the flow (turn it on). If you do all this in a vacuum then you have a vacuum tube.

Offered by [Mike](#).



Troubled Times

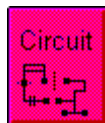

Transistors

If you move electricity through partially conducting rock or semi-conductors then you have a **transistor**. A transistor means literally "trans" across "resister" in other words it acts like a variable resistor. A small flow of electrons coming in from the side "base", controls the overall resistance or main flow between what's called the "emitter" and "collector". Frequency is just how fast you turn on and off the flow. These things are not magical they don't create electrons they just control the flow of existing electrons that are in the pipe or conductor already. "Amplification" just means a small flow controlling a larger flow.

To an extent think of electricity in terms of simple fluid flow of particles. Use the water analogy. Kink a water hose and you have resistance to flow or a resistor. Fill a bucket or reservoir and you have a charged battery. Put your thumb over the end of a water hose and hold back the pressure - this is analogous to **voltage**. High pressure of electrons trying to push through the wire is high voltage. Low pressure of electrons is low voltage.

Comparing the amount of water molecules coming out of a garden hose to fill a bucket, to that of a fire hose will give the idea of the term "amperage". Amperage is the amount of current flow and is a given large but finite number of electrons passing a given point in a conductor for each second. One ampere equals to 6,300,000,000,000,000 electrons/second passing a given point in a conductor. High **amperage** circuits need bigger pipes or conductors to carry the flow.

Make the **conductor** (tungsten) small and put about 1 amp of electrons through it at 110 volts of pressure and you have the filament of a 100 watt incandescent light bulb. The electrons are trying to get through that pipe (conductor) so fast bouncing into the molecules of the conductor that they cause more motion of the molecules thus it heats up. The molecules get so hot that they want to give off some of their energy. If our bodies got hot we would perspire and water evaporation given off would cool us. What molecules do when they get to hot is emit energy in the form a frequency of electromagnetic radiation. If high enough in frequency we can see it as light.

Offered by [Mike](#).



Troubled Times

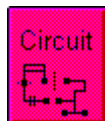

Electron Flow

For many of us it helps to put a personality to electrons. These little fellows don't like to get too close together. Being negatively charged they repel each other. They do like to keep in motion never stopping to rest. When these little fellows flow or move fast in a given direction they produce a **magnetic field** perpendicular radiating out from the direction of flow. Use the left-hand rule, thumb pointing in the direction of flow, curled fingers point in the direction of magnetic flow lines. Thus an **antenna** can transmit an electromagnetic energy flow just by having a bunch of these little fellows (electrons) running back and forth in a conductor. The transmitter circuit is then designed to cause this to happen by giving these little fellows energy and telling them how far to run back and forth (frequency).

EMP electromagnetic pulse is caused by a lot of **charged particles** moving in a given direction as occurs in lightning, nuclear explosions, etc. This causes a big magnetic pulse that radiates out and when it passes over something that is a conductor (has free electrons that can flow) gives some of it's energy to the electrons and causes them to flow. This can ultimately cause so much pressure at the end of the conductor that a **spark** can occur or damage can occur especially to sensitive circuits. Radios, TVs, communications equipment, etc. that have antenna and sensitive input circuits are especially susceptible to this type of damage.

Offered by [Mike](#).



Troubled Times

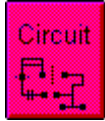

Amps

I have a 100 amp one wire alternator that only charges at around 2500 rpms. I have another one wire alt that is 65 amps, but the bearings failed prematurely, and as the bearings went, it seemed that it started only charging to 12.3 volts it never went more than that. And even before that happened it never charged over 12.7 volts, and this was a brand new alternator. Is there any way I can make one good alternator with these two? I would rather have a 100 amp. I have a '68 Camaro, but it has an aftermarket fuel injection system along with the electric fuel pump, and a/c. If you have any suggestions, they would be greatly appreciated. I took them both apart, but I am not sure what makes them 65 amps or 100 amps. How can I make the 100 amp alternator charge at a lower rpm? Thanks for any help.

The number of turns is related to voltage and speed. The higher the number of turns the slower it needs to turn to produce the same voltage. The bigger the wire in diameter the more amps it will carry. The problem with rewinding these to go at a slower speed and yet produce more amps is that the more turns and heavier wire are needed. I doubt it would fit the area allocated for it. The next issue is once the iron is saturated with flux it becomes difficult to drive an increasing magnetic field through a iron rotor and stator that is designed for the lower amps. The higher the amps the higher the field strength needed.

The most likely cause of the failure of the alternator in the first place is due to rectifier or diodes going bad or the brushes on the slip ring becoming weak or worn out or greasy. Another possibility is burnt windings. If this is the case you should be able to smell this if you get close. One could repair some or all of these possibilities however, the easiest thing to do is to use this as an old core and trade it in for a rebuilt. Request the 100 amps or the highest amps available for that year of car-engine.

Offered by [Mike](#).



Troubled Times

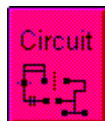

Alternators vs Generators

Generators contain permanent magnets whereas alternators require some amount of current to create electromagnets. You can get power by running straight from the generator/alternator; however the output voltage is dependent on it's speed of revolution. One thing that may be able to be salvaged from disabled/abandoned autos is their voltage regulators. They work in conjunction with the alternator to produce a constant output voltage that doesn't change as the engine speed changes.

Offered by [Ron](#).

The alternator is what converts the mechanical power to electricity. The alternator generates AC current. If you want to run an application directly from the generator instead of from the battery the output of the alternator needs to be rectified and filtered with diodes and capacitors (but this may be part of the battery charging circuit already) to produce DC.

Offered by [Michael S](#).

A common mistake that many make is to think that generators or alternators create electrons. This is not the case. Generators or alternators are like a water pump. You turn the shaft and the electrons present in the conductors are pumped along as these conductors are forced to cut across a magnetic field. The electro-magnetic pulse moves a magnetic field that causes electron flow. With a generator or alternator the conductor moves and the field is stationary or vice versa using the same principal as above.

Offered by [Mike](#).



Troubled Times

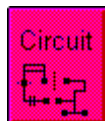

Wire Size

Wire sizes become important at low voltages. At 12 volts DC a loss of more than 10% in voltage across the length of the wire can mean the difference between the inverter running or not running. The currents can get high and any voltage drop becomes significant. In general at 12 Volts DC one should run the inverter close to the battery and then pipe the 120 Volts AC to the point of use on smaller wire.

The general rule is at low voltages pay attention to voltage drop and at high voltages pay attention to maximum current carrying capacity for the size of wire.

Properly sized wire can make the difference between inadequate and full charging of a battery system, between dim and bright lights, and between feeble and full performance of tools and appliances. Designers of low voltage power circuits are often unaware of the implications of voltage drop and wire size. In conventional home electrical systems (120/240 volts ac), wire is sized primarily for safe amperage carrying capacity (ampacity). The overriding concern is fire safety.

In low voltage systems (12, 24, 48VDC) the overriding concern is power loss. Wire must not be sized merely for the ampacity, because there is less tolerance for voltage drop (except for very short runs). For example, a 1V drop from 12V causes 10 times the power loss of 1V drop from 120V.

Use the charts on this [PDF file](#) as your primary tool in solving wire sizing problems.

Offered by [Mike](#).



Troubled Times

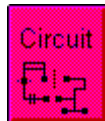

Universal Bracket

A unique bracket that mounts a GM alternator to a horizontal shaft gas motor. The simple way to build your own generator! Add a DC converter, and you have a super high output DC charging system, as well as an AC generator. We have designed and manufactured a simple, one piece universal mounting bracket specifically for this task! This bracket bolts to the motor (using a universal bolt pattern), and allows the alternator to bolt directly to the bracket. The bracket also has an integral belt adjustment slot which allows the alternator position to be adjusted, which serves to tension the belt.



Fits the following motors which is a 3 and 5/8th" bolt hole circle:

- **Briggs and Stratton 3, 3.5, 5 horse power.**
- Robin International 5 horse power.
- Tecumseh 5,6,7,8,10 horse power.
- Honda 5.5 horse power.

Offered by [Lou](#).



Troubled Times

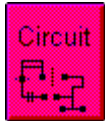

Load

From: [Selecting A Generator](#)

A generator must be properly sized for the load it will be used to handle. Electric motors are particularly difficult for a generator because starting an electric motor requires two to three times its nameplate amperage or wattage. While electricity supplied by an electric power company has essentially infinite surge capacity (limited only by the circuit protection provided), a generator is limited by the engine horsepower and inertia of rotating parts. A current surge of short duration can be supplied by a generator, but a current demand of longer duration, such as a heavily loaded motor starting a high inertia system, can overload a generator possibly damaging both the generator and motor. A 3450 RPM air compressor motor is a prime example of this type of load. For this reason, when determining the power your generator is to provide, it is important to calculate electric motor requirements at three times the running watts to compensate for the surge needed to start the motor. With this in mind, the following guidelines will be helpful in selecting the right size generator for your needs.

1. Total the wattages of all small appliances, tools and light bulbs to be operated at the same time. Most appliances have labels showing wattage (if volts and amps are given, volts x amps = wattage).
2. Next determine volt-amperes (wattage) requirement of electric motors to be operated, remembering that the starting requires two or three times the nameplate or running (rated) watts. Thus, if running watts of the motor is 600, multiply the number by 3 to determine maximum V.A. needed. The starting (max.) V.A. can also be determined by referring to the motor code listing which indicates starting KVA per horsepower.
3. Total watts and V.A. is Steps 1 and 2 to get total requirements.
4. To allow for anticipated future needs or use of extra equipment, add 25% to total load in Step 3.
5. See performance data charts at bottom of each generator listing for the unit that meets your total load criteria.

Equipment	Running Watts	Max VA
Light Bult (100 Watts)	100	100
Radio	150	150
Fan	200	600
Television	400	400
Refrigerator (conventional)	400	1,200
Furnace Fan (1/3 HP with Blower)	600	1,800
Vacumn Cleaner	600	1,800
Sump Pump (1/3 HP)	700	2,100
Refrigerator/Freezer Combination	800	2,400
6" Circular Saw	800	2,400
Floodlight	1,000	1,000
1/2" Drill	1,000	3,000
Toaster/Coffeemaker	1,200	1,200
14" Chain Saw	1,200	3,600
Water Well Pump (1/2 HP)	1,400	4,200

Hot Plate/Range (per burner)	1,500	1,500
10" Circular Saw	2,000	6,000
Water Heater (storage type)	5,000	5,000
Electric Oven	10,000	10,000



Troubled Times

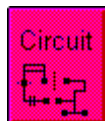

Features

From: [Selecting A Generator](#)

Common Portable Generator Features

Feature: Circuit breaker protected.

Benefit: Protects generator, tools and appliances from damaging overloads.

Feature: AC/DC simultaneous power.

Benefit: Run load and charge DC battery at the same time.

Feature: Panel mounted outlets.

Benefit: Allows easy access to receptacles.

Feature: Full capacity outlet.

Benefit: Capable of taking full load from one outlet.

Feature: Full protective cradle.

Benefit: Heavy-duty steel cradle protects engine and generator for safe and trouble-free transport.

Feature: Anti-vibration system.

Benefit: Generator runs smoother.

Feature: Battery charging.

Benefit: Convenient to charge batteries.

Feature: Spark arrest mufflers.

Benefit: Meets U.S.D.A. forest standards for safe operation in parks and campgrounds. Quiet operation.

Feature: Large gas tanks.

Benefit: Allows long periods of use without stopping to refuel.

Feature: Low oil shutdown.

Benefit: Prevents engine damage by shutting down engine if oil drops below safety level.

Feature: Idle control.

Benefit: Cuts engine RPM's in half when generator is not running a load. Reduces noise level and Gasoline consumption; extends engine life.

Feature: Electronic ignition.

Benefit: Eliminates troublesome breaker points and reduces maintenance.

Feature: Electric start.

Benefit: One touch on/off control.

Feature: Industrial/commercial engines.

Benefit: Tough cast-iron sleeve for longer life.

Feature: Wheel Kit.

Benefit: Assembly attaches to generator for easy transport.

Feature: Lifting eye.

Benefit: Provides strength and stability for lifting unit.

Words of Wisdom: In the nearly twenty years I have been selling generators, I have never seen anyone on their own purchase a generator correctly! Without exception, everyone wants to pay the least and get the most. This is one tool category where six months after the purchase is made the customer invariably wishes they would have bought a larger unit. The rule of thumb to become a happy generator owner is to spend it now, not later! Follow the Generator Selector Guide above and you'll be thankful.



Troubled Times

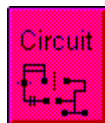

Semiconductors

Regarding valve (tube) based vs semiconductor based equipment.

1. Tubes, like light bulbs are fragile and burn out in a very short time under normal use relative to semiconductor devices.
2. Modern semiconductors used in transceiver service are much more tolerant of overload than just a few years ago.
3. Tubes are much more easily damaged by vibration and shock than are solid state devices.
4. If we are going to have computers or any of the other modern electronic devices, we will have to provide EMP protection for them anyway. Why not include modern solid state radio equipment in these protected enclosures?
5. There are solid state devices used in the sensitive front end stages of transceivers that can easily withstand nuclear EMP. They've been in military radios for 20 years.
6. If you really want a good transceiver that can withstand EMP and shock, buy a military transceiver; they aren't hard to find new from the manufacture or at surplus outlets.

No tubes for me, except for very high power amplifier transmitter applications; and I'll scrounge radio and TV stations to find um.

Offered by [Ron](#).



Troubled Times

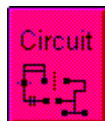

Valve-Based

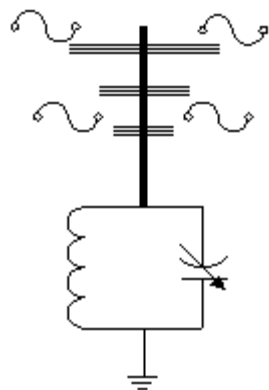

A violent pole shift there would also be violent electromagnetic storms and pulses, which we know as these are a well known components of nuclear explosions. It is known that these pulses destroy transistor based devices (i.e. chips in radios and computers) but not valve based devices. Electromagnetic pulses create surges that would overload and short out chips. Valves by comparison react very slowly to pulses and are much less likely to be affected if at all. A simple transmitter built from valves should be a must. I built a one valve 60 meter transmitter for about \$20 in 1986. It would not cost anymore today and virtually any one could build one. A frequency in the VHF range would be best. Being of a valve type will ensure it will survive serious electromagnetic spikes. These spikes would also affect computers, which certainly would have to be off line during that time to protect them.

Authored by [Darryl](#).



Troubled Times

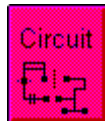

Magnets

I learned a while ago that one can make permanent magnets. Take a very big iron nail, take a hard rock or other hard surface. Place the nail with the point down on the hard surface, where the head points skywards. Take a big hammer and pound on the nail for a long time (1 hour+). The nail will be turned into a magnet. The hammering on the nail shakes up the magnetic alignment of the iron within the nail, where they re-align giving the bottom a negative load and the top a positive load (or perhaps it was the other way around, I can't remember). One question arises of course: Could one make an electric motor using a self-made magnet, with a copper coil around it?

Offered by [Michel](#).



Troubled Times

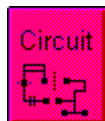

Induction Motor

Interesting data on how to get an induction motor that has been converted to an Induction generator started to generate power.

Offered by [Mike](#).

The loss of magnetism that his motor shows is classical and it is the true reason why the motor as a generator has to be started or turned off with the loads removed. Two hints that I have tried and seem to work.

- 1. Use a large amount of capacitance to get the generator to start and then switch out the extra capacitance (Leaving only the capacitance that is necessary to keep the generator going) once the generator is up to speed. Most motors have centrifical switches within them to do just that to the starting capacitor, when used as a motor.*
- 2. Putting a permanent magnet as near as possible to the windings. I think this works by causing a magnetic field to exist near the windings, then when the rotor disturbs the magnetic field, this induces voltage within the windings and the generator then takes off on its own. I've done this on one of my induction generators and it seems to help.*

Greg

Actually, if the induction motor come generator is connected to the power grid, no mods at all to the motor are required (the grid serves a similar function to the capacitors). If no wind is blowing or if the "generator" is turning slower than its synchronous rate however, it will act as a motor (not suprisingly). A switch is therefore required to disconnect the motor/gen until the wind is strong enough to spin it above the sync speed. One nice thing is that the system is self-synchronizing i.e. the gen automatically produces power at the same frequency and in sync with the power grid.

Laurie



Troubled Times

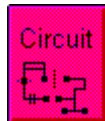

Wind or Water

I am thinking one could create one's own power grid by hooking a number of these type of units together, powered by wind and water.

Offered by [Mike](#).

I have done it for hydro turbines, which is easier. There is a very good book by Nigel Smith available from [Pico Trubine](#) which explains how to use induction motors for pelton turbines. It works well for me. I do not find that induction generators work quite so well when feeding rectifiers for some reason, so they have been disappointing for battery charging. But they do work and they are cheap. I have not used them for windpower because I do not like gearing up for speed, and because windpower varies so much.

Hugh

I agree that hydropower is a better fit for induction motors as AC generators.

Offered by [Mike](#).

Connect AC-capacitors between the phases and the motor (induction generator) acts like a generator. It starts generating at about half the rpm at which it is rated as a motor. The more capacity you add, the sooner it starts. You will discover that when operated as a wind turbine generator, you will have to reduce capacity as wind increases to get the most out of it. So, you either go for an average setting or make a controller that can switch between capacitors.

Claus, Denmark



Troubled Times

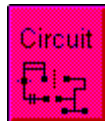

Scoraig

*Or go for the axial flux disk type PMG with no lams at all. [Scoraig](#), in Scotland. It's all there for free folks!
Paid for by the UK government.*

Hugh

Slow speed PMG generator building plans in PDF format. - 45 pages well illustrated.

Offered by [Mike](#).



Troubled Times



Gloomy



Graphic by [Michel](#).



Troubled Times



Requirements

After carefully evaluating how dark it is going to be - these are my thoughts. The amount of energy needed to generate sufficient light is beyond what the average survivor can conveniently generate. Any option that will require the use of any advanced mechanical devices is not acceptable. Let's look at a typical car alternator. I own a Honda that was built in 1986. I replaced my alternator last summer. Assuming that every car runs on average 3 hours a day, my car was running for 11 years. $11 \text{ years} \times 365 \text{ days} \times 3 \text{ hours} = 12,045 \text{ hours}$. If an alternator is used to generate light it has to be on for 24 hours a day which gives us $502 \text{ days} = 1,375 \text{ hours}$. Given advances in technology we can get 2 years out of each alternator. We are there for at least 25 years of gloom. In addition the amount of light needed per plant is quite high. At least 3 - 12 V lights have to be used per plant (never mind the light spectrum at this point). You will need at least 100 healthy plants per family. Minimum.

Offered by [Chris](#).

Its the diffused light that the plants use in the majority of their photosynthetic cycle. Plant leaves have more than three times as many stomas on the undersides than on the top. Although they do absorb light on the top surface of the leaf, they utilize the light they collect on the underside far more efficiently. (Stomas are gas exchange sites - the place where CO2 is taken up and O2 is released.) Think about greenhouses and how diffused the sunlight is once it passes through two panes of glass or plastic, yet greenhouse plants do so well, comparatively!

Offered by [Roger](#).



Troubled Times



Full Spectrum

From the difference between a *wide* Spectrum and a *full* Spectrum light?

It used to be that 'full spectrum' lighting meant lights which produced both ultraviolet B, ultraviolet A and the full visible spectrum as well infrared heat. Once incandescent manufacturers figured out that people were being told to look for 'full spectrum' lighting, they started to market their wide spectrum (producing some, but not all of the visible wavelengths and no ultraviolet wavelengths) lights with 'full spectrum' in the ads and on packaging. Thus people are buying Chromalux, NeoWhite and Reptile incandescent lights thought, incorrectly, that they are providing UVB, UVA and full visible wavelengths to their reptiles. In fact, incandescents are just producing, if they are putting out bright white light, only the visible spectrum; some which produce colored light, are not necessarily even producing the full visible spectrum, being corrected to increase or reduce certain parts of that spectrum.

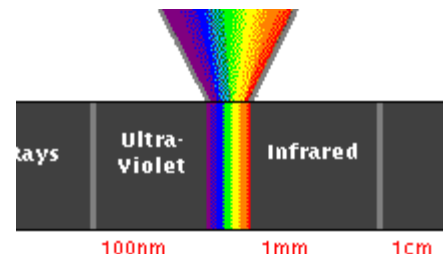

Fluorescent light manufacturers weren't slow to get on this bandwagon, either - unfortunately, not all fluorescents produce UVB wavelengths, either ...

From the Myth of Full Spectrum Lighting.

Q. When customers ask for "Full Spectrum Lighting," what should I tell them?

A. Tell your customer that there is no such thing. The myth about the healing powers of "Full Spectrum Lighting" simply refuses to die. It all began in the early 60s when a small lighting manufacturer devised a clever marketing gimmick. Claiming that its product featured "Full Spectrum Lighting," the manufacturer advertised that the lamp not only "brought sunlight indoors," but also cured a variety of ills ranging from Seasonal Affective Disorder (SAD) to a less-than-lusty sex life. This marketing campaign undoubtedly made a strong impression on many, especially the Federal Drug Administration (FDA) who issued a charge of health fraud in 1986. Knowing that there was no way they could support their claims, the manufacturer retracted the claims immediately. Although this happened ten years ago, many people, from holistic healers to ordinary shoppers, still believe in the healing powers of "Full Spectrum Lighting." Through very successful advertising without one iota of truth, the myth of "Full Spectrum Lighting" lives on.

FYI: All light sources cover the visible spectrum, they just peak at different points. Depending on the color temperature of a light source, measured in Kelvin or "K," a customer can choose a warm (3000K), a neutral (3500K) or a cool (4100K) color appearance depending on how he or she plans to use the lamp.

That myth is pure garbage. Lighting industry propaganda. Full Spectrum lighting is vastly superior for biological systems than ordinary lighting. Read Jonathan Ott's book: *Light, Radiation, and You* (1982/1990). Tons of research data and experiments that prove the point.

Offered by [Educate-Yourself](#).



Troubled Times



Blue Light

I note that Blue LED's are out because they are very costly. Problem is according to the summary published by NASA in conjunction with several universities is Blue is essential to plant growth. Recommendation from that study is from 1% to 20% blue LED depending on plant and growth requirements.

Offered by [John](#).

Please note that NASA used blue fluorescent lights as the supplementary blue light source. This is why I recommend the use of luminous tubes (neon lights). The luminous tube is the only routinely rebuildable light source I am aware of, and is long lasting at that (5 to 10 years). True a certain web of technologies must be maintained to support luminous tubes and you must be willing to deal with a modest amount of toxic mercury. I know of no other alternative for blue light. The luminous tube will also be able to supply needed ultraviolet light for disinfecting and vitamin D production.

Offered by [Steve](#)



Troubled Times



Health

Came across something on lighting. [Artificial Lighting](#) technology paper. When buying lights these are the numbers you should look for:

Kelvin rating of 5000 is considered a "daylight" bulb. Higher ratings take on a "bluish" glow - not bad for plants at all and not bothersome to people.

CRI - natural daylight has a rating of 100. The closer you get to 100, the better the simulation of daylight.

Keep in mind that plants need the red and blue spectrums to grow, but as someone who's been experimenting with this stuff for 3 years now, the blue and red just don't cut it by themselves for us humans. We need more than that to assist in the absorption of calcium, make workers work and children learn more efficiently.

Offered by [John](#).



Troubled Times



Photosynthesis

When one stops to think about volcanic dust in the atmosphere, one realizes that things could be very, very difficult.

Why Study Photosynthesis?

By [Devens Gust, Ph.D.](#), Professor of Chemistry and Biochemistry
Center for the Study of Early Events in Photosynthesis

One of the major energy-harvesting processes in plants involves using the energy of sunlight to convert carbon dioxide from the air into sugars, starches, and other high-energy carbohydrates. Oxygen is released in the process. Later, when the plant needs food, it draws upon the energy stored in these carbohydrates. We do the same. When we eat a plate of spaghetti, our bodies oxidize or "burn" the starch by allowing it to combine with oxygen from the air. This produces carbon dioxide, which we exhale, and the energy we need to survive. Thus, if there is no photosynthesis, there is no food. Indeed, one widely accepted theory explaining the extinction of the dinosaurs suggests that a comet, meteor, or volcano ejected so much material into the atmosphere that the amount of sunlight reaching the earth was severely reduced. This in turn caused the death of many plants and the creatures that depended upon them for energy.

Offered by [Glenn](#).

What frequencies of light are needed by plants. Since plants reflect back green light, then we know they don't need the green light frequency. Has there been any studies done to show what frequencies at what amplitudes produce maximum growth? Is it different for different plants? We will not have an over abundance of energy to spend to produce light. We will want to produce just the frequencies needed for maximum growth to save energy. Once these frequencies are found then what light bulbs produce these frequencies? Which of these bulbs are lowest cost, long lasting, and most durable to come through the various jolts of the pole shift? We have collected a lot of data on this subject but I do not believe we have a bottom line answer.

Offered by [Mike](#).

There is a very good paper on [Photosynthesis](#). This paper also includes a figure showing how different bandwidths of light are absorbed by different photosynthetic pigments, it is the same information one could find in a college biochemistry textbook.

Offered by [Steve](#)

Looks like it's blue and high-luminosity and superluminosity red based on the plant site and the led site. All I can say about all this is [Chromalux](#) light bulbs grow plants. I've done it with no other light source and my 5' high tomato plants in 6 weeks are testimony to its effectiveness. It's not nearly as efficient though as a Halide lamp.

Offered by [John](#).



Troubled Times



Planning

I would appreciate any information you could send me regarding this. I am in the middle of a small experiment regarding blue light, but the actual content of information available is minimal. Any information/results/sites you can relay to me would be very helpful.

Martin

I would be interested in how your experiment turns out - what you learn from it and what you are using for a blue light source. Aeorponics details light energy from various sources. The following web site shows a peak in the blue light spectrum at 430 NM for maximum growth. Note also the red peak at 680 NM.

<http://www.life.uiuc.edu/govindjee/paper/fig5.gif>

<http://www.life.uiuc.edu/govindjee/paper/gov.html#1000>

<http://www.life.uiuc.edu/govindjee/>

Offered by [Mike](#).

This source will help with the information on lights you need. They manufacture industrial lighting and I have seen charts they have that show how much blue and yellow needed for growth and the need for red area of spectrum for flowering and fruiting. I don't have their address, but their name is **Durotest Lighting Co.**

Offerd by [Woodie](#).



Troubled Times



Too Much

The following are selected quotes indicating what effects color of light (spectrum) and quantity of light have on plant growth.

[Spectrum](#) and plant growth

Terrestrial plants are extremely sensitive to the red/far-red ratio (called the zeta ratio). Changes in the zeta ratio can completely alter the structure and growth of plants. Aquatic plants, however, are likely far less sensitive to the zeta ratio because of the rapid and variable attenuation of light in fresh waters.

[Darkness](#) period and plant flowering

The distinction between describing a plant as a short day plant or a long night plant is not important as long as the plant is on a 24 hour cycle. If it gets short days, it will automatically get long nights. The distinction was made because it was found that plants measure the night length, not the day length. There is a pigment in plants called phytochrome that exists in two forms, phytochrome red (P660) and phytochrome far red (P700). Plants begin their nights with most of the pigment in the P700 form, which slowly converts to P660 during the night. The amount converted is the measure of the night length.

P660 absorbs red light, with a peak absorbance at a wavelength of 660 micrometers. When P660 absorbs red light, it converts to P700. P700 absorbs far red light, with a peak absorbance at 700 micrometers. When P700 absorbs far red light, it converts back to P660. Daylight has a lot more red light than far red light, and that is why the plant starts off its night with mostly P700, the form that slowly reverts to P660. A short day (long night) plant needs a long night to accumulate enough P660 to trigger the hormonal sequence that leads to blooming. If the night is too short, P660 does not build up to high enough levels to trigger blooming. The two phytochromes are quite sensitive to light, and even room lighting has enough red light to keep the "clock" from running, i.e., keep any P660 from building up. Even the relatively dim light from street lights has enough red light to slow down the clock and give plants the "misinformation" that the night is a lot shorter than it really is. Every November I see weeds growing near street lights that delayed blooming and got killed by the frosts while still in the vegetative state. Further away from the lights, the weeds have gone to seed in plenty of time.

Steve Pushiak mentioned on Jan. 22 that his Ocelot sword bloomed after he had been on vacation for a week. While the house was unoccupied, there were no room lights on after dark to prevent the clock from running, and the plant got the long nights required for blooming. Room light strong enough to keep the clock from running is not strong enough for any meaningful photosynthesis.

"Normal" light that plants are likely to encounter has much more red than far red light, and so the effect is always to reset the clock to the point where nearly all the phytochrome is in the P700 form. With just a brief flash of red light in the middle of a long night, the clock will be reset, and the plant starts counting from the beginning. With a special filter that only allows far red light through, it is possible, with a flash of far red light, to run the clock to the end and create the effect of a long night.

Offered by [Mike](#).



Troubled Times



Wrong Spectrum

The following are selected quotes indicating what effects color of light (spectrum) and quantity of light have on plant growth. Paul Krombholz states:

[Light](#) intensity, spectrum:

I did say that blue light promotes shorter, bushier growth, while red light promotes taller, lankier growth. This wasn't an original statement on my part though, it's pretty well documented in horticultural literature. I didn't say anything about leaf size. The trouble is that people have taken the above statement to mean that you can (should?) emphasize one end of the spectrum over the other. What I was trying to get across (and obviously failed, since this has come up numerous times) is that with our present knowledge or lack thereof, it would seem prudent to provide good balanced coverage at both ends of the spectrum.

As far as long internodes and small leaves, in my experience, this is most likely a sign of inadequate intensity, rather than the "wrong" spectrum, what ever that is.

Offered by [Mike](#).



Troubled Times



Intensity

The following are selected quotes indicating what effects color of light (spectrum) and quantity of light have on plant growth. Karen Randall - **Aquatic Gardeners Association** states:

[Fluorescent Bulbs](#) used for aquatic plant growth

Light requirement is sometimes expressed by the fairly awful measure watts per gallon. At less than 1 watt per gallon you are restricted to only a few kinds of plants with low light requirements. 2 watts per gallon will grow most common plants. For plants with high light requirements or really heavy planting where the plants seriously shade each other, you should have 3-4 watts per gallon.

The whole business of lighting and planted tanks is very much a 90/10 thing - you can get 90% of the results with 10% of the time/money/trouble, and the other 10% requires the other 90%. So don't be afraid to start out with a simple and cheap set up and only upgrade if you can't get satisfactory results.

Offered by [Mike](#).



Troubled Times



Gardening

[Arabidopsis](#) is a very efficient lighting system for indoor plant propagation. It also uses a wicking system for irrigation. If we could come up with something similar at a lower cost, it holds great promise.

Offered by [Toni](#).

Regular fluorescent grow lights are very good for starting seeds out. They burn relatively cool so you can put the plant very close to the light. They often brag about their spectral output resembling the suns. But when it comes to actual growing for vegetable production they simply don't have enough lumens (brightness). If you choose fluorescent, and they are a good choice, go for the higher output bulbs, meaning very high output (VHO) or at least high output (HO). They will require a different ballast, and if you want to boost performance and bulb life go with an electronic ballast. Compact fluorescents are also good, having a higher output than standard flo. bulbs. If you really want to grow plants go with metal halide or the high pressure sodium bulbs. In my experience, lumens are overall more important for growth than having a balanced spectrum. You can easily grow sun loving plants like tomatoes and peppers indoors using them. Plants can often absorb light at many wavelengths, and algae is especially good. Please don't overlook algae!

Offered by [Stan](#).



Troubled Times



Hours/Day

We need someone who can tell us really about how much vegetation is needed per person/day and thus area to be lighted, and how bright, so we can come up with a realistic target.

Offered by [Ron](#).

True, there are some plants that do better with more or less, but overall, 10 hours is just fine. Another thing, plants are very adaptable. They will adjust to whatever light conditions are available. This may result in reduced yields, reduced foliage, etc. We have some time left to experiment with different periods of light, but not much. For the most of us, planning on a 10 hour rotation should be sufficient.

Offered by [Roger](#).

For most plants, 16 hours a day is the time needed to run light. Several plants need darkness for a period of time as well. The only way to do this would be to have enclosed areas that don't allow the light generated to escape from the 3/4 area you suggest. Then you have significant ventilation issues which are very important to plant growth. Rolling the lights along for increased productivity is definitely something that should be planned in your indoor plant development. There are also plants that only require 12 hours of sunlight (but this reduces your yield). There is no free lunch here. I would suggest *three* rooms with *two* sets of lights. That way you get the 16-hour days that maximize plant growth as we know it today, which is really all we can prepare for.

Offered by [John](#).

I recommend decreasing the coverage area by 12/16 or 3/4. The plants will now get the same amount of light in 12 hr instead of 16 hr. This will allow one to run for 12 hr and shut off or shift the lights to another room that was dark for 12 hr. One then generates electricity at a constant rate for 24 hr/day. Thus, 1.5 more growth for any given generator size. If costly LED arrays are used the same unit each 12 hr could be shifted on overhead rollers between two adjacent rooms. Some innovation would be needed.

What I am thinking of is two big open rooms with light fixtures spaced on one big grid. One light area (node on the grid) would bleed off into the next light area (next node on the grid). The spacing would be appropriate for maximum growth for the planned time the lights were on. The proper spacing you would need to come up with from your experience. The lights would then be shifted from one room to the next by way of overhead rails with pulleys assisting the motion. Would take some thought to make this simple. Around the edges of this grid where the light tapers off - plant items that will still grow with low light.

If I remember correctly the algae *Chlorella* only likes to be in the sun for about one minute. Then it needs darkness for about a minute. This is why it is constantly stirred. There could be some other plants that like it just fine with 5 hr of light and 5 hr of darkness. Once we are no longer using the sun for light, there is nothing magical about 24 hr. I will bet a lot of the plants that we find on this planet were not native to this planet. I suspect many came from other worlds. These might work best with a different cycle of light and dark. One could say even if this were true, by now, they have been here for so long that they surely would have adapted to the 24 hr day. This is a valid point and should be our starting point for many.

I would like to see a study on this for I will bet one can get more volume of growth for many plants if one shortens down to say 10 hr light and 10 hr dark time. This could be done over a gradient of a few generations of plants getting

shorter each time. I will bet someone has done a study on this. In some cases it may turn out 16 hr of light and 16 hr of dark is optimum. Or say 16 hr of light and 5 hr of dark. Then our task is to find something that likes 5 hr of light and 16 hr of dark to grow in the other room. You get the idea many things are possible until we find the optimum solution.

Offered by [Mike](#).



Troubled Times



Reflectors

Has anyone experimented with reflectors? If we're using the dome architecture for our indoor gardening/hydroponics, we can line the interior of the dome with a reflector like aluminized mylar (or aluminum foil if mylar does not prove to be affordable) and use fewer lights. The hyperbolic nature of the dome interior will serve to focus and direct the light onto the plants.

Offered by [Roger](#).

I've recently read an article in a newspaper about a new kind of plastic-like foil, called Mylar. This foil is supposed to be capable of reflecting light by 99%. They say that if you would use this as a mirror, you'll be able to see yourself about 29% sharper than with a conventional mirror. Some company called **3M** has developed this and is going to bring this on the market somewhere next year. I'll certainly look out for this.

Offered by [Jeroen](#).

Rolls of Mylar are expensive, get trashed quickly, and actually return less light than does flat white latex paint. While not intuitively logical, this has been measured inductively by selective growers; flat (*not* glossy) white paint returns 98% + of the light it catches. The mylar does not stay perfectly smooth, and tends to refract light in too many directions. Silver-backed mirrors, on the other hand, have a hard surface and can be better controlled for reflective shape (which should be parabolic). The mirror or white paint will return the light for you; the curve will concentrate and intensify it.

The best measure of how effective a given shape of reflector is, is the intensity of candle power per square foot that it produces. High light plants (anything which needs to flower and fruit) do best getting at least 50 lumen per square foot. There are meters which can be purchased which will measure your actual luminosity - no need to guess. Go to a nearby hydroponics store for one, or look up hydroponics sources on the Web. With a flexible, flat mirror, you can keep adjusting the curve of the parabolic surface and measuring your actual results to find where you produce the greatest intensity of reflected light.

Offered by [Jenny](#).

Mylar around a room does increase the light on the peripheral plants and it works to some degree (certainly cheaper than a bulb as an example) and that was how the snaplite got from 4 sq. ft. to 9 sq. ft. The **3M** website sounds extremely interesting and **3M** knows what it is doing! It does look like this product *diffuses* light instead of focusing it in the examples **3M** cites. Plants need focused light. It's entirely possible this product can do that as well.

Offered by [John](#).



Troubled Times



Space/Person

You're going to need 144 sq. ft. to feed a person for a year. There are some books that talk of 100 sq. ft. but I personally believe that to be an ideal in terms of crop yield and variety, and I would rather be on the safe side. Therefore, just for 1 person, you need 2000w of electricity if using halide, or 720 watts if using LED's (16 snaplite devices). A halide lamp without outside light covers 64 sq. ft. A snaplite covers 9 sq. ft.

Offered by [John](#).

So, if I calculate correctly, that would be (for a community of 30) using:

halide $2000 \times 30 = 60\text{KW}$ generation; or using

LED's $720 \times 30 = 21.6\text{KW}$ and

$144 \times 30 = 4320$ sq. ft. growing area.

Plus additional area to move around in to care for and harvest the plants.

Offered by [Ron](#).

There is not a whole lot of difference in 100 vs. 144 sq. feet if you're talking about row cropping. If you're considering raised bed techniques and inter planting, then there is a lot of difference between 100 and 144 sq. feet.

Offered by [Roger](#).



Troubled Times



Efficiency

The luminous tube is capable of producing UV as well as other wavelengths of light and is rebuildable. It is the only routinely rebuildable light source I am aware of. Typically a tube can last 5 to 8 years. If you are prepared with the right skills and means you can reuse materials in the lamp indefinitely. This can not be said of other light sources with the exception of carbon arc lamps, but by comparison carbon arcs are probably more resource intensive, less efficient (about 4.6% total efficiency) require high currents to operate and produce CO₂ gas from the consumption of the electrodes. Just try to keep one burning 24 hours a day and see how much time you spend making electrodes and keeping the feed mechanism working. But yes, carbon arcs produce UV light.

You could try to keep a bunch of automobile headlamps working, but there again you are depending on a consumable item for your life support. You would have to be producing high current DC to keep a garden growing to keep a handful of people alive, if you are not running your lamps will give you the most useable life if they are kept burning at a steady current. Thermal cycling is death to incandescent lamps. The more you turn them off and on the fewer burning hours you get out of them. You could keep them burning and provide day/night cycles to your plants by moving the lights to different plants. There is a basic tenet of thermodynamics that says heat causes failure (I paraphrase). A light source that produces a lot of heat because of inefficiency will also experience a short life as a result of that heat. Heat is not only produced in the lamps, but in the power systems feeding the lamps because of the high current being used.

You would be better off with a lower current, higher voltage power source. It would require less infrastructure for the power produced, and will last longer with fewer problems because it is not subjected to so much heating. If you also use more efficient light sources that last longer you are left with a power and lighting system that will give you *ten times* the benefit for each Watt produced than the inefficient, low voltage, high current approach.

Offered by [Steve](#)



Troubled Times



Maximum Efficiency

Brightness Values: Magnavox Electronics Reference

Light Source	Lux	Watts/ft2	Watts/m2
Office fluorescent Lighting	300-500	.04-.07	44-.73
Halogen lamp	750	.102	1.10
Sunlight, 1 hour before sunset	1000	.136	1.47
Daylight, Cloudy sky	5000	.680	7.35
Daylight, Clear sky	10,000	1.36	14.7
Bright Sunlight	> 20,000	2.72	29.4

Note that the above watts/sq. ft and watts/sq. meter is the amount of energy in the light and not the amount of watts that it took to make the light. Many light bulbs are inefficient. Typically only 10% of the energy goes to make light in vacuum tungsten filament light or possibly up to 20% with halogen bulbs. Florescent are about 70-90% efficient. I pulled the following quote from [Lite Manufacturing](#):

Under natural conditions, maximum rates of Photosynthesis are attained in single leaves of many species at 25-35% of full sunlight intensity and in some shade species at even lower intensities.

If one now takes 25-35% of 14.7-29.4 watts/sq. meter one gets 3.7 to 10.3 watts/sq. meter or an average of 7 Watts/sq. meter. Note that this is very close to 6 watts/sq. meter. Now lets start from scratch and calculate an estimate amount of light hitting your plants. From *Handbook of Engineering Fundamentals* by Eshbach second edition. Efficiency of light sources table 4 page 10-33.

Light source efficiency	(lumens/watt)
tungsten gas filled	20
tungsten vacuum lamp	10
Fluorescent: (includes ballast loss)	
standard cool white	46.5
standard warm white	51.2
de luxe cool white	29.0
de luxe warm white	31.0
daylight	41.3

Depending on the bulb used you could be putting out

29lumens/watt*40watts = **1160 lumens** or
 51.2*40= **2048 lumens** of light

Offered by [Mike](#).



Troubled Times



Watts/Plant

One way to estimate how much reflected light your plants are actually getting: 4 ft fluorescent tubes radiate light cylindrically mostly. Thus one can determine a cylinder of a diameter (average distance to center of the plant) and about 5-6 ft long, assuming your plant is not too far away. Determine the surface area of this cylinder and the percentage of the area used by the plants at this distance. This equates to the same % as the wattage from original bulb. Subtract about 10-20% from the wattage of the bulb due to inefficiency of conversion from electricity to light. There will be some reflection from the back reflector on the light. Assume this to add approximately 50% to 100% more light on the plant area. Take into account the multiple fluorescent tubes you have in close proximity.

The result is an estimate of the number of watts actually hitting the plant which can then be divided by the area of light the plant actually uses to get the watts/area.

Offered by [Mike](#).



Troubled Times



Metal Halide

Here is how the following recommendation was arrived at by [Lite Manufacturing](#) for metal halide 1000 watt lights.

Q: How much Light [for growing plants] do I need?

A: 20-40 watts per sq. ft. is a general guideline. The more efficient the Light source, the less watts per sq. ft. needed. For example using 1-1000 watt metal halide light, in a 50 sq. ft. area would give you 20 watts per sq. ft. and a total of 120,000 lumens.

Solving the equation given in the following link for "CU" or the coefficient of utilization of light, we get: $Cu = (E * S * W) / (L * LLF) = (4760 \text{Lux} * 50 \text{sq.ft.} * .0929 \text{sq.meter/sq.ft}) / (120,000 \text{lumens} * .8) = .23$ or 23% efficient. In other words we need at least 23% efficient reflector to direct the light to this 50 sq. ft. area to get our minimum 4760 Lux amount of light to grow plants for 12 hrs/day.

Now what about the electrical efficiency of the 1000 watts converted to 120,000 lumens. Recall that: One Lumen (at 5,550 Angstroms) = .00147 Watts. Actual light energy in wattage = $120,000 \text{lumen} * .00147 \text{watts} / \text{lumen} = 176$ watt of light from a 1000 watts consumed. The difference is emitted as heat. Thus the electrical Light efficiency = $176 \text{watt} / 1000 \text{watt} = .176$ or 17.6% efficiency.

Summary: This setup converts 17.6% of it's energy to light of which 23% will need to fall within the 50 Sq. ft. to make plants grow.

Offered by [Mike](#).



Troubled Times



Street Lamps

According to a study on the *Environmental Effects of Roadway Lighting* street lamps are designed to direct a high percentage of their light toward the street (45%). Lets assume your lamps are less efficient say 30-40% of the light generated falls within the .39 area of useable space. Lets assume we can keep the bulbs clean and that aging is the only factor of say about (.8). Illuminance of 4 (40 watt florescent tubes) = $(L * CU * LLF) / (S * W) = [4 * (1160 \text{ to } 2048 \text{ lumens}) * (.3 \text{ to } .4) * .8] / (.39 \text{ sq. meters}) = 2855 \text{ Lux to } 6721 \text{ Lux. (Or an average of } 4788 \text{ Lux).}$

What should we expect to need? $(7 \text{ watt}) * (680 \text{ Lux/watt per Sq. meter}) = 4760 \text{ Lux}$ would be the minimum from above. Steve said tomatoes grow best at 4000 Lux, 18 hours a day. If the hours decrease to 12 hours that's a 22% decrease in time and now if we add 22% to 4000 Lux we get 4880 Lux. Very close to the same result.

Bottom line: Depending on the bulb you are using and the actual efficiency of light delivered to the useable area of .39 sq. meters, you both are talking about the same order of magnitude of light.

Offered by [Mike](#).



Troubled Times



Reference Material

With the accumulation of crop production data from universities and NASA centers, a need arose to compile the findings into a database. Such a database was initiated in 1997 by Frank Salisbury and Mary Ann Clark at Utah State University by canvassing past and present *ALS* investigators (see *Salisbury and Clark, 1996*). Survey questionnaires requested inputs on crop yields, growing techniques, environmental requirements, and nutritional analysis. Maintenance and upkeep of the database will be an ongoing effort and serve as a resource for generating crop production protocols, or "handbooks" for BIO-Plex and future *ALS* projects.

7. Knight, S.L. and C.A. Mitchell. 1988

Growth and yield characteristics of 'Waldmann's Green' leaf lettuce under different photon fluxes from metal halide or incandescent + fluorescent radiation. *Scient. Hort.* 35:51-61.

19. Wheeler, R.M., C.L. Mackowiak, and J.C. Sager. 1991

Soybean stem growth under high-pressure sodium with supplemental blue lighting. *Agron. J.* 83:903-906.

21. Yorio, N.C., C.L. Mackowiak, R.M. Wheeler, and J.C. Sager. 1994

Vegetative growth of potato under high-pressure sodium, high-pressure sodium SON-AGRO, and metal halide lamps. *HortScience* 30:374-376.

Other reference material also exists:

Biomass Production Chamber (BPC)

The BPC uses ... 400 W high pressure sodium lamps, each requiring a separate ballast. Each plant growing shelf in the BPC is covered by ... 3 lamps per canopy. ... with the lighting intensity in each section being variable between 200 and 1200 $\mu\text{mol}/\text{m}^2/\text{s}$.

Horticultural Requirements

Temperature requirement is the one parameter that can not be overlooked. Warm temperature crops (26/22 $^{\circ}\text{C}$) could be grown cooler by sacrificing some yield but growing cooler crops under warm conditions can lead to little or no edible biomass for a variety of reasons, e.g., excessive vegetative growth, bolting, and infertility.

In the dark, both humans and plants respire, giving off CO_2 . For a given day, enough O_2 must be produced by the crop canopy during the light cycle of a photoperiod to support the human requirements. ... This equates to the O_2 requirement of nearly 1 person for the 20 m^2 of growing area in the BPC. A growing area of 25 m^2 would provide the air revitalization for one human.

Offered by [Mike](#).



Troubled Times



Lux Meters

To minimize calculations and guessing and to maximize reflected light to our plants, we will need a light intensity (Lux or foot-candle) meter of one type or another. We will ultimately need a table of minimum to optimum Lux for a given hours per day for each class of plants we intend to grow. To balance the red and blue intensity, some of us will need to measure to an extent color, chromaticity, or Kelvin temperature. Where to buy a Lux Meter? The following are some of the alternatives.

[LX-101](#) \$65.95

[LX-02](#) \$39.00

[Extech Model 401025](#) \$119

I know that a light intensity or Lux meter can be built out of a simple solar cell and a digital current meter for less than \$20. The question is if one did this without a reference meter as a standard, how does one calibrate it? All I can think of right now is a candle one foot away for the low end and the sun for the high end. Aside from there being no sun after the pole shift, neither is a good stable, non-variable source. Building a color or Kelvin meter is another story. Possibly using the same Lux meter with some color filters would serve our purpose.

Offered by [Mike](#).



Troubled Times



Light Bulbs

From: *How Things Work*

By: **Louis A. Bloomfield**, Professor of Physics, The University of Virginia

Electric discharge lamps are between 2 and 5 times as energy efficient as normal incandescent light bulbs. The hot filament of an incandescent lamp delivers only about 10% of its electric power as visible light. In contrast, a fluorescent lamp delivers about 25% of its electric power as visible light and some gas discharge lamps (particularly low-pressure sodium vapor) deliver as much as 50% of their electric powers as visible light.

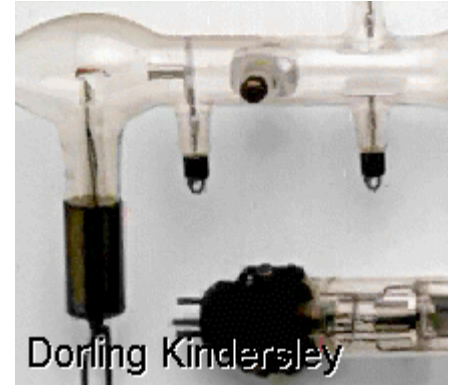

Q: How much life is consumed each time you turn on a fluorescent lamp?

The starting process erodes the electrodes of a fluorescent tube through a phenomenon called sputtering. A typical fluorescent tube will last about 50,000 hours if left on continuously but only 20,000 hours if it's turn on for just 3 hours at a time. From that tidbit, I think its fair to say that a fluorescent tube can only start about 10,000 times. If the tube costs \$5, you are spending about 0.005 cents per start. If the electricity to operate that tube costs about 0.2 cents per hour, then turning the tube off for about 1.5 minutes saves the same amount of money in electricity as it costs in tube life when you turn the tube back on. In short, if you turn the lamp off for less than about 1 minute, you're wasting money. But if you turn it off for more than 10 minutes, you're saving money. In between, it's not so clear. There is a myth that turning on a fluorescent lamp consumes a huge amount of electricity so that you shouldn't turn the lamp off and on. There is simply no basis to that myth.

Q: What are the different types of light bulbs and how do they work?

An incandescent light bulb works by heating a solid filament so hot that the filament's thermal radiation spectrum includes large amounts of visible light. A fluorescent tube uses an electric discharge in mercury vapor to produce ultraviolet light, which is then transformed into visible light by fluorescent phosphors on the inner surface of the tube. A gas discharge lamp uses an electric discharge in a gas inside that lamp (often high pressure mercury, or sodium vapor, or even neon) to produce visible light directly.

Q: What is the composition of the phosphors used in fluorescent light bulbs?

The exact composition depends on the color type of the bulb, with the most common color types being cool white, warm white, deluxe cool white, and deluxe warm white. In each case, the phosphors are a mixture of crystals that may include: calcium halophosphate, calcium silicate, strontium magnesium phosphate, calcium strontium phosphate, and magnesium fluorogermanate. These crystals contain impurities that allow them to fluoresce visible light. These impurities include: antimony, manganese, tin, and lead.

Q: Do regular fluorescent lights emit ultraviolet light? If so, how does the ultraviolet level compare to what we would receive if we were outside?

While the electric discharge in the tube's mercury vapor emits large amounts of short wavelength ultraviolet light, virtually all of this ultraviolet light is absorbed by the tube's internal phosphor coating and glass envelope. As a result, a fluorescent lamp emits relatively little ultraviolet light. I think that the ultraviolet light level under fluorescent lighting is far less than that of outdoor sunlight.



Troubled Times



Halogen Quartz Lamp

Halogen and Hybrid Fluoro lamps are breakable, but these small lamps are not built like the large suspended elements found in 240 volt lamps in Australia or 110 volt lamps in the US, which you only have to shake a bit and the filaments break. These quartz lamps are the same as the ones fitted into car and truck headlights, the very ones that can go for a rough ride in a four wheel drive vehicle over a corrugated dirt road and still work fine. My guess is that the rock and roll from large earthquakes would have *no* adverse effects, because these quartz lamps are well proven in road vehicles. Hybrid Fluoro lamps are so tough they need to be physically crushed to put them out of service. In any case, all the more reason to build a bungee rack for fragile gear and store extra spare bulbs in advance.

These lamps are all 12 volt quartz Halogen, using low watts, but because of the nature of low voltage, the low watt quartz Halogen light in lumens is quite significant and may be the answer to lighting in the aftertime!

Authored by [Darryl](#).



Troubled Times



Bulbs and Filters

The following tables are based on tables by lighting specialist William H. Gehrman, in *Evaluation of Artificial Lighting* (in *Reptile Medicine and Surgery*, 1996, edited by Douglas Mader DVM):



Representative Light Sources and their Principal Types of Radiation Source

Sun

UVB 290-320 nm, UVA 320-400 nm, Visible 400-700 nm, Infrared 700 nm

Incandescents (frosted, reflector floods, spots, halogen lamps)

UVA 320-400 nm (low levels), Visible 400-700 nm, Infrared 700 nm

Fluorescents: Chroma 50, Colortone 50, Design50, Cool White, Warm White

Visible 400-700 nm UVB 280-320 nm (low levels), UVA 320-400 nm (low levels), Visible 400-700 nm

Plant Lights

Emphasize red and blue spectrums within Visible 400-700 nm

Blacklights (BL)

UVB 290-320 nm (low levels similar to Vitalites), UVA 320-400 nm

Blacklight Blue (BLB Same as BL but with less blue light emitted)

Reported harmful to eyes

Sun lamps

High levels of UVB causes skin cancer, cataracts, etc.

High Intensity Discharge Mercury, Metal Halide

Visible 400-700 nm, Infrared 700 nm; UVA and UVB are shielded due to extensive damage to skin and eyes caused by such high intensity

Transmission of UV Radiation through Various Materials

Window glass	single thick	785
Acrylite GP acrylic	0.635 cm	60
Acrylite OP-4 acrylic	.318 cm	8979
UV-T Plexiglas	.635 cm	8964
Cellulose triacetate		6730
Galvanized mesh	.318 cm (0.13")	6771
Galvanized mesh	1.270 cm (0.5")	8283

Note: graphic by [Michel](#).



Troubled Times



Filaments

The lower the voltage and the higher the wattage the thicker the filament, thus the tougher. I have personally dropped on concrete a string of lit mini-bulbs while putting up Xmas tree lights around the house, and they still continued to work. Trucks and cars bounce over rough roads at night with there lights on. Flash lights get dropped and often work afterwards. There is not much mass to the filaments. While in storage the filaments are cold so as to be even tougher. Foam around each bulb should protect them. I suspect the glass might break on some bulbs before the filaments. Best test would be to package some up and drop them from a height of 500 feet or so and see if they survive.

Offered by [Mike](#).

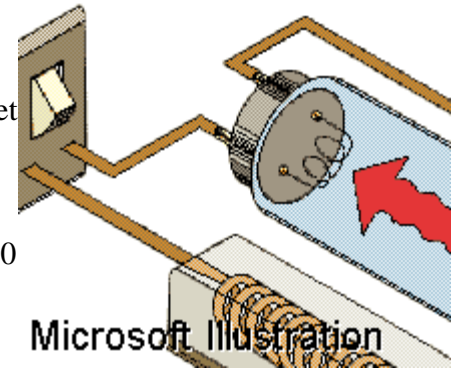

Troubled Times



Bulb Replacement

Look at what would be needed to make bulbs:

1. Suitable glass tube stock for blowing (just as fragile to store as bulbs)
2. A gas source for heating the blown glass (I think we have already discounted storing gas)
3. Gas bottles, hoses, gas torches, valves etc. (and no practical way to make gas and re-pressurize gas bottles other than producer gas maybe from coal)
4. A suitable gas for the interior of the bulb, and once again all the storage or manufacturing, and chemistry for making such a gas.
5. A vacuum pump may substitute for shorter life bulbs, but this requires skill, a very specialized skill, to draw down on the bulb to create a vacuum.
6. The skills to blow, form glass, wind elements, insert elements, make gas, fill with gas etc.
7. Element making could only be really practical if element wire stock was also stored. Imagine if we had to find and mine a suitable metal, refine it, then draw it out, and shape it. This alone totally rules out making lamps, *unless* all parts are pre-stocked.



Now why go to all this trouble to store and protect replacement parts that are equally as difficult to store as the bulbs they are meant to replace? All this to end up making vastly inferior lamps to what can be easily bought cheaply then stored. There will be millions of useless cars laying about, all containing about 10 of these lamps anyway? Coal gas heat and light and some simple reflectors for plants makes a lot more sense.

Comment by [Darryl](#).



Troubled Times



Expertise

Current thoughts on how we might make our own gas filled light bulbs in the future.

- Blow glass tubes.
- Build in a electrode at each end.
- Evacuate by using several old refrigeration compressors in series. I have tested refrigeration compressors as vacuum pumps. They pull a pretty good vacuum.
- Fill with sodium, mercury, or other substance yet to be determined.
- Seal at a given low pressure.
- Apply high voltage to start and a lower voltage to run. The longer the tube, and the higher the pressure, the greater the voltage of operation.

Would need to be further developed and tested.

Offered by [Mike](#).



Troubled Times



Home-Made

A simple plan to make a light bulb. But, it uses a 6 volt dry battery for electricity. I pass this along to others that are more capable to adapt this info to the pole shift needs.

Offered by [Mary](#).



Troubled Times



Last 100 Years

Efficiency of light output becomes a second priority when one is faced with the choice of light or no light for a very long period of time. If one has only this goal in mind, the answer is relatively easy. Use LEDs or Tungsten filament light bulbs at reduced voltage. The efficiency of the LED at producing light with the same input power over a given time frame is much greater than a tungsten filament by a factor of about 3 to 8 times. If you have a choice LEDs at reduced voltage are the first choice, however in a primitive environment many times there is no choice. One has to use what is at hand. Knowledge of what can be done with Tungsten filament bulbs is vital. Tungsten filament bulbs should not be underestimated. The Guinness Book of World Records states that a fire station in Livermore, California has a light bulb that is said to have been burning continuously for over a century since 1901 (presumably apart from power outages). However, the bulb is powered by only 4 watts. A similar story can be told of a 40-watt bulb in Texas which has been illuminated since September 21, 1908. It once resided in an opera house where notable celebrities stopped to take in its glow, but is now in an area museum.

Watts bulb1	Watts Bulb 2	Volts Bulb 2	Estimated lifetime in years	Bulb wattage ratios	watts used for combination	% of light output/Input watt	Equivalent wattage bulb for light left
7	7	61	9132	1.00	3.0	30	1
100	100	61	9132	1.00	68.6	27	19
60	40	82	22.8	1.50	31.9	38	12
75	40	93	4.57	1.88	34.0	48	16
238	100	101	1.83	2.38	91.7	60	55
100	40	104	1.50	2.50	35.8	63	22
40	7	119	0.25	5.71	5.5	98	5

By lowering the service voltage, incandescent lamps can be made to last much longer than is normal (however, their brightness and efficiency goes down as well). Lifetime is defined as the length of time when half out of 100 of the same bulbs all running at the same voltage will still be burning. The other half will have burned out. When two tungsten bulbs are wired in series, assuming the same source voltage is used, the amount of light produced is reduced and the amount of power used is less than the lowest wattage bulb (see bulb 2 column in the table). In effect the larger wattage bulb is being used as a resistor for the smaller wattage bulb that then produces the majority of the light. It turns out a 60 watt tungsten light bulb wired in series with a 40 watt light bulb will last twice as long as a typical mono-color LED's 11.4 year lifetime. The LED ends up half as bright at the end of this time. The 40-60 watt series connected tungsten light starts out 38% less bright (equivalent to 12 watt bulb) with a power usage of about 32 watts. After 22.8 years it is possibly a bit brighter than it started out. This is because some of the tungsten has evaporated from the filament making it thinner. When the wattage for each bulb is close to the same, the voltage drops in half for each bulb and both will produce light for about 9,000 years. For example if two 100 watt bulbs are used, the resulting power usage is about 69 Watts. The light output is equivalent to a 19 watt bulb, as shown in the table.

Offered by [Mike](#).



Troubled Times



Low Voltage

It is a good idea if you measure your planned primitive survival electrical system and how much it surges or changes in voltage. Estimate the change in voltages over and above 120 Volts, then drop this amount of voltage or more as a minimum for what is planned to be delivered to tungsten bulbs for a planned normal 2000 Hr lifetime. The following nomograph is usefully when calculating how much additional drop in voltage is needed to get the intended longer lifetime. Adding the amount of surge above 120 V for the generator system to the delta needed for the long lifetime and subtracting this from 120 volts gives the average voltage one should run your tungsten bulbs at to get longer lifetime.

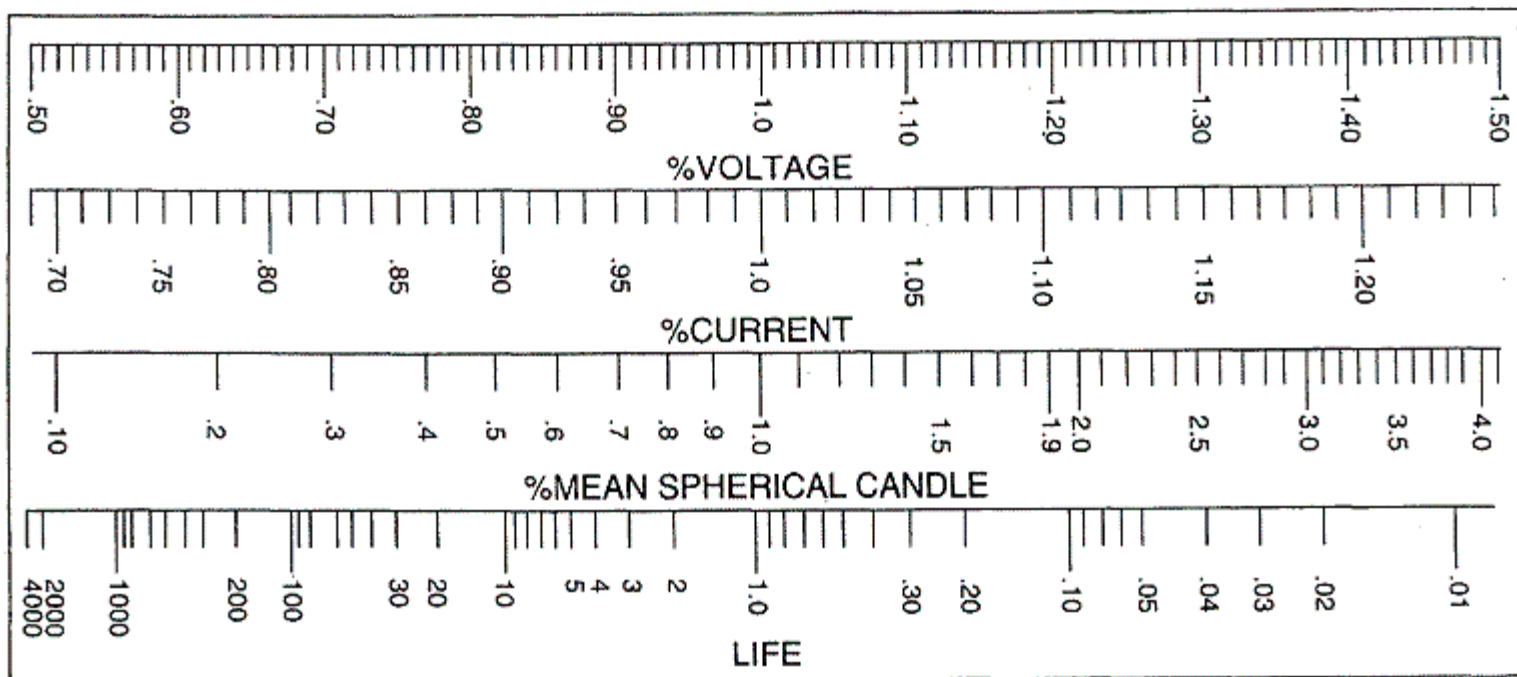

Rapid Lamp Calculator Diagram

This diagram allows the user to determine the dependence of Current, Mean Spherical Candela and Life on the value of voltage applied to the lamp as a percentage of the design voltage for that lamp. Draw a horizontal line through the percent of design voltage to be used and read the value of the calculated parameters on the right side of the diagram

Offered by [Mike](#).



Troubled Times



Long-Life Bulbs

In North America, a typical "long life" incandescent lamp is actually a 125V or 130V lamp; when operated on 120V, it can live a very long life. The lifetime of an incandescent lamp is approximately inversely proportional to the sixteenth power of the voltage. Approximately 95% of the power consumed by an incandescent light bulb is emitted as heat, rather than as visible light. An incandescent light bulb, with this ~5% efficiency, is about one quarter as efficient as a fluorescent lamp (about 20% efficiency), and produces about six times as much heat for the same amount of light from both sources.

Since it is impossible (and in fact against electrical codes) to get 130 volts from any normal mains, these typically run at a more realistic 115 volts in North America. By dropping the voltage by 12%, the current also drops (non-linearly) by approximately 7%, reducing the actual wattage by about 18%. This in turn reduces the light output by 34%, but also increases the bulb's service life by a factor of 7. This is the concept of the "[long-life bulb](#)".

A 5% reduction in operating voltage will double the life of the bulb, at the expense of reducing its light output by 20%.

Offered by [Mike](#).



Troubled Times



Fluorescent

Typically the experts say: The average lifetime of incandescent light bulbs is about 750-2000 hours. It would take at least 6-11 incandescent bulbs to last as long as one compact fluorescent light, which have an average lifetime between 11,250 and 15,000 hours. The harsh reality is for the most part we the users don't see on the market these long lasting fluorescents. Most users would currently say they both last about the same time. One reason for this is each "start" of a fluorescent lamp reduces its lifetime a little (as it blasts some cathode material off the filaments of the lamp). So if the on-off cycle of a fluorescent lamp is very short, then its life won't approach that average 10K hour number cited above. On-off cycling also has an effect on incandescent lamps, but it's much less significant, especially for lower-voltage lamps. Fluorescent lamps will not light at reduced voltage thus it becomes difficult to extend there lifetime. Near the end of it's life the intensity is much less than when new. Bottom line, for really long life we must ruleout fluorescents.

Offered by [Mike](#).



Troubled Times



Long Lasting

Concern about light bulbs burning out after the pole shift, as there seems to be no permanent light bulb, gave me an idea to build a device that will induce a gas filled bulb or tube without going through the filament of the tube like the conventional ballast method. This method I am presenting is not a new invention, it has been done by others in the past and I believe the first person who did this was Nikola Tesla, and around 1930, Tesla demonstrated with a gas filled bulb/lamp and standing near his coil, the bulb glows while he was holding it. Some of you might have done this similar experiment during your high school years yourself. The device I am presenting/built was a very simple one and it is very easy and cheap to build, and the parts are readily available. I have chosen a 12V dc base structure as the main power source with the assumption that after the pole shift, in some localities there might not be any electricity and beside the average person have access to a car and also I believe that after the pole shift there will be a lots of cars being abandoned on the road and highways due to lack of fuel. In this picture, the hV was attached to the *pin* of the fluorescent light, and this the brightest method with the power resistor bridged.

Offered by [Tian](#).



Troubled Times



Parts List

Resistors (1/4 Watt)

R1 470
R2 390
R3 220
R4 1k

Power Resistor (10W)

R5 10

Potentiometer

P1 250k

Capacitors

C1 0.01uF
C2 430pF

Diode

1N4007

Car Ignition Coil

C819AK Wal-Mart

Miscellaneous

Fluorescent tube
PC board (Radio Shack 276-150A)
IC Dip socket 8 pins
Large Capacitor bracket
Heat Sink
Heat Sink compound
22 or 24 gauge speaker wire (Radio Shack)
Double Sided tape (3M)
Stand-Off and screws
Aluminum Case/Cover

Semiconductors

LM 555 timer
IRF 540 power fet
7812 voltage regulator

Offered by [Tian](#).



Troubled Times



hV Connection

Tape both end of the fluorescent tube with the double sided tape, and wind approximately six turns with the speaker wire at each end, the first end of the winding, connect the copper color together and the tin color together. Make sure the copper color doesn't have any short with the tin color, and connect the copper color to the hVa and the tin to the hVb. The hVa is the + mark on the coil and hVb is the center big hole of the coil. The negative (-) of the coil is connected to the "D" of the mosfet. At the other end of the tube, connect this winding to the chassis ground. When the unit is turned on, the tube will glow, even the burnt-out tube will glow too. Hence do not throw away your burnt-out tube in the future, you might need it just to find your way in your dark basement. In this picture, there are two fluorescent tubes, the background tube is a brand new tube and whereas at the foreground is a completely burnt out tube, look at the black color at both end of the tube. These two tubes were connected in parallel.

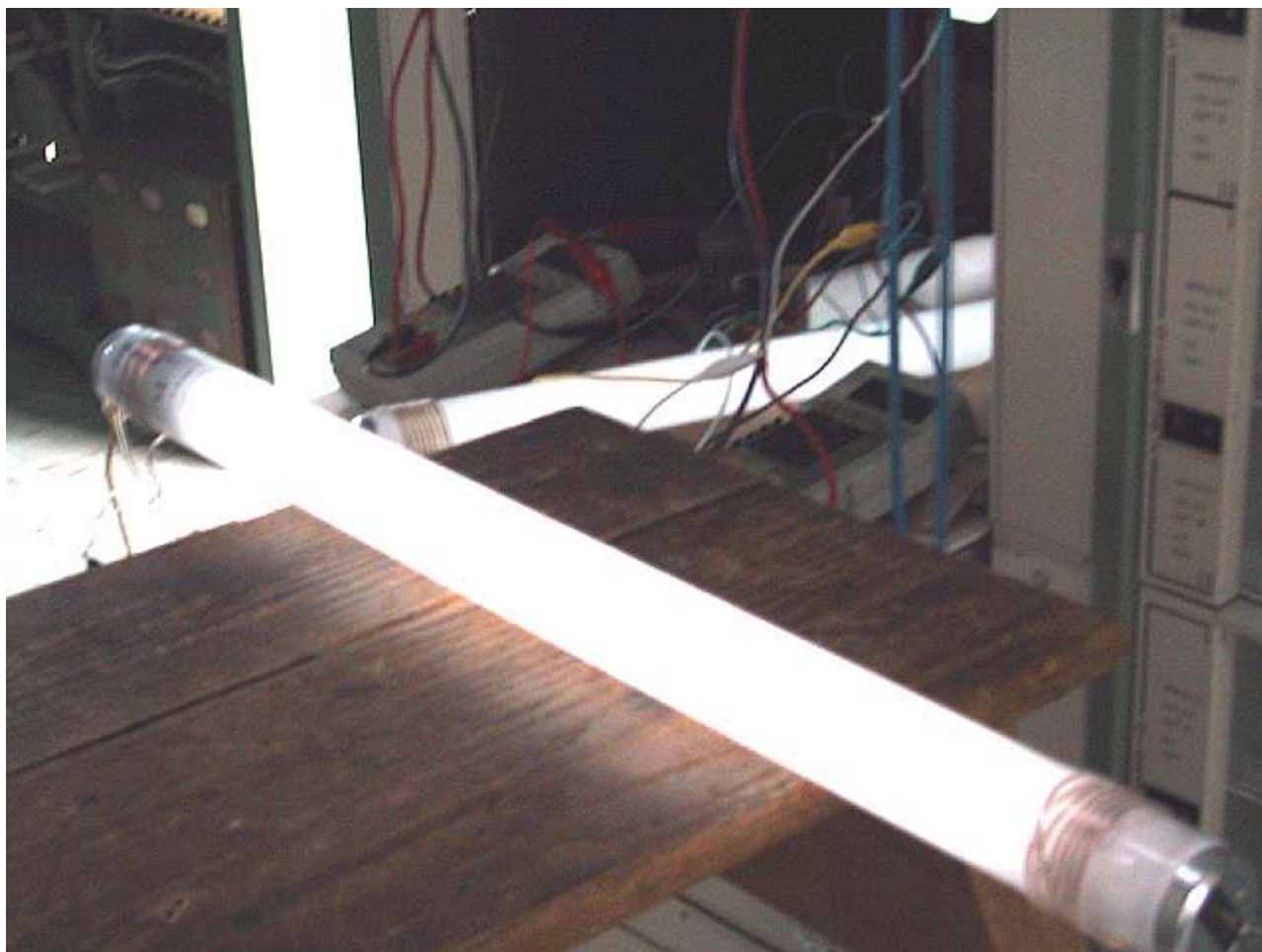

If you need to make it brighter, connect the hVa direct to the pin of the tube and the hVb on the other side pin of the tube. The brightness will double. And if you like even more brightness, the power resistor ought to be bridged. If you do this kind of arrangement, one will start smelling ozone. Is ozone good for you? The ozone, I am sure, will clear up the stale air of your basement. When this power resistor is bridged the unit will draw about 1 Amp, and the mosfet will become very hot. Make sure a large heat sink is attached to this mosfet.

Offered by [Tian](#).

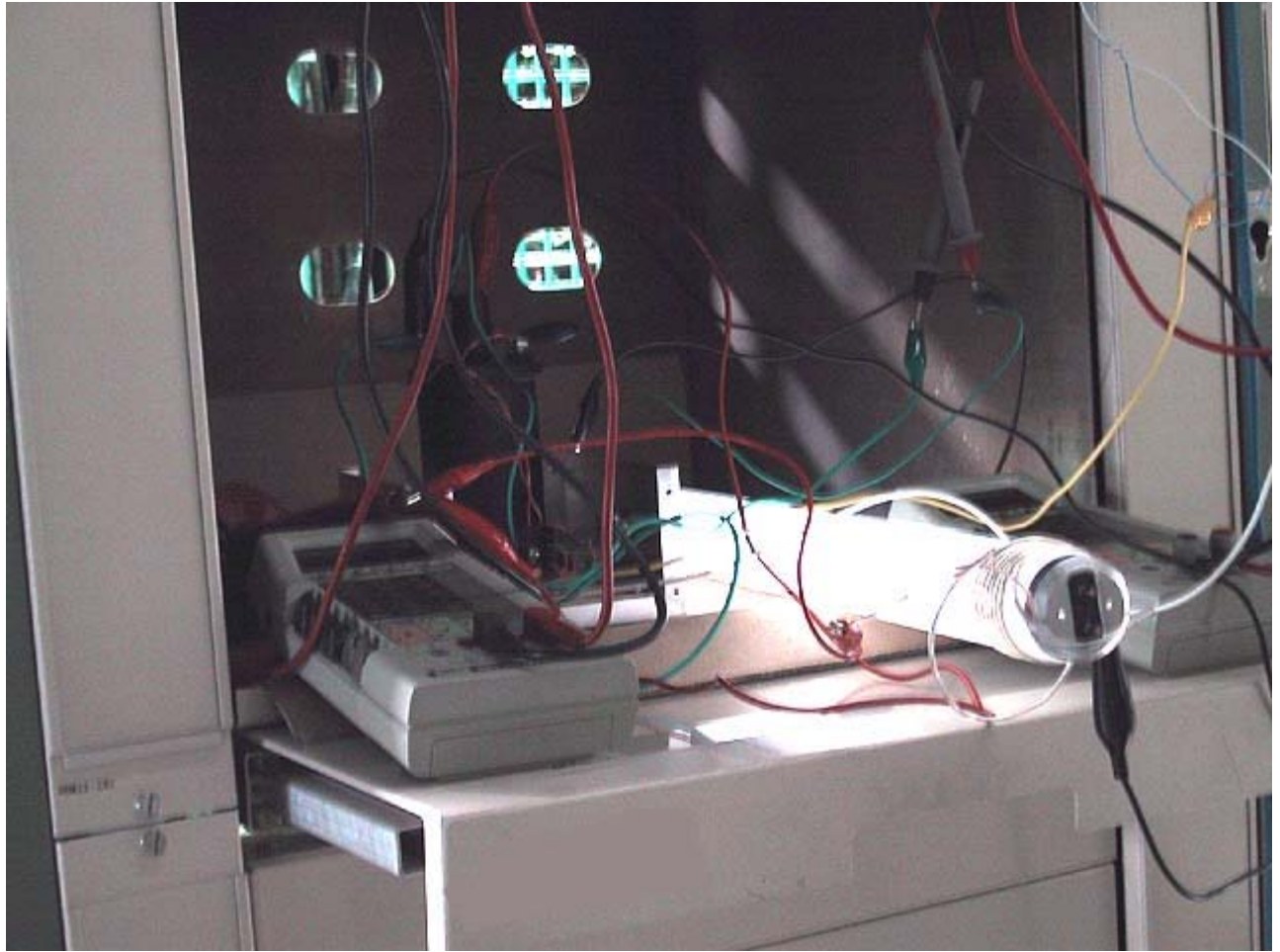

Troubled Times



Caution

Extreme caution must be taken when working with high voltages device. This is not for beginners. Oh yes, I have been zapped many times on both of my thumbs and other fingers too, and my finger print is no longer the same. This device is not meant for altering one's finger print.

Disclaimer

The Author and Troubled Times are not responsible for any mishap, injuries, damages or lost of properties due to this experiment. You will be doing this at your risk. You may copy or distribute freely but not to be sold for your own gain nor to be sold commercially.

Offered by [Tian](#).



Troubled Times



LED's

As far as light sources go the only reasonable alternative in my opinion is LEDs. LEDs are much more efficient in the conversion of electric power to light power than any fluorescent or gas discharge lamp. They can be manufactured to emit a specific wavelength of light and can be assembled to emit the precise profile needed for maximally efficient photosynthesis. At a 100% duty cycle they can be expected to last for *75 years!* A fluorescent or gas discharge lamp would have to be replaced in two years or less. One drawback is that LEDs are relatively expensive, and it would require a sophisticated infrastructure to produce them. Both of these drawbacks are answered by the benefits of the device. How will you produce them? *You won't!* But this goes for all but the most primitive of light sources.

The drawback to a primitive incandescent light source is that because of the lack of efficiency I believe the drain on electrical power generating resources versus benefit derived will not be sustainable, consider also the energy involved in producing such devices if enough cannot be stockpiled. The LED's value lies in its relative efficiency and its durability, as an indispensable link in our ability to produce food this makes the extra cost worth it. A lot of old fashioned approaches to sustainable biosystems fail when you remove the sun. *There is no life without the sun!* There will be limited electrical power generation capability. Maximum efficiency must be achieved. The most efficient path for electrical power to useable food energy for humans is: Electrical Power Source => LED Light Source => Algae =>

Offered by [Steve](#)



Troubled Times



Feasible

What a good idea and a refreshing new approach. Best are LED's in the wavelength range of say 400-500 nm (nanometer or 10^{-9} meter), which is ultraviolet and blue, and 650-690 nm, which is red. This would give near 80% or more conversion of light energy into plant growth. In case the process needs some high and low frequency, we could mix say 60% diodes at the shorter wave length and say 40% diodes at the longer wave length. This is assuming cost is not a factor.

If it takes only one sec/diode to solder them together this then is 39 days of 8 hr/day labor for each person. A population of 300 would take 31 years for one person to solder this up. If it takes 2 sec/diode then it will take about 2.5 months of labor for each person and 62 years for 300 people. Finding LED arrays would defiantly save time. Just something to consider if it works.

LED's work in a limited current range and in most applications need a currant limiting resistor. I figure voltage fluctuations could be up to .3 of applied voltage. For example: voltage regulators for 12 volt car batteries can allow charging voltage to get up to 15.5 v during full charging. During a discharge cycle one might let it go as a worst case to say 10.5 volts. Thus one would need to limit current in these LED's for a voltage charge of approximately .3 of maximum applied voltage. The internal resistance of the batteries or filament type light bulbs could be used to limit the current.

Offered by [Mike](#).



Troubled Times



Replacement

I would just like to say I have now set up a few emergency torches, using the very latest super white LED's (the series Z4004). These have only just come on the market, they use Quantum well theory and emit a "cold " white/bluish light. The LED's are good for 100,000 hours plus. In a 4-cell torch using 4 C cells the LED will operate continuously for an amazing three months per battery set, or charge. Now to make a replacement bulb, take the existing torch bulb and break the glass. Then dig out the "bog" in the base of the bulb, unsolder the two residual wires. Next get a 100 ohm, quarter watt resistor, and join one end of the resistor to the long lead on the LED (this is the positive lead). Cut off surplus wire, and solder the other end of the resistor to the center connection on the old bulb base.

Be sure to position the light area of the LED at the same distance from the bulb base so that the light will be in the same focal point of the torch reflector, for maximum brightness, and focus. Now solder the other end of the LED to the outside portion of the bulb base where the original bulb wire was soldered, re-bog it in cement if you desire, but careful measuring and soldering will mean you will have a well positioned LED without trying to re-cement it. Hey presto you now have an amazing long life light. While not quite as bright as the old bulb, it will last nearly forever, and extend torch batteries by a factor of 100 times. More LED's could be used for more light, and larger D cells would double the time the LED will run. I now have two, and some friends have ordered some from me, thought it is easy to do, and any one can make them with a bit of care (about 15 minutes at most).

Offered by [Darryl](#).



Troubled Times



Blue LEDs

I found an article about a High Luminous Intensity LED, with all the visible rays of the spectrum. It uses Indium Gallium Nitride (**InGaN**), blue chip technology combined with a phosphor coating to produce a solid state white light. This LED might be usefull to replace the conventional grow light bulb. This article was published by *Canadian Electronics* magazine, Volume 13 Number 6, September 1998 issue, and the manufacturer of those LEDs is **Data Display Products**, in El Segundo, California. The main purpose of these LEDs was for panel lights.

Offered by [Tian](#).

Since I'm not a manufacturer I forwarded this to those who are.

Offered by [John](#).

Tue, 26 Jan 1999 11:32:05 +0900

Subject: We are exporter of **Mgo** single crystal

Dear Mr John,

We are exporters of **Mgo** single crystal in south Korea. We are dealing with **Mgo** single crystal of high purity. We know that **Mgo** single crystal is used in manufacturing blue LEDS and Lasers, etc. If you have an interest in our product, contact us as below. We can supply **Mgo** single crystal for you with very competitive prices. You'll be surprised after reviewing it. We look forward to your favorable reply.

JUN-WOO.AN / Export Manager

J.J TRADING CO.,LTD

Phone 82 562 249 8132

Fax 82 562 249 1677



Troubled Times

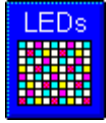

Red/Blue Balance

I got this email from **Deltalight**. He is from the person with whom I have been talking (actually pushing and prodding) concerning the creation of a more cost effective and energy efficient LED grow light.

Offered by [Steve](#).

I have a dandy circuit that will allow the user to control frequency and duty cycle via two knobs. They would have a scale printed on the housing (like the graduations on a volume control like on a stereo). This way the user can independently control frequency and duty cycle for both RED and BLUE LEDs. This of course eliminates controlling them Via an external microprocessor, but it helps keep the cost down. Feel free to repost this message in any pertinent chat room.

Bill Mack
DeltaLight77@hotmail.com

I am no expert on what intensity of red versus blue is optimum taking in to consideration price of each color of LED and plant growth that will result. I am assuming an optimum can be found. If NASA has found it and we can trust that number at 8% blue and 92% red both burning at the same frequency and relative intensity per LED then that is the answer. I think we can assume that the intensity of light is what is important. That there is nothing magical about certain frequencies causing growth (however this should be checked). I think this may be a safe assumption if we consider the Sun has no frequency to it and does quite a good job of growing plants.

Offered by [Mike](#).

My point to **Quantum** was the research says 92% red and 8% blue so just do that and don't bother with the ability to modulate. However, if you want lots of leaves you would want more blue and if you want more fruit (tomatoes), less blue, so this sort of flexibility does have a place. At the same time, you can probably save a *lot* of money by just setting a standard and going with it en masse and it will do the job (i.e. how much do you have to pay for flexibility).

Offered by [John](#).

None of that is necessary if the buyer would be willing to have just a "grow light" with a constant, fixed light output with the blue intensity and red intensity being at a level set to a nominal level. After talking with Steve and seeing what NASA was doing, the other folks who had put together the other lights wanted the ability to vary independently not only the light intensity of each of the two colors but also the frequency of the flash rate.

Hey look, as a design engineer looking for new ways to utilize light, LEDs, and state-of-the-art technology, I always try to cover all the bases to make people happy. This gives "electrical and operation foresight" in marketing a product. I figured someone might say, "well, XYZ company's model does this and yours doesn't so I'll buy from them." In this case, XYZ's company had a computer interface to vary the aforementioned parameters which I thought was great, but jacked the price high for those who would be serious enough to purchase such a light for it's exclusive purpose i.e. plant growth. I thought, "eliminate the computer, it's interface, but keep manual controls".

If I thought that 100 customers would want just a constant, fixed-intensity, light I'd be really happy as the design and construction and hence the price would be lower.

Bill Mack
DeltaLight77@hotmail.com



Troubled Times



Cost Varies

I was browsing the aisles at radio shack the other day, and saw some LED's that appeared clear to me, but claimed to be blue. Could these possibly be the same kind of blue LED I would need for indoor growing? \$2.99 for one!

Offered by [Ryan](#).

I checked with **Digi-Key** and found **Panasonic** LED's:

Blue (470nm) use 120mW at 3.5V \$2.67 each or \$24.95 for 10, \$463.32 for 200

Red (700nm) use only 70mW \$1.68 for 10 or \$27 for 200 (\$100.02 for 1000)

Of course, there is a shipping fee if the order falls beneath a certain minimum amount (I believe it is \$25), but if we're ordering to build grow lights, we will easily exceed their minimum.

Offered by [Roger](#).



Troubled Times



LED Array

We plan to use many of these LED Arrays. We will need to drive them directly from multiple types of power generators. Thus the need to be designed to withstand larger than normal voltage fluctuations. A basic array could be manufactured that runs at 12 (or 6) volts DC. It could have a double connector plug on it so that it could be plugged into other like arrays using say connector "A" and end up running on 12 Volts DC (Arrays connected in parallel) source or if plugged into the other connector "B" it would run on 120 volts DC (10 arrays connected in Series) power source. This would satisfy 12 and 120 Volts DC power sources. To run on AC one would have two of the resultant 12 volt or 120 DC assemblies, with the second assemblies (Diodes one way flow) conducting in the opposite direction to balance the electrical load on the AC source.

120 volts is more readily available and uses much smaller wire to bring the power from the generator (windmill, water wheel generator) to the light array. Each array may drop 12 Volts but 10 or more will be put in series to hook directly to a 120 AC or DC source. Each array will still have the same 12 Volts across it no matter the ultimate source voltage. Most houses today use 120 Volt capable fixtures, so this becomes easy to find wire and fixtures.

As a consumer who would be extremely interested in purchasing such a light, I would say that that the major purchasing considerations in order of importance are: Low cost, energy efficient with lots of resultant plant growth, long life, able to withstand larger than normal voltage fluctuations, able to run on 120 Volt and 12 Volt AC or DC, easy to add on multipliable arrays to get as much light as needed. The power sources for these units will often be windmills and water power, with a resultant expected fluctuation in over all voltage to be larger than standard on the grid power. I believe that frequency and intensity of each light array would not need to be controlled but could be set to full on for most efficient operation under the above considerations.

Offered by [Mike](#).



Troubled Times



Expensive

GELcore

I finally got hold of Bill Kroll, VP of marketing for **GELcore**. While they weren't particularly interested in developing a grow light, he gave two names of his customers that use their LEDs that probably would.

[Opto Technology](#)

Tom Heckburg of **Opto Technology**, 847-537-4277, is sending me a packet of info outlining their engineering costs and capabilities. He "guestimated" about \$3,000 to come up with an engineering prototype with pricing determined by the number of units they can reasonably expect to sell.

[Dialight](#)

Gary Durgin, VP of marketing of **Dialight**, 732-528-8910, is going to meet with his engineers about the project. They have an existing application in traffic light LED systems that may have LED and design specs similar to a grow light. As busy as they are, he said he would get back to me in 3-4 weeks.

So between the three of them, I may be able to coerce, err, encourage a viable and hopefully cost effective LED growlight system.

Offered by [Steve](#).



Troubled Times



GELcore

It looks like to me this company has figured out how to make a high brightness cheap blue LED. We need some volunteers to approach them to make blue and red 12 Volt DC arrays for plant growth.

Offered by [Mike](#).

The high brightness Blue LED technology was developed in-house, showing excellent device characteristics ($P > 1000 \mu\text{W}$) and uniformity on the largest GaN multi-wafer system used in blue LED production in the world (6 x 2"). GE Lighting, EMCORE Corporation Form Company to Enter Global Lighting Market with 'White Light' LEDs New company to be called GELcore LLC. The companies have targeted the second half of 1999 for the introduction of its first commercial white light products.

LEDs offer numerous advantages over conventional lighting, including a lifespan of more than 100,000 hours, enhanced durability, compact design, and dramatically reduced energy consumption. GELcore will produce proprietary LEDs by converting Gallium Nitride-based blue semiconductor devices to white light through the combination of phosphors and plastics. GELcore will develop a range of high-brightness white light and colored LEDs for automotive, traffic, flat panel display, and other specialty lighting applications.



Troubled Times



LED Clusters

Price will come down with time. Availability will increase. Good to see this start to show up in the market (May 99).

[Jade Mountain](#) Cluster White LED's: The Next Generation of Super Energy Efficient Lighting
1.5 watt **Cluster LED** 12V Light

Offered by [Mike](#).



Troubled Times



LumiLEDs

LumiLEDs Lighting Produces 17 Lumen White LED

Products Available in Upcoming Luxeon™ Product Family

San Jose, Calif. Feb. 26, 2001

LumiLEDs Lighting, the leader in high flux, high powered LED (light emitting diode) technology, today announced it has demonstrated a single white LED with output of seventeen lumens. This is four times more white light output than the best known white LED. This device operates at 350mA and 3.2Vf.

This is a significant breakthrough as it is the first demonstrated single point white LED light source that is in the light output range required for general lighting- such as map lights, airplane reading lights and emergency lighting. A well-controlled single point light source allows lighting designers to design sleek, compact fixtures and couple the light to a single optic in the light fixture. This is not possible with traditional low power 5mm white LEDs, due to the multiple LEDs required, leading to a wasteful loss of light and a bulky, clumsy design.

LumiLEDs Luxeon™ technology offers a unique platform for these breakthroughs- combining light extraction techniques, cutting-edge LED technology, and high power capabilities.



Troubled Times



Sources

This site has a lot of interesting useful LED and lighting information. Don Klipstein's Web Site!

[Dialight](#) states:

We are one of the largest producers of indicators for circuit boards, instrument panels, and LED lighting for buses, trucks, and traffic signals.

Offered by [Mike](#).

My [White LED](#) source. \$1.50 each in minimum quantities of 50.

Offered by [Gary](#).



Troubled Times



How to Wire

Basics of wiring LEDs.

<http://www.misty.com/people/don/ledd.html>

<http://www.theledlight.com/LED101.html>



Offered by [Gary](#).

The over all goal is to build the most energy efficient long lasting lighting for "primitive environment use" from commonly available items. Properly driven or powered LEDs are well suited for this purpose. Given some proper size resistors, x-mass tree bulbs, or LM317 integrated circuits and white or colored LEDs highly efficient primitive task lighting can be made.

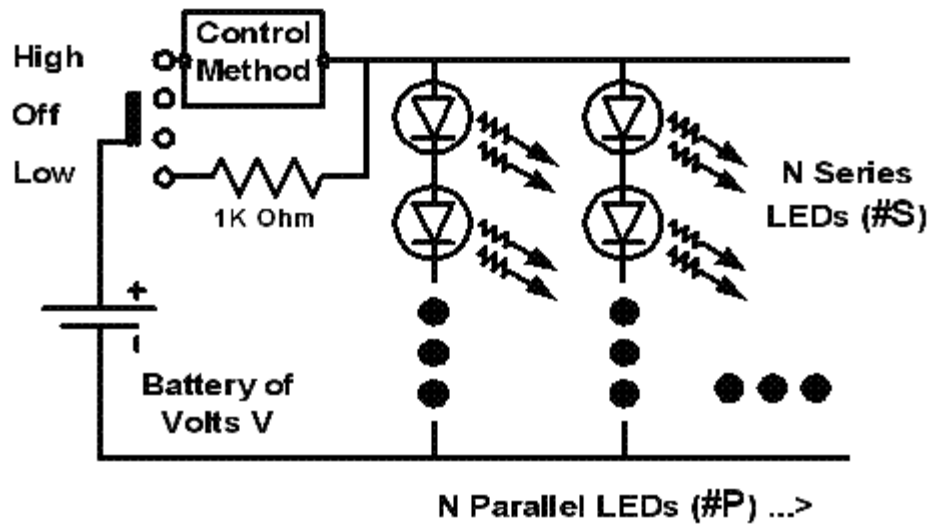
Simple Current Control Methods for Driving LEDs

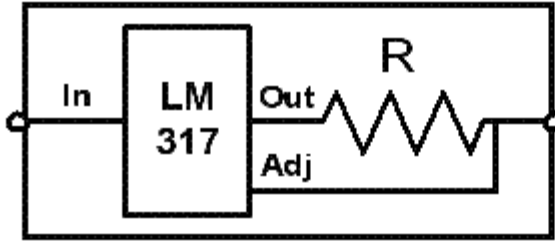

Control Methods

- 1)  R Ohms
- 2)  N Series Connected X-Mass Tree Mini-Bulbs
- 3)  $R = 1240/ma$ (5 to 250 ma makes R 250 to 5 ohms) Bat V 3 to 37 Volts

Offered by [Mike](#).



Troubled Times



Three Methods

The first method is to use a proper size resistor in series with the LEDs. The resistance value is chosen to limit the flow through the LED at maximum voltages the battery will operate at (usually during charging). The second method is to use the proper number of series connect x-mass tree bulbs as a varistor (change in resistance with increase in voltage). The positive increase in resistance with increase in current is used to advantage and this method is more efficient at producing light than a simple resistor. The third method of driving LEDs is by use a LM 317 integrated circuit chip in series with a resistor that limits current to given value over a wide range of input voltages. This method works best when input voltage is expected to vary over a wide range. The following shows the resulting current for different values of R.

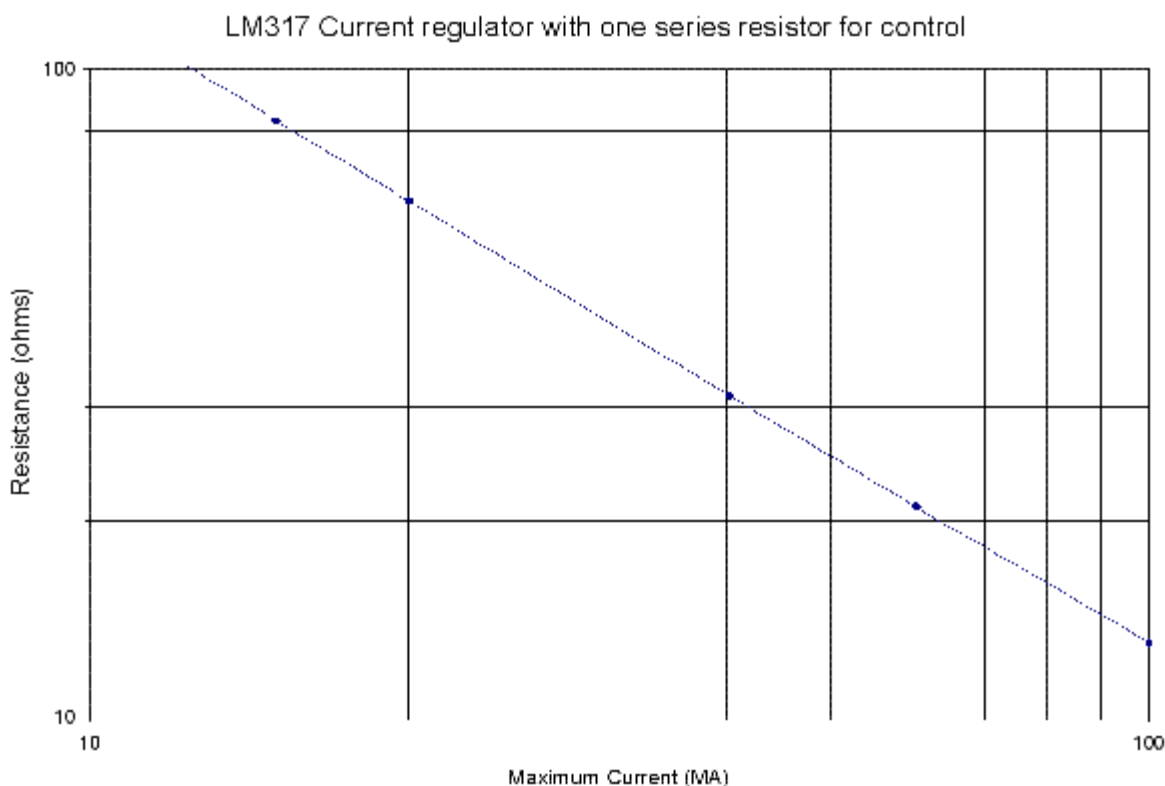

Offered by [Mike](#).



Troubled Times



Lower Voltage

The lifetime of the currently available white LEDs is not anything near the 100,000 hours of mono color LEDs. More typically it is about 5,000 to 30,000 hours at 20ma. The lifetime is related to how hot the junction gets during operation. As a result it is highly recommended that one design for half current or 10 ma to gain a significantly longer lifetime. Optimum design for a number of different input voltages was chosen based on limiting the LED current for the highest voltages that could occur during operation. The following table gives the different battery configurations chosen. AA is assumed to be a typical fully charged Ni-Cad or Ni-MH cell or a typical alkaline cell that averages in operation about 1.2 volts. It is assumed the cells are not being charged while the unit is in operation. A high of 15 volts for the typical 12 volt lead acid battery is assumed to be maximum charging voltage. In this case it is assumed that charging occurs during operation of the lighting. The following table shows the assumed voltages for design purposes.

	Volt for each Cell	Volt for 4-AA Cells	Volt for 8-AA Cells	Volt for 12 volt Battery
Low	1	4	8	11.5
Average	1.2	4.8	9.6	12.5
High	1.6	6.4	12.8	15

Offered by [Mike](#).



Troubled Times



Optimum Design

Optimum design for a number of different LED configurations and average battery voltages is given in the following table. The last column gives the resistance values needed in the circuit for the approach chosen. Graph [F1](#), [F1a](#), [F2](#), [F3](#), [F3a](#), [F3b](#), [F3c](#), [F3d](#), [F4](#), [F4a](#), [F4b](#) are available.

Graph	Circuit Name	Type Driver	# of Cells	Battery Voltage	# of LEDs	R ohms
F1	1S-1P-6W-20	6 W-20 X-mass bulbs	4-AA	4.8	1	53.0
F1	1S-1P-CC15	Const current 15 ma	4-AA	4.8	1	82.0
F1	1S-1P-R160	Series Resistor	4-AA	4.8	1	160.0
F2	2S-1P-6-W-20	6 W-20 X-mass bulbs	8-AA	9.6	2	53.0
F2	2S-1P-CC15	Const current 16 ma	8-AA	9.6	2	82.0
F2	2S-1P-R320	Series Resistor	8-AA	9.6	2	320.0
F3	3S-1P-10W-20	10 W-20 X-mass bulbs	6 Lead	12.5	3	85.7
F3	3S-1P-CC15	Const current 15 ma	6-Lead	12.5	3	82.0
F3	3S-1P-R270	Series Resistor	6-Lead	12.5	3	270.0
F3a	3S-2P-12-D-35	12 D-35 X-mass bulbs	6-Lead	12.5	6	76.0
F3a	3S-2P-2-W-20	2 W-20 X-mass bulbs	6-Lead	12.5	6	18.4
F3a	3S-2P-3-W-20	3 W-20 X-mass bulbs	6-Lead	12.5	6	25.7
F3a	3S-2P-CC20	Const current 20 ma	6-Lead	12.5	6	62.0
F3a	3S-2P-CC30	Const current 30 ma	6-Lead	12.5	6	41.4
F3a	3S-2P-R130	Series R=130	6-Lead	12.5	6	130.0
F3b	3S-4P-3-D-35	3 D-35 X-mass bulbs	6-Lead	12.5	12	17.8
F3b	3S-4P-4-T-50	4 T-50 X-mass bulbs	6-Lead	12.5	12	11.0
F3b	3S-4P-CC40	Const current 40 ma	6-Lead	12.5	12	31.0
F3b	3S-4P-CC60	Const current 60 ma	6-Lead	12.5	12	21.0
F3b	3S-4P-R67	Series Resistor	6-Lead	12.5	12	67.3
F3c	3S-6P-4-W-35	4 W-35 X-mass bulbs	6-Lead	12.5	18	16.0
F3c	3S-6P-5-W-50W	5 W-50w X-mass bulbs	6-Lead	12.5	18	8.7
F3c	3S-6P-CC60	Const current 60 ma	6-Lead	12.5	18	20.5
F3c	3S-6P-CC90	Const current 90 ma	6-Lead	12.5	18	13.7

F3c	3S-6P-R44.7	Series Resistor	6-Lead	12.5	18	44.7
F3d	3S-7P-3-W-35	3 W-35 X-mass bulbs	6-Lead	12.5	21	7.2
F3d	3S-7P-4-W-35	4 W-35 X-mass bulbs	6-Lead	12.5	21	12.6
F3d	3S-7P-CC84	Const current 84	6-Lead	12.5	21	15.2
F3d	3S-7P-R39.9	Series Resistor	6-Lead	12.5	21	39.9
F4	4S-1P-3W-20	3 W-20 X-mass bulbs	6-Lead	12.5	4	24.3
F4	4S-1P-4W-20	4 W-20 X-mass bulbs	6-Lead	12.5	4	33.7
F4	4S-1P-5W-20	5 W-20 X-mass bulbs	6-Lead	12.5	4	44.7
F4	4S-1P-CC14	Const current 15 ma	6-Lead	12.5	4	82.0
F4	4S-1P-R110	Series Resistor	6-Lead	12.5	4	110.0
F4a	4S-2P-1-W-20	1 W-20 X-mass bulbs	6-Lead	12.5	8	8.1
F4a	4S-2P-4-G-50	4 G-50 X-mass bulbs	6-Lead	12.5	8	17.2
F4a	4S-2P-8-G-50	8 G-50 X-mass bulbs	6-Lead	12.5	8	31.0
F4a	4S-2P-CC30	Const current 15 ma	6-Lead	12.5	8	41.0
F4a	4S-2P-R56	Series Resistor	6-Lead	12.5	8	56.0
F4b	4S-4P-2-D-35	2 D-35 X-mass bulbs	6-Lead	12.5	16	33.0
F4b	4S-4P-2-G-50	2 G-50 X-mass bulbs	6-Lead	12.5	16	7.5
F4b	4S-4P-2-T-50	2 T-50 X-mass bulbs	6-Lead	12.5	16	5.3
F4b	4S-4P-3-T-50	3 T-50 X-mass bulbs	6-Lead	12.5	16	8.0
F4b	4S-4P-R40	Series Resistor	6-Lead	12.5	16	40.0

4S-4P in the above table stands for 4 LEDs are connected in Series and there are 4 parallel connected sets of the 4 series LEDs. This results in a total of 16 LEDs. 2-W-20 stands for a quantity of 2 of the W-20 type X-mass tree bulbs. W stands for Wal-Mart and 20 is the number of bulbs in the original string.

Offered by [Mike](#).



Troubled Times



X-mass Tree

The following wiring diagram is typical for x-mass tree bulbs. It can be used to help determine how many parallel combinations of N bulbs are in each string.

X-MASS TREE BULB STRING WIRING DIAGRAMS

Three wires twisted together indicates 2 or more parallel connected N bulb series connected strings

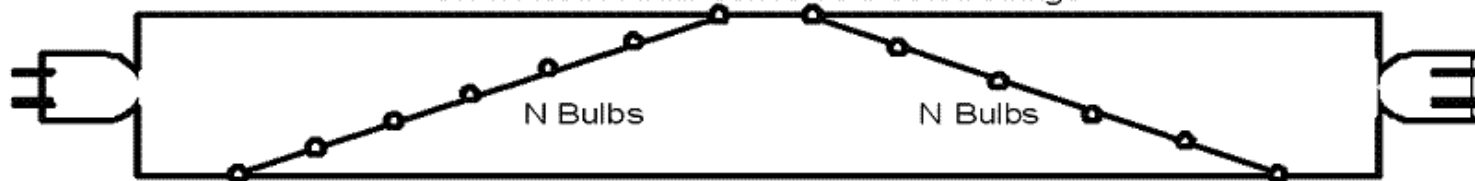

Total bulbs in string = 1,2,3,4 or more times N.
Voltage of each bulb = $120/N$

One or two wire is one series connected string



Total bulbs in string = N.
Voltage of each bulb = $120/N$

The number of bulbs hooked across 120 volts AC determines the operating voltage for the bulb. This then is the maximum this bulb should operate at. Reducing the voltage to 82% of the original will increase the lifetime by 10 times. Reducing the voltage to 68% of the original will increase the lifetime by 100 times.

# of Bulbs per 120 Volts	Volts per Bulb
20	6.0
35	3.4
50	2.4
100	1.2

Offered by [Mike](#).



Troubled Times



Characteristics

The following table lists the characteristics of the typical miniature x-mass tree bulb. The current for the bend in the curve gives the point of best operating point for these bulbs. This bend in the curve current should be chosen to be between half and $\frac{3}{4}$ the intended operating current for the LED.

X-mass tree bult type and cost	Bulb ID	Color of light	Lux per bulb	Watts full string	Max Amps per bulb	Max Volts per bulb	Ohm Cold	Ohm Hot	Amps at Bend in Curve
Holiday Time from Walmart 100 CT mini light set (white wire) \$1.98	W-50w	white	2450	36.0	0.164	2.420	1.8	16	0.066
Targets 100 mini light set (green wire) \$1.99	T-50	white	1740	18.0	0.101	2/420	2.8	26	0.039
Walmart 20 light set (green wire \$.97)	W-20	white	4300	6.5	0.073	6.050	8.4	101	0.016
Walmart 70 mini light set (green wire) colored light \$4.46	W-35	multi	680	46.0	0.210	3.457	2.3	18	0.060
Walmart 100 mini light set (green wire) white light \$1.98	W-50g	white	2830	38.0	0.155	2.420	1.7	16	0.064
CVS Pharmacy "Merry Midget" 100 white light green wire minature set \$1.99	C-50	white	2160	36.5	0.155	2.420	1.7	16	0.064
99 Cent store "Santa's Finest" 35 clear color	D-35	white	2450	12.0	0.118	3.457	3.5	33	0.040
Walgreen's \$1.99 50 light clear set 12 ft	G-50	white	2360	9.0	0.109	2.420	3.3	28	0.035
Alan Party Supply Co "Deco Lights" Walgreen's \$2.99 20 light clear set 8 ft	A-20	white	4480	13.0	0.125	6.050	5.4	55	0.028
Holiday Tradition 35 bulb miniature set \$.99	H-35	white	2820	12.0	0.109	3.457	3.7	35	0.034

Offered by [Mike](#).



Troubled Times

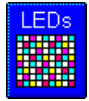

Optimal Curve

The following graphs show the typical curves for voltage and current for miniature x-mass tree bulbs.

All-20

6.05V at 72-125ma for 20 bulb X-miss mini bulb strings

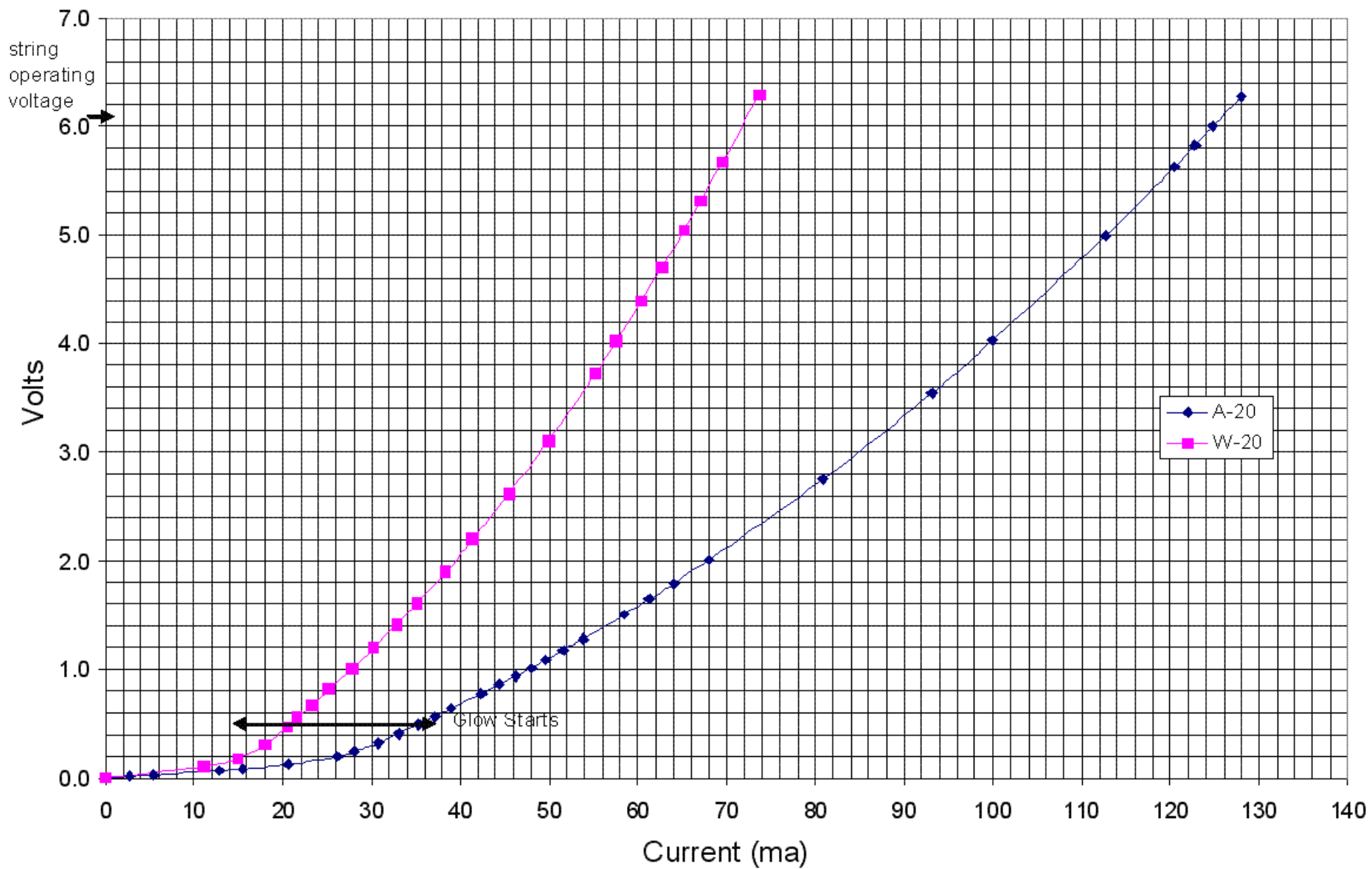

All-35

3.46V at 119-210 ma for 35 or 2x35=70 X-miss mini bulb strings

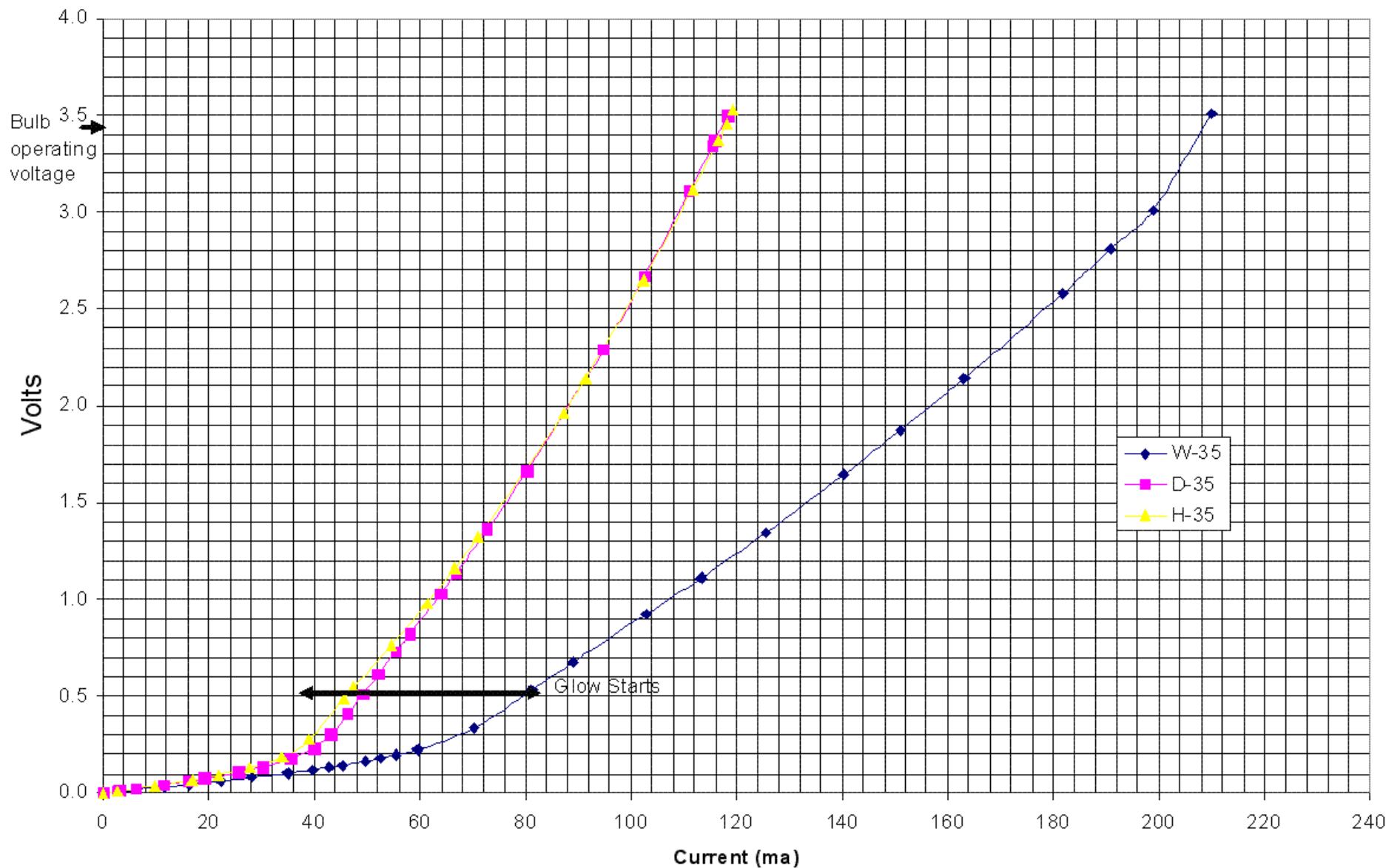

All-50

2.42V at 92-162ma for 50 or 2x50=100 X-miss mini bulb strings

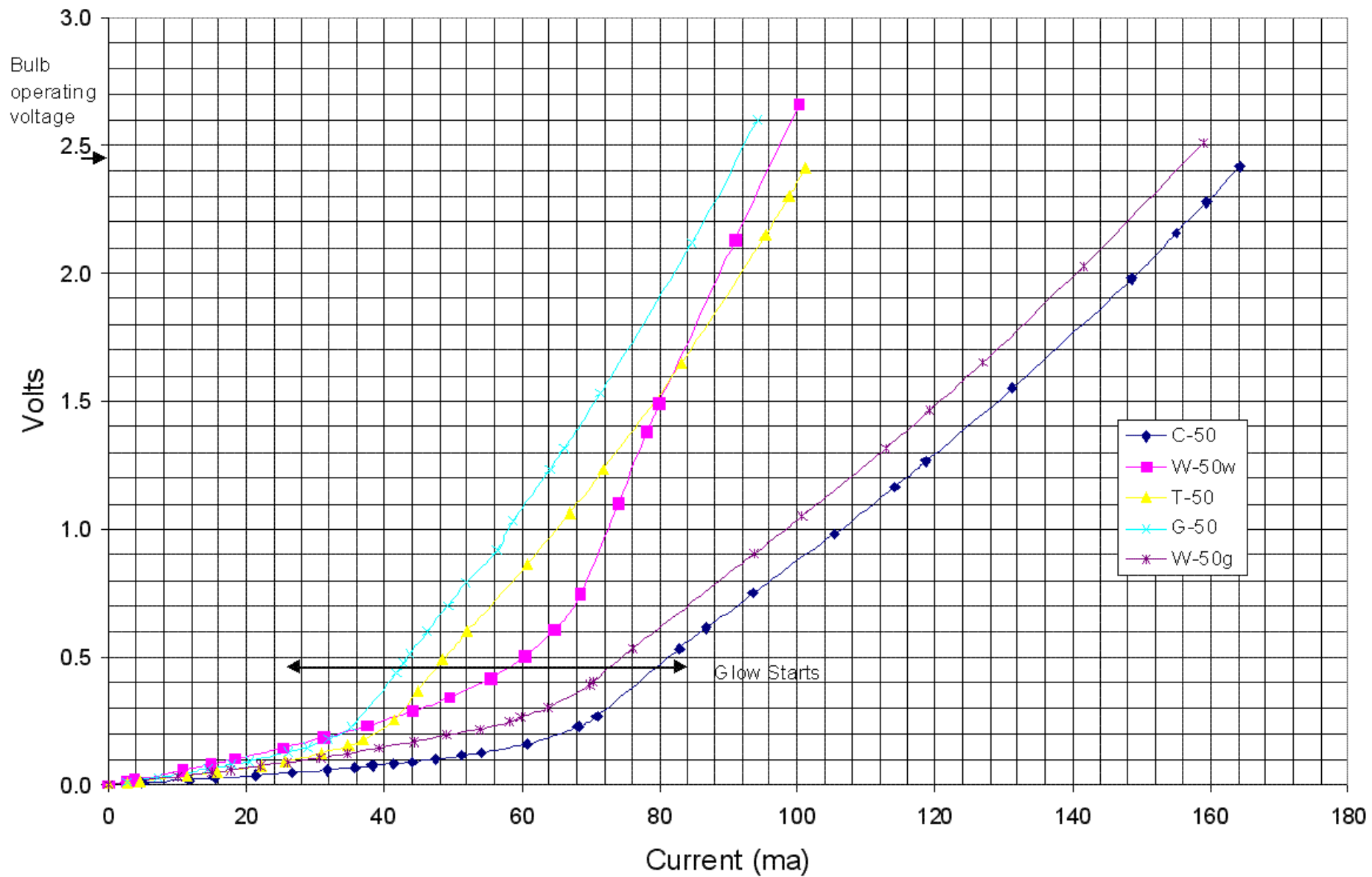

Offered by [Mike](#).



Troubled Times

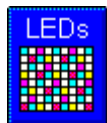

Pro/Con

A series resistor to limit LED current has the following advantages and disadvantages.

Advantages:

1. Given the right size resistor it is simple to implement.
2. Is relatively small and non-breakable.
3. Can be used safely when operating current does not need to be controlled over a broad range.

Disadvantage:

1. Straight line characteristics make for energy inefficient current protection.
2. Should not be used when "design to" voltages are over a broad range. Has the least protection for the high current end of all of the 3 driver methods tested. Because primitive environments need to operate in broad voltage and current ranges this approach becomes the least workable one.

X-mass miniature tree bulbs used as variable resistor to limit LED current have the following advantages and disadvantages.

Advantages:

1. Is the most energy efficient method of driving an LED to produce light. Allows more light in usable current range while protecting a bit better than a resistor at the high end.
2. Is more likely to be available after a PS than resistors.
3. Will last a long time at reduced currents before burn out.

Disadvantages:

1. More prone to developing corrosion at the socket to bulb mechanical connection. Recommend soldering when one can do this. They do need special cleaning if soldered.
2. One needs to match typical current flow to be greater than bend in resistance curve. Takes a bit of trial and error.
3. The bulbs are fragile and can break if not protected.
4. Current surge when cold is more than a resistor and may in the long run slightly shorten LED lifetime.

The use of an LM-317 integrated circuit in a constant current circuit configuration driven by a wide ranging voltage values as a driver circuit for LEDs has the following advantages and disadvantages.

Advantages:

1. Will work up to voltages of 37 volts and still hold the current to a given maximum depending the value of the control resistor.
2. Low cost and easy to implement. Provided some chips are purchased and stored before the PS.
3. This is by far the safest most protected way to drive LEDs. Keep the current below a given value for all input voltages.

Disadvantages:

1. They use a bit of energy taking in about 2.3 volts of overhead. This is the minimum drop across the unit that is needed to control current. Thus they are not the most energy efficient way of driving LEDs.
2. They would not be readily available after a PS. Would need to purchase them before.

Availability:

LM317LZ (small size no heat sink) Jameco# 23552 cost \$.23/each

LM317T (bigger with heat sink) Jameco# 23579 cost \$.45/each

Go to [Jameco](#) h and type in the part number.

Resistors can be ordered from [Digikey](#). As examples:

82 ohm 82H-ND cost \$1.89/100

160 ohm 160H-ND cost \$1.89/100

110 ohm 110H-ND cost \$1.89/100

LEDs can be ordered from [Ebay](#). Search for "white led mcd 100" or whatever color you want. Some of the Highest MCD are the newest or the narrowest beam angle. These are not necessary the longest lasting. To determine lifetime one needs to ask detailed questions to the seller. Even then it is not that easy. Good luck.

Offered by [Mike](#).



Troubled Times



LED Cost

The best LEDs for plant growth are at about 430 nm and 680 nm. Blue 430 nm LEDs are very expensive \$2-\$3 a piece. Until I am ready to make refinements I am not willing to shell out those kinds of bucks. I am going to see if the 80-20 rule can be applied in this case, that is that 80% of your result can be achieved through 20% of your effort. The cheapest source of LEDs I have been able to find is from **Jameco**, they sell a one pound grab bag of LEDs for about 36 bucks, probably all red, green and yellow, a total of 1900 LEDs at about 2 cents a piece. I estimate that will create about an 84 Watt light panel, as I can afford it I will expand on it. Cheap sources of LEDs would be needed for such a project if you consider the large energy values involved, we're talking about replacing the sun here.

So, how many LEDs will it take? A 5 kW LED light panel is huge, 158 square feet. Gee, I wonder what an equivalent 20 year supply of sodium vapor lamps would cost? The power generating requirement would be greater too. Efficiency is the key to making the whole system work. To measure efficiency in the test reactor what one really needs is an sensor to measure oxygen generation. Otherwise one would have to spend a lot of time taking samples and doing chemistry, it will really slow things down.

LEDs are not characterized by light power output, but by luminous intensity, you can arrive at light power output by doing some calculations. A typical super bright LED I checked (I was not drinking) showed to be about 35% efficient. There are special high efficiency types that are even better than this, but cost more, the trick will be to tweak the design so we get the highest efficiency at the lowest cost. How does this compare to a sodium vapor lamp? Looks like a 400W sodium vapor lamp is about 21% efficient. By the way, blue LEDs are out, it appears that the typical efficiency for a blue LED is about 1%, the cost is prohibitive also.

Offered by [Steve](#)

[Sharp](#) produces Blue Led, High Luminosity Led, and Super High Luminosity Led, and others are Full Color LED Units, Chip LED, Laser, IR. Devices, and Fiber. There is a problem with discarding Blue LED's because they are very costly. Problem is according to the summary published by NASA in conjunction with several universities is Blue is essential to plant growth. Recommendation from that study is from 1% to 20% blue LED depending on plant and growth requirements.

Offered by [John](#).



Troubled Times



Demo

Quantum Device's snaplite has been used in labs for testing purposes and I had it demo'd for me a few months ago. Based on the demo was not at all sure of the ROI (return on investment) for the \$3,000 snaplite vs. halide. I think they really undersell what they have here. One snaplite uses about 45 watts of electricity! Compare that to the 1000W halide! I also think it will cover a lot more than the 2x2 square they have been telling me. I've seen it turned up to its full 45 watt power and to me, there is plenty of light over 100sq. ft. vs. 64 sq. ft. for metal halide. But that's my perception.

It only uses red and blue diodes, and hits the spectrum points identified as those that plants appreciate, and there have been several studies that are on the web that the red spectrum at about 90-93% and blue from 7%-10% work best for growing. It's not a bulb, it's LED's (light emitting diodes) - 200 to a unit. Quantum has pointed out to me that light from the unit dissipates geometrically. Therefore, they only think it works for about 4 sq. ft. which is not enough. But no one has really tested it because their customers are scientists that are looking to increase the growth rate of plants, and don't seem concerned about cost (NASA as an example!).

Offered by [John](#).



Troubled Times



Lumens/Watt

Samplings of a table entitled [Efficiencies of Illuminants](#) from the *CRC Handbook of Chemistry and Physics* 59th Edition

Lamp Efficiency	lm/lamp W (Lumen pre Watt)
Tungsten filament, gas filled (3200 K)	33.5
Flourescent (cool white) Rapid start (T12)	78.8
Mercury vapor (E-37) Deluxe White	56.3
High-pressure sodium (Lucalox) 400 Watt	125.0
Electric arc, High intensity	31.4

When it comes to energy efficiency you just can't beat good ol' high voltage AC. Electrochemical processes such as in car batteries are anything but efficient. Batteries are good for backup power, but if efficiency is the name of the game better keep them out of the loop most of the time. The light panels can be wired to run off either 120V AC or 12V DC. The power levels involved are too high to consider running off low voltage. A 50 kW light would require over 4000 amps at 12 Volts. You don't use limiting resistors in the design, the LEDs are just strung together until they form the appropriate voltage drop. For example I am using a typical LED with a Voltage drop of 2.2V at 20 milliamps, so to come up with say 12V you would string about seven of them together. They will operate within a wide range of voltage, although if you want to prolong the life of the LEDs don't exceed their rating for too long.

Offered by [Steve](#)



Troubled Times

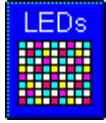

Life Span

I have attempted to formulate an apples to apples comparison between three different light sources showing the relative cost, efficiency and durability. One is what I consider to be a best case conventional light source, the **high pressure sodium vapor lamp** (HPS). One I consider a worst case conventional light source, automobile headlamps. And a new hybrid light source which is composed of light emitting diodes (LEDs) and a blue luminous tube. This last one, I think, represents our best hope as a light source for use in growing plants without sunlight. For this example a 23 year time span was chosen. The normal factor is biological activity of light output of 36 lightwatts for 23 years (continuous). The HPS chosen for this example is a GE LU250/SBY. It has a secondary arc tube which becomes active when the primary tube burns out, this gives it an outstanding 40,000 hour life.

Light Power Output: 36 lightwatts (assumed 100% biological activity)
Power Requirement: 250 Watts
Efficiency: 14%
Cost (at discount): \$137 (cost does not include fixture)
23 Year Supply: 5 lamps
Total Cost: \$685

Typical **automobile headlamps**. 12 Volts, 2 amps. These lamps have a very short 300 hour lifespan and are not very efficient. However, since there will be many abandoned vehicles around you might even be able to get these for free.

Light Power Output: 72 lightwatts (assumed 50% biological activity)
Power Requirement: 1440 Watts (60 lamps used simultaneously)
Efficiency: 2.5%
Cost: \$5
23 Year Supply: 40,296 lamps
Total Cost: \$201,480

Next is a **composite neon/LED** light source that is not now produced for the consumer market, but is well within existing manufacturing technology. NASA is currently using a similar light source for research into advance life support systems for space travel. The LED component has a lifespan of several decades, it is also very efficient. The luminous tube portion provides 10% of total light output. Since this device does not exist an attempt was made to derive realistic figures.

Light Power Output: 36 lightwatts (assumed 100% biological activity)
Power Requirement: 192 Watts
Efficiency: 19%
Cost: \$493
23 Year Supply: 1 (with the ability to rebuild the tube)
Total Cost: \$493

These figures are believed to be realistic based upon catalog references and engineering data. The conclusion I hope you draw from this is that the LED/tube light source is superior. If you have the ability to rebuild the tube you can use this light source for many decades. One may consider just replacing the tube part from stockpiles. Even without the tube it will produce plant growth but at a reduced rate. The LEDs will not all fail at once if they are not abused. They will fail one at a time after many years giving gradually reduced output, and are very tolerant to mechanical shock. The values given are somewhat pessimistic, and can be improved upon.

The HPS or similar lamp would be more expensive to stockpile and would not give you quite the quality of biological light output as the LED/tube and is not quite as energy efficient. The HPS is fragile, and is not rebuildable, so when they're gone they're gone. Even assuming automobile headlamps are easy to come by I hope you can see by the example the disadvantages of the need for huge stockpiles and the low energy efficiency. This should discourage you from considering it a viable alternative.

Offered by [Steve](#)



Troubled Times

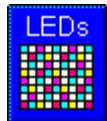

Other Sources

There seems to have been a lot of focus on small incandescent light sources run by 12 V batteries. The proper application for these in a living situation is reading lamps and task lights. Their effect on biological life support is trivial because of their inefficiency, short life, and disposability. The focus for biological life support lighting should shift to high efficiency, long life, rebuildable light sources.

There is some very interesting work being done at NASA. They are testing the use of LED's as a light source for photosynthesis. The gist of it is, you can do photosynthesis with just red LEDs, but not very efficiently. Their data show that by adding just 10% blue light photosynthetic efficiency is greatly increased, even over the results achieved by their white light baseline. The data I've seen on blue LEDs shows that they are not suitable for our application. They are very inefficient and costly. Conventional fluorescent lamps can be expected to last no longer than two years. I do not recommend the use of conventional fluorescents, they are fragile and as any consumable light source they are not manufactured in such a way as to make repair or rebuilding practical. The only suitable light source I am aware of that is long lasting, routinely rebuildable, and can be made to be efficient, is the luminous tube, better known as the neon light.

Offered by [Steve](#)



Troubled Times



Neon

True, specialized skills and equipment are required to build and repair luminous tubes. They can be made to provide a source of ultraviolet light which will be indispensable. Vitamin D cannot be synthesized in living systems without UV light. Unless we want to depend on supplements, the use of UV light is indispensable for producing vitamin D in our food or in our own skins. UV light can also be used for the treatment of infections, disinfecting water, and it can help to control the growth of molds and fungi which can damage health. The luminous tube for this purpose, for the other types of light it can produce, for its rebuildability and potential for long life should be considered as a must have light source. The following are links to luminous "neon" tube resources that I have managed to collect.



- <http://www.electrobits.com/>
- <http://www.signweb.com/tecnolux/>
- <http://www.transco-neon.com/>
- <http://www.ventextech.com/>
- <http://www.tubelite.com/>

Offered by [Steve](#)

The gas pressure in a luminous tube, for example, is usually between 3 and 20 mm. The larger the diameter of tubing used the lower is the pressure required. To obtain mercury vapor, therefore, it is necessary to insert liquid mercury in the tube.

Offered by [Mike](#).



Troubled Times



Florescent

Florescent lighting is close to the efficiency of LED lighting at much lower cost. Over the past few years I have been attempting to use the Home Depot's 12 volt battery operated (8 AA cell) florescent light (sells for about \$10) and adapting it to work with 12 volt battery source. This is done by soldering a wire to each of the battery terminals and running this to a 12 volt battery. The bottom line is it doesn't work for very long. Any voltage approaching charging voltage of about 14.5 volts will burn out the unit in short order. Turn on charging generator with the light on and the unit is typically toasted.

I have now found a much more cost effective solution. It is a simple unit of an 8 watt florescent tube inside a plastic tube for protection, circuitry to create the proper voltage to light the tube, 14 ft of wire leads, and clip leads to attach to 12 volts. It is designed to work on 12 volts while the battery is charging. There are several places this 12V work light can be purchased at also. Search for "chil298". It currently can be found for:

\$3.33 at http://www.mattstools.com/product_info.php?products_id=541

I purchased my units locally for \$2.60 at a whole sale tool place. I found the unit to use about 3.5 watts when new at 13 volts. After one month of continuous use at 13.1 volts, it draws a maximum of about 4.8 watts to 6.5 watts. At 6.25 volts it easily starts, runs, and uses between 1.9 watts to 3.6 Watts. I added a simple on-off switch in series and it becomes a highly practical low wattage, cost effective, survival task light for your base camp. I recommend stocking up on many of these units for your survival site. A typical 12 volt screw in florescent bulb is of the order of \$20 or more.

Doing more testing of this cost effective 8 watt 12 Volt florescent light, I have found that a fully assembled light running full time at 13.1 Volts DC will last about 1,050 hrs. If one pulls the printed circuit board with the heat sink transistor half out into the open air so it gets better cooling then the unit lasts about 6, 400 hours. The rubbery end will easily slide off and one can gently stretch the wires so that the printed circuit board is half exposed to the cooling air. I let it sit like that for months. The unit then lasted about 6 times longer. To expose the PC board to more air becomes practical if the unit is mounted to some survival structure like a wall or ceiling.

The average wattage used over the time frame was 5.63 watts for the light with the enclosed PC heat sink and 5.44 watts for the light with the half exposed to air cooled heat sink. There is a tendency for the unit to draw a bit more wattage with time and put out less light than when new. This is normal and expected with all fluorescent lighting. I also noted that the in the end the solder melted on the PC board and one of the lead wires came loose when these units finally stopped working. In other words the PC board got so hot the lead wire popped off. I temporally reconnected it and the unit did not light. I suspect the bulb may still have some life to it but the PC board to be toasted. I also believe if one slides the bulb in the tube a bit and exposes more of the PC board that possibly even longer life may be possible.

Offered by [Mike](#).



Troubled Times



Quantum Devices

Here's the scoop on Quantum Devices and what they have currently as of 1998. It's a solid state lighting system with 200 LED's, 10% of which are blue light. The system is designed for research. There are tons of bells and whistles that allow you to modify red and blue lighting for experiments. Cost is \$3,000 for the power supply and \$995 for each module. The module with 400 micromuls of light covers about 4 square feet. My questioning was along the lines of take the bells and whistles out, and do we have a reasonably priced item here? I didn't get a really good answer other than it would depend on quantity and they haven't established "a commercial market".

There is no question in my mind that this is the wave of the future and these guys are on to the holy grail for our purposes. What they lack is the KISS (Keep it simple stupid) philosophy. They are talking to too many scientists and not enough normal people. If they can do a simple module that plugs in to the wall (the thing only uses 35 watts), and sell it for \$100, then they will have something that we can use. Right now they are paying \$1 per LED (according to them) and there are 200 LED's in one unit and that's a significant part of their cost structure issue. **These led units will last at least 15 years and that's a worse case scenario!!!** Beats the hell out of halide! Some changes in cost structure and marketing are needed for this thing to succeed for you and me. There is a [Chamber](#) using their device for just \$15,000 (aaagh).

[Quantum Devices](#) are located in a small town about 50 miles west of Madison. Their primary customer focus recently has been in the medical community for their lighting devices (surgical instruments). I supplied quite a bit on them to this listserve based on the growing study recently done. As I stated in that study, their current product is \$3000 for approximately 9 square feet of coverage - way too expensive. Quantum was very concerned about heat, so they have a fan in each unit that alleviates the heat, making it possible for the LED's to be virtually on top of a seed. They would be able to produce a product for about \$500 (economies of scale) if there were orders for production of 1000 units or more.

Offered by [John](#).



Troubled Times



Delta Light

I talked with Bill Mack of [Delta](#) light. He's a real guru when it comes to LED lights. I mentioned I would like to have some kind of grow light. He is looking into something like a 360 LED light in the \$400 range. I will be staying in touch with him on this project. Most studies show that 90% red, 10% blue is pretty optimal for plant growth. Bill mentioned that the colored LEDs will put out more light than the white LEDs for the same amount of energy. Delta light can be reached at:

Delta Light

P.O. Box 202223

Minneapolis, Minnesota 55420

email: deltalight77@hotmail.com

612-980-6503

Bill Mack at Delta Lights has a catalog through which he sells AC and DC LED lighting products. He has good prices and you can email him for a catalog if you are interested. My discussions with him have focused on persuading him to design a reasonably priced alternative, which he seems receptive. Of course, he is looking for a return on his investment. I will certainly be buying something once a final design is agreed upon, hopefully others will too, not only for their needs, but also to get a better price for all if more of them are sold. Hopefully the discussions and input from this list will help in designing a workable solution that we all can use. His response is below.

Offered by [Steve](#).

The reason for the frequency is two-fold: 1) the higher frequency is used to provide continuously variable dimming of the LEDs (from 1-99%). That is the dimmer control. A separate control would modulate the output at a lower frequency should the researcher decide he would need that function. Separate RED and BLUE LED dimmer controls provide for user-controlled optimum brightness (92% RED and 8% BLUE) but it is true that unless the user has some way to measure individual color intensity it's just "by guess and by golly!" The propose boards will be around 6" X 6" and yes, they will have an additional connection on them for "daisy chaining" to the next board. The system will be built on the concept of running on 12V DC. If one wants to run them off 115V AC (USA), or 230V AC (Europe) then the user buys himself an appropriate off-the-shelf power supply. ... I greatly hesitate to design these arrays with a running voltage over 12VDC because of safety sake! I don't want to shock anyone!! I will be manufacturing arrays with both fixed output (cheapest) and variable output (versatile) options.

Bill Mack

DeltaLight77@hotmail.com



Troubled Times



NASA

Here is an email I got back when trying to buy NASA's LED snaplites. For my own amusement, I figured it didn't hurt to try. I'm sure his center director is *very* interested in the project for obvious reasons.

Offered by [Steve](#).

*From: "Yorio-1, Neil", INTERNET:Neil.Yorio-1@pp.ksc.nasa.gov
To: "'Steve Ferguson"', steveferguson
Date: 1/19/99 12:54 PM
RE: RE: LED lighting details*

From: Steve [SMTP:steveferguson@compuserve.com]
Sent: Wednesday, January 13, 1999 1:16 PM
To: neil yorio
Subject: LED lighting details

>Dear Neil,

>I've been looking at the web pages concerning plant growth with LED
>lighting and have a couple of questions. Many of the hydroponics books I
>have been reading report lighting needs in either lumens or foot candles
>(lettuce needing 2000 lum, fruiting and flowering plants needing 4-6000
>lumens etc.), how does this relate or translate to umol measurements?

A footcandle is one lumen per square foot. A Lux is one lumen per square meter. So depending on your lamp type, you can convert lux to umol. For example, a cool white fluorescent lamp has 74 lux per umol, sunlight has 54 lux per umol (these examples are for PAR; 400-700 nm). The reference for this is Thimijan and Heins (1983) HortScience 18(6):818-822.

>Quantum Devices QBeam, Snap-Lite, and Ceres 2010 products seem to be
>excellent products, but are tremendously expensive, even considering the
>high cost of LEDs, do you know any other sources for LED grow lights?

We have only used LEDs purchased from Quantum Devices. Snaplite are made by Quantum Devices and CERES uses SnapLites. I don't know about Q Beam.

>Have you done any studies on the maximum spacing of LEDs where you still
>get a good growth rate?

No, we used lamp arrays that were custom built by some engineers at Ames. Spacing was never an issue in our studies as long as the distribution and intensity were OK.

>I have been trying to work with Delta light in developing a reasonably
>affordable LED grow light system that is more affordable. Do you have
>any other studies or info available on LED lighting and results not
>on the web pages that I can get hold of?

I don't know of any other information available than the studies we did (or what you can find in the

bibliography contained in our published papers), but if you contact Quantum Devices, they should be able to provide you a list of research done with LEDs. They hold the patent on using red LEDs for plant growth. Also, good luck making an affordable LED array.

- >Is there anyplace I can get some of the superdwarf wheat seed to
- >experiment with mentioned on the web page? Does it have a good yield
- >compared to regular wheat? Is it hybrid-ized to the point of future
- >yields not having the same characteristics of the parent crop?

Contact Dr. Bruce Bugbee at Utah State University. He is our source for the seed. They have a web site and you should be able to get to him that way.

- >I appreciate any help you could give. I
- >would be happy to freely share any results I come up with if you are
- >interested.

>Thanks, Steve

I don't think we can sell them. They were pretty expensive and we purchased them with money provided by our center director. He has an interest in what we are doing. This project will likely be for a long while, and the individual Snap Lites we are using have different wavelengths of red (i.e. an entire array of 660, 670, 680, 690, 700, and 720 nm) with blue LEDs mixed in. The older discrete type arrays are already being used by some other researchers within our group (and some collaborators) to do other investigations. So, at least at this moment, they are all gobbled up.

Neil

- >From: Steve
- >Sent: Wednesday, January 20, 1999 3:44 PM
- >To: Yorio-1, Neil
- >Subject: RE: LED lighting details

>Dear Neil,

- >I have another question. What do you do with the Quantum Device's
- >Snaplites when the LED project is over? Do you ever sell them? I would
- >be interested if they are for sale.

>Thanks, Steve



Troubled Times



Battery Banks

In regard to an optimal aftertime hydroponics setup, I've recently been toying with the idea of hooking up an array of windmills directly to a bank of LEDs. This way, we could skip the charging of batteries for this important use of electricity. Batteries have many problems: they're way too expensive, charging them wastes energy, they're difficult to maintain, and they have a relatively short lifespan. In my opinion, keeping a bank of expensive batteries is not a solution for growing plants in 20+ years of gloom. Furthermore, skipping the batteries makes the system less complex and less prone to failure. So here's what I'm thinking, and by the way, I'm not too familiar with the stuff, so please correct me where I'm wrong.

Say you have a bank of LED's that require 1amp at 12volts for an optimal lifespan of about 11 years. First you would hook up the windmill output to a regulator(?) to get your clean 12volts. then you would hook it up to a device that would take any current over 1amp, and direct it to an excess load (ie water heater, battery bank, etc). This would theoretically run the LEDs at their optimal level. And I'd imagine that when the output current is *less* than 1 amp, the LEDs would just be dimmer. But would not be damaged. This way, light output would be directly related to wind-speed. So is this setup even possible? What are the problems with such a setup? Can anyone with LED experience approximate the number of windmills required to run such a setup?

Offered by [Gabe](#).

Power is a problem I am yet to consider in depth, however, you may find your plants sitting in the dark if the wind stops blowing. To rule out batteries, I'd guess you may have to consider multiple concurrent power generationsources. A water turbine ala the [Rainbow Power Company](#) is my personal favorite at the moment, but this requires you have a continuous flow of water nearby. My uncle has configured a solar and wind power generation set-up on his plantation and used 2 heavy duty truck batteries (24 V I think) to store his power. He then stepped that down or up dependent on the respective circuit requirements. He enjoys an uninterrupted power supply, running electric lights, TV and video, washing machine, refrigerator, tools and other electrical things. Not all at once though, he is forced to manually manage the loading. It is worth noting that this has been operational for about 6 - 8 years and he has endured multiple cyclones with this configuration. I haven't heard him complain about replacing components yet, but as I say, I will be quizzing him further.

Offered by [Gino](#).



Troubled Times



Flashlights

Keep your eyes open for LED Flashlights. They should become more and more commonly available as we approach the PS. 100,000 hr bulb life is more than 11 years running 24/day 7 days/week. Battery life is greatly extended due to bulb efficiency. Some examples of what is currently available are:

- Photon [Micro-Light](#) key chain flashlight - The brightest for its size personal flashlight! Shines brightly for 124 hours with one battery.
- How to convert an existing flash light to work with a Red super bright [Radio Shack](#) LED. AA Battery lasts 20 times longer. Cost \$3.00.
- Comtrad industries has an **Eternalight** pocket flashlight that lasts 700 hrs using 3 AA batteries. Has various modes of operation. Cost is a bit high \$59.95. Call 800-704-1211.
- From LED Lites, 100,000 - Hour LED Flashlights, Electronic Strobes and Replacement Bulbs

I am now finding more and more LED Flash Lights at dollar or 99 cent stores. Keep an eye out for these. One has an aluminum body with 9 LEDs and runs on 3 AAA cells. Another is the hand-pressing type with 2 LEDs and mercury batteries. Recharging time can be done to some extent at 1/10 the run time as long as the batteries are not run too far down. The batteries last about 22 hours with the light on full time. The mechanism is defiantly worth a dollar. Wal-Mart sells the same thing for about \$4.99.

Offered by [Mike](#).



Troubled Times



Wide Angle

Sanding the round head off to get wider angle: Taking a LED that produces most of its light in a 12 degree angle and sanding or grinding off the rounded head to a flat will produce a wide angle LED. If one leaves the scratches then the light energy output goes down about 25% of the original. However, if one paints the scratches with anything clear such as epoxy, glue, clear sprays, lacquer, rust-oleum clear top coat, this allows more of the light to go out the front. With scratches some of the light is reflected back and goes out the back. Getting rid of the scratches improves the overall forwarded light output to 125 percent over the round forward light energy readings. The 12 degree light spread changes to about 90-100 degree spread. The light intensity falling at a distance goes down about 11x. However, many times for close up tasks, lighting a wide angle is more usefully than a narrow. The biggest advantage is the change from spot to flood type lighting.

Light measurements: The LX-101 Lux meter from Electronix Express (1-800 972 2225) part no. 01LX101 for \$65.95 works well. Comparative measurements at a know distance say one foot will give comparative light intensities. This can be done in a black plastic bag to cut down light from other sources. If the LED is placed in close contact with the light meter then comparative light energy (total light) can be measured between light sources. If one measure the light say 6" or 12" away from the source then one is measuring light intensity. Both of these ways of measuring are good for determining the relative efficiency of the LED one to another.



Another more accurate way to measure total light output energy is to use a silicon photo cell inside a small black box with a hole the size of the LED in one side. The arrangement is such that the LED is held close but at a fixed distance directly in front of the photo cell. The Photo cell is hooked to a digital current meter to measure relative current flow thus translating to light energy.

MCD (mili-candela) is a measure of light intensity not total light energy. MCD is becoming more and more a sales point without understanding the misleading ramifications it presents. Light intensity is energy over a given unit of area. It only indicates how hot a spot of light one can engineer into the unit. In other words LEDs are being designed to produce more and more mcd and as a result have a hot smaller and smaller spot that is being measured. Many times the result is too narrow for common use.



LED viewing angle degrees: As the viewing angle for a LED decreases the MCD goes up. Theoretically if all of the light energy for a 120 degree LED were concentrated into a 12 degree angle then we get the ratio of the square of these numbers or 100 times more light intensity. Due to leakage into other directions one doesn't in practice see any where near this result. It turns out to be about a bit more than 10 times more light intensity at the smaller angle. Thus as a simple rough rule of thumb the intensity goes up as the angle goes down by a bit more than approximately the ratio of the two angles.

Offered by [Mike](#).



Troubled Times



Resistors

Way to determine best series resistor or the number of series connected x-mass tree bulbs. Hook up 3 white or 5 yellow LED's in series with a variable resistor adjust source voltage to 15-16 V DC. Use the highest voltage that will be seen when in operation (including charging). At this maximum voltage adjust the pot to give 20 ma current flow for each parallel combination of LEDs. The best range for the LED operation at 12.5 volts is 10 ma (white) or 15ma (yellow) current flow for each parallel combination of LEDs. Measure the resulting resistance and you have the best value to use for this circuit. Choose the next higher standard resistance value that can be found as available.

If using x-mass tree tungsten filament bulbs then start wiring in bulbs in series until the current maximum at maximum voltage is close to being as recommended (10-15 ma for white). When soldering the x-mass tree bulbs together in series the leads need to be sanded or cleaned and tinned with solder. They are thin and will break easily and are hard to tin. Another way is to continue to use the socket. In this case one solders in series the number of sockets needed. If this is done the contacts with the bulb can be expected to give trouble (make poor contact) with age and wet conditions.

Given a limited number of a given type of mini-x-mass tree bulbs, first find the cold resistance (measure a number of them in series and divide by that number to get bulb resistance) and the operating voltage then attempt to match it with my list (see how to drive LEDs write up). Look up the resulting current for the curve bending point as near to but below the design current. Chose a number of parallel series combinations that you think might work and test it. Next adjust the number of bulbs in series until 15-16 volts input gives the intended limiting current flow. If too many bulbs are needed then add more LEDs in parallel if the bulb glows too brightly or near operating voltage then drop the number of LEDs in parallel. In this way one can tune up the result to be a minimum number of x-mass tree bulbs being needed and maximize the life of the x-mass bulbs.

Offered by [Mike](#).



Troubled Times



Battery Pack

3 cell rechargeable battery packs: Not recommended to use this low a voltage with white LEDs. Its operating voltage is too close to battery voltage. One solid color LED and a series resistor (white 82 ohm or yellow 130 ohm) or x-mass tree bulb can work. However, current will change rapidly with voltage as the batteries discharge.

4 cell rechargeable battery packs: First choice is one series connected white LED and a series connected resistor (white 160 ohm or yellow 220 ohm) or x-mass tree bulbs (6 W-20) current limiter. LM317 current limiter circuit doesn't work because voltage is too low. The rechargeable cells could be Ni-mh or Ni-cad. Typical circuit follows.

8 cell rechargeable battery packs: First choice is two series connected white LEDs and a LM-317 (using $R=82$ ohm) current limiting circuit. Second choice is a resistor (320 ohm) or x-mass tree bulb (6 W-20) current limiter. The rechargeable cells could be Ni-mh or Ni-cad. If two sets of 2 series LEDs are connected in parallel then use a LM-317 (with $R=41$ ohm).

12 Volt lead-acid batteries: First choice for two parallel of three series connected white LEDs is to use a LM-317 with 62 ohm current limiting circuit. Second choice is a resistor (130 ohms) or x-mass tree bulb (3 series W-20) current limiter. First choice for seven parallel of three series connected white LEDs is to use a LM-317 with 15 ohm current limiting circuit. Second choice is a resistor (40 ohms) or x-mass tree bulb (4 series W-35) current limiter. 5 yellow LEDs is about equivalent to 3 white LEDs in terms of voltage drop thus the same driver circuit should work.

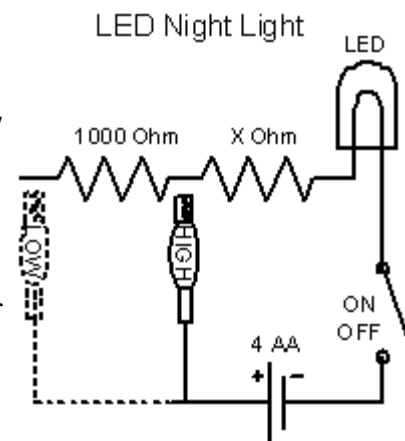

Offered by [Mike](#).



Troubled Times



LED Lifetime

The older LEDs that run at a slightly higher voltage will be fairly close to these measurements giving 5% to 10% lower currents for the same resistance.

For low power light (night light): Use a 500, 1000 or 2000 ohm resistor in series. The more LEDs you are diving use the lower resistance the fewer use the high resistance. It is really surprising the amount of light this low amount of power produces especially considering that the batteries will last approximately 10 times as long.

When wiring in parallel use LEDs from the same batch or same purchase. This helps insure they all run at the same voltage.

Always heat sink the leads between the LED and solder point when soldering. Use an alligator clip between the lead and the LED as a heat sink. The white LEDs are really sensitive to overheating.

LED lifetime: The red and solid color LEDs can run near 20 ma with about half light output after 100,000 hours. The white LEDs being more heat sensitive should be designed to run about 10 ma to get the better results. Running at 15 ma in my experience would be the absolute max to be used for temporary over voltage conditions. The 20 ma max as the manufactures recommend causes rapid degradation in the white LEDs. Always heat sink the leads of white LEDs when soldering them (especially true for the hotter type soldering irons)

The following shows how to hook up a LM-317 to limit the current flow. The battery source can range from 5 to 35 volts.

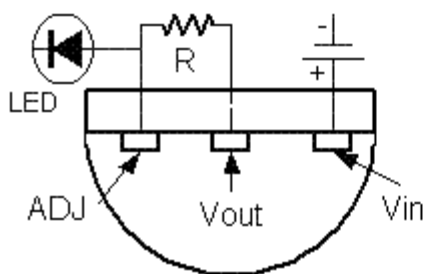

TO-92 Bottom View

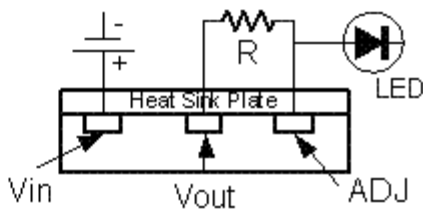

TO-220 Bottom View

This is what it looks like with the resistor in place.

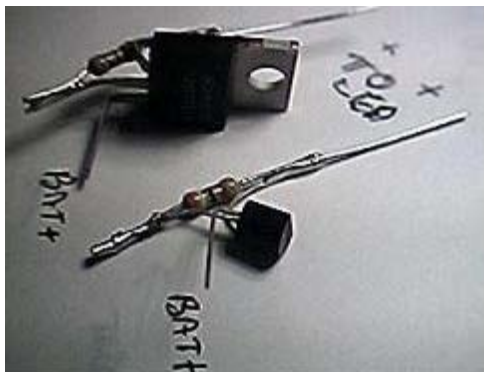

Good technical resource:

<http://www.intl-lighttech.com/library/calculators/>

<http://www.gizmology.net/LEDs.htm>

Theoretically a resistor needs to be added to each series combination of LEDs that will be put in parallel with others of like combinations. In practice this may not be necessary.

You built it. So if one series combination goes out in the ensuing years then you know how to repair it. Either cut the circuit open for the bad series combination and adjust over all current flow or solder in a new series set. Or replace the bad LED with preferably an LED that came from the same batch and has been ruining for about the same time frame. In other words repair when you have several series strings of the same types broken to get one working. Use one series string for spare parts for the others.

The way to tell the ones going bad is to lower the current down below .5 ma for the combination. Any that does not light or are low in light output or out of balance or are suspect. They could be going bad due to over heating either by soldering or by use.

12 volt lead acid batteries have a usable range of 11.5 volts to 15 volts when vigorously charging. The typical most common range of voltage encountered under normal use is 12 to 13 volts. Thus the LED should be designed to work between the extreme ranges with focus on the optimum desired current in the usual range of 12 to 13 volts.

Offered by [Mike](#).



Troubled Times



Dealing with Bugs

Adding a 1000 ohm resistor for a low setting gives 4 to 5 ma flow between 12 and 13 volts. Plan to use the amber for as much as you can. This will minimize bugs being attracted. White for task lights and red for distance at night. Amber, red and green are said to help protect against night blindness.

Bugs are attracted to UV LED light. One can try different shapes and types of pans of water. Put a little bit of soap in to cut down surface tension and helps keep the bug in the pan. At right is a low power way of killing bugs and mosquitoes. With power applied, it looks like the photo below.



Ultra Violet light can be used to spot urine and blood. It can be used to spot skin conditions where something (like fungus) is growing on it. It can be used to spot organic growing things in water. If enough power can be used it can purify water or air. A strong UV flash light or task light could be usefully in a primitive environment.

Offered by [Mike](#).



Troubled Times



Taillights

Count number of LEDs and divide by 3 then multiply by 20 ma (3-5mm) for white and 30 ma for Amber to get the maximum current that the unit should use. Design the circuit to draw about half this or 10-15 ma as a max per each LED. Thus for 9 LEDs draw should be no more than 30ma (white) to 45ma (amber) and, for 12 LEDs 40 ma (W) 60 ma (A), for 19 LEDs = 70 ma (W) 105ma (A). If you're chosen LED draws more than this amount at 14 Volts than a resistor in series will defiantly be needed. I have found that typically a 51 ohm ¼ watt will work in most cases. Another very good way to determine resistance needed is to measure the current at about 14 volts and adjust a series variable resistor such that the current ends up be about half of what was measured. Then measure the adjustable resistor and replace it with the nearest fixed resistance standard value.

Note: A word to the wise, I have not had good luck with running LEDs close to rated power. They quickly fade and lose brightness. As a rule of thumb always use more LEDs and design them to run half current where you can. As a result they will become more energy efficient at producing light and save power and end up lasting two to three times longer than at the rated current. The only exception to this rule is short term use emergency task flashlights. These can be run at .15 ma for a max rating of about 20 ma and .22 ma for a maxim rating of 30 ma. The thinking is the mechanics of the flashlight and or the batteries will ware out well before the LED. Use this where light weight or minimum components is desired.

The following table shows my experience with tail light bulbs. Any 12 volt bulb will work it doesn't have to be a one pin type. If two level of brightness bulbs are used they can be wired in parallel if needed to gain more light. Or one can use the lower light output terminal on multi-terminal bulbs if this gives plenty of light (it will defiantly save power).

LEDs No.	Draw ma	light output ma	Description
12	132	12.5	Tested at 13.6 volts
12	44	4.8	1156 white purchased 4 years ago.
12	8.5	.83	1156 white purchased 4 years ago after 51 ohm
			1156 white purchased 4 years ago after 510 ohm
12	34	4.5	1157 white purchased 4 years ago low side.
12	144	14.6	1157 white purchased 4 years ago high side.
12	42	4.4	1157 white purchased 4 years ago high side (51 ohm).
12	7.7	0.7	1157 white purchased 4 years ago high side (510 ohm).
12	94	14.5	1156 White JDM no resistor
12	49	9.2	1156 White JDM after 51 resistor
12	8.3	2.0	1156 White JDM after 510 resistor
19	143	7.0	1156 Amber no resistor
19	74	3.8	1156 Amber after 51 ohm resistor
19	14.4	0.5	1156 Amber after 510 ohm resistor
9	78	10.7	1156 White plastic cone no resistor
9	42	8.3	1156 White plastic cone after 51 ohm resistor
9	7.9	0.9	1156 White plastic cone after 510 ohm resistor

For a low setting use a 510 ohm resistor. It will use 10 times less current and power. The apparent light brightness between high and low is about one third or one half as bright. A little light at night can be used as nearly as good as a lot of light. Use only what is needed to save power.

Offered by [Mike](#).



Troubled Times



Construction

A clip is used in place of the switch.



Final result with high-low slide switch (center position is off):

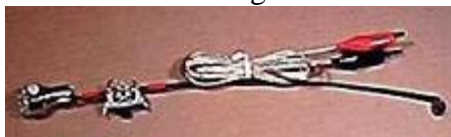

Close up on the wiring.



Construction Notes

Strip the insulation off number 12 or 14 solid wire for a 2 inch distance from one end of a 12 inch cut section of wire. Cut off a .25" section of the insulation and put it back on the end of the stripped bare wire. Slide it down so that about .25" of bare wire shows. Solder this to the base of the LED. Solder one side of the switch to the wire large copper wire. Solder the 18 gauge speaker wire copper color to the center of the 1156 bulb or to the brightest terminal of an 1157 or multi-terminal bulb. Solder the 51 ohm across the front terminals (ones closest to bulb) and solder the 510 ohm across the back terminals. Bend the bolt tabs up on each end of the switch to provide a flat area to push against. Make a loop in the end of the solid 14 gauge wire for fasting to the wall.

The slide switch can be purchased from <http://www.allelectronics.com/> Search for the part number "SSW-37" \$.25 to \$.33 depending on quantity.

LED Tail Light and Wall Mounting Fixture

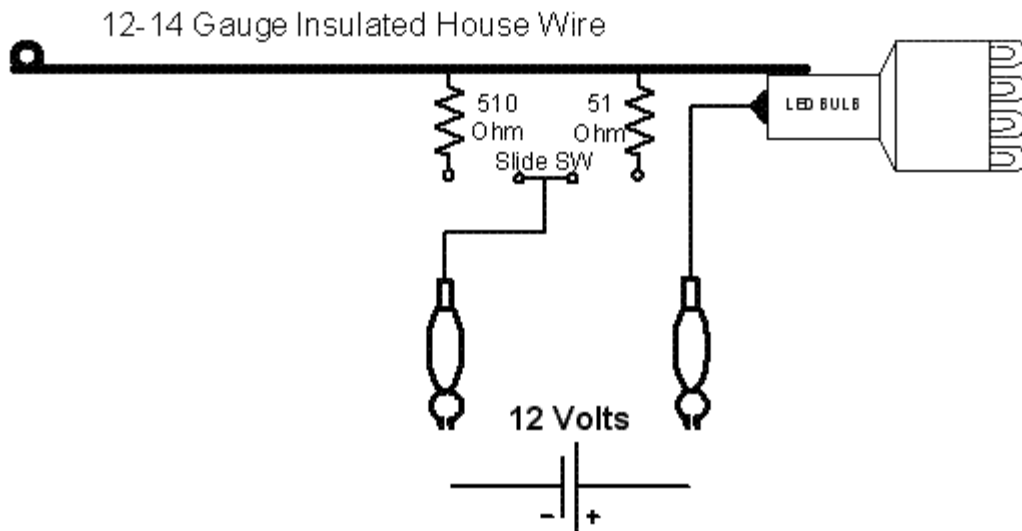

How the slide switch looks when wired. Note the tabs on the top of the switch are bent up to give a surface to push against.



Don't bother buying bulb sockets; instead solder directly to the bulb your power lead wire. I soldered a number 12 solid wire to the side of the base that is about 6" to 12" long that has a small loop bent into the other end. This is used to fasten it to a wall with a wood screw and washer. The stiff wire is intended to be bent to direct the light to the users needs. Ends up with a high and low setting depending on if the 510 ohm resistor is in or out of the circuit. In a pinch one can use a clip lead for the switch.

Offered by [Mike](#).



Troubled Times

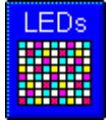

Old Sockets

Take apart the socket from a burnt out florescent bulb. Cut a circle of plastic or cardboard that will just fit into the shell. Solder 28 LED in series and place them around the perimeter of the circle and push in the circle of plastic to hold the LEDs.



The following is one way of how to wire a 1.1 Watt white LED light bulb that uses 115 Volt AC.

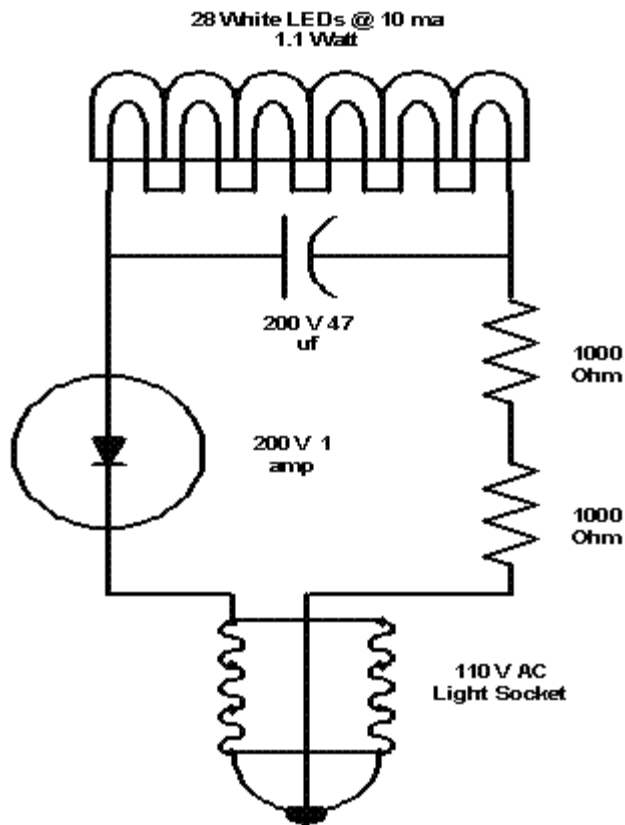

The following is an example of what can be done with LEDs held in place with silicon rubber (RTV Silicon Instant Gasket).

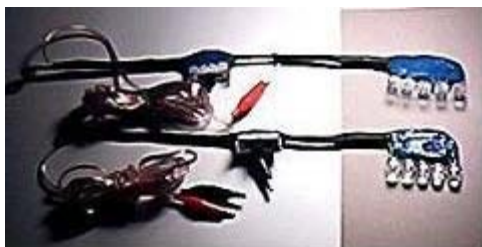

Different shapes for the end can be made for different purposes.



The pigtailed on the LEDs can be bent around the support wire as show below. This didn't work as well as using a PC board with holes in it. The LED leads have to get really hot during soldering to the number 12 wire. It is very easy to over heat the LED.



The use of a PC board with holes in it worked the best to organize and point the LEDs. Note that this rendition uses the LM-317 to limit current to 84 ma.

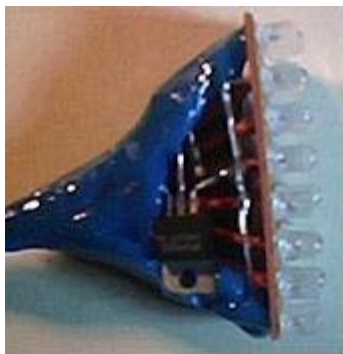

In this case sanding some of the LEDs flat and leaving some round to get the right light distribution.



Small stick on push to turn on battery operated LED lights can be found on the market these days. These were bought at a local store.



Or this can be made from an older tungsten filament version by taking it apart and replacing the bulb by several LEDs. This one has 3 LEDs a series resistor and runs on an external 12 Volt battery.



Offered by [Mike](#).



Troubled Times



Task Light

This task light is designed to be supported over the back of the neck. It uses 8 cells and runs at 55 ma on high and 18 ma on low. 2 sets of 4 parallel LEDs are in series.



Over the Shoulder LED Task Light

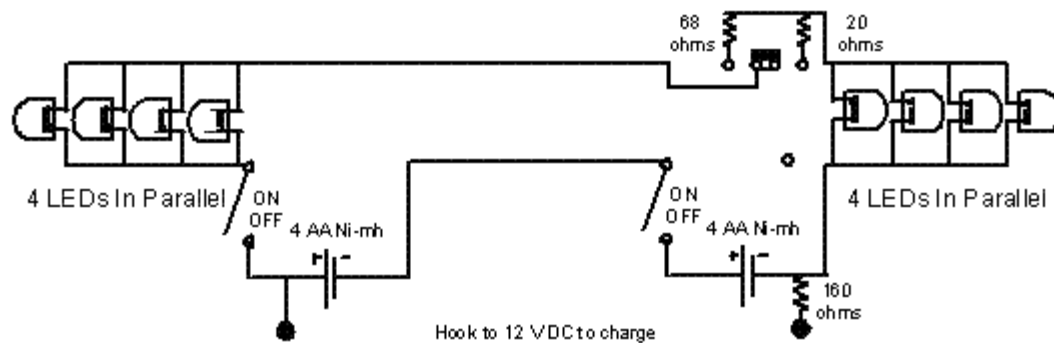

Silicon rubber was used to hold the LEDs and PC boards to the battery box. This unit as was built does not give enough flexibility to adjust the position of the LEDs and at the same time allow the battery packs to rest flat against the body. I recommend a 12 gauge short wire stand-off so that the LEDs direction can be adjusted. This next unit is a night light using minimal power. The battery packs shown in this report can be purchased from your local Radio Shack.

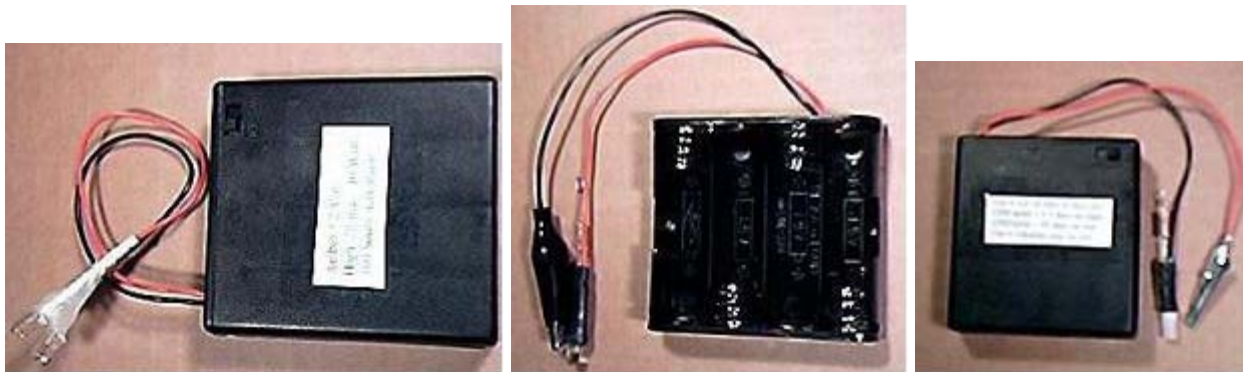

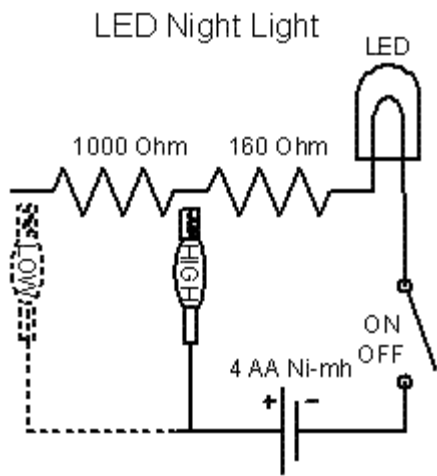

One charge of the cells will last (turned on full time) about 4 to 6 days on high and 1 to 2 months on low (1000 ohms) depending on the capacity of the batteries used.

Offered by [Mike](#).



Troubled Times



Clip-On

The clip is used to change from high to low setting. The switch on the battery case is used to turn on and off the unit. Other colors like amber are also useful to help keep bugs away at night.



This next picture shows a clip on a hat task light that works extremely well. It can last up to 24 hrs of on time at 90 ma. 6 LEDs running at about 75% power with 40 to 90 degrees LEDs work best for tasks with-in arms reach. Most commercial units have too small a spot size to be usefully at close range. They can be used when walking or longer distances. Most commercial units have too small a battery to last long. This unit has a wide angle of light with more intensity and bigger batteries.



Clip on LED Task Light

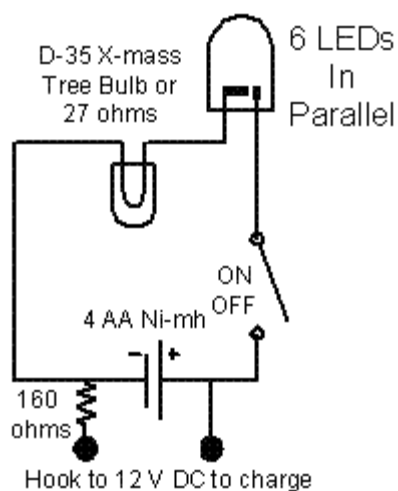

The clip was salvaged from a small clip-on LED "astro lite" bought at a 99 cent store. It was cut down to size with a hack saw. A pc board with holes in it was cut to size and 6 white LEDs were wired in parallel as per the diagram and picture above. 5 min epoxy was used to hold the LEDs in place. Silicon rubber gasket sealer was used to hold the resistor or x-mass tree bulb and charging leads in place.

This report should give one a good start on what can be made to assist survival in a primitive environment in terms of LED lighting.

Offered by [Mike](#).



Troubled Times



Wide Angle

Found a super flux 120 degree viewing angle white LED that works well for a clip on the hat task light. One can put two sets of 6 LEDs (120,000 mcd) on a PC board (lots of holes, no copper) from radio shack. The other color was yellow or amber with a narrow viewing angle, to used for outdoors. Other colors can be used. 6 white narrow viewing angle of say 12 to 20 degrees could just as well have been used (in this case use a 22 ohm for both white sets of 6 LEDs). The idea is one set of 6 can be used for distance and the other for close up work. Both sets are mounted on the same clip-on swivel joint. A plastic or metal clip with 12 to 14 gauge single strand wire glued to it and the PC board would also work. One bends the wire to aim the light.

The resistance was adjusted to run at about .09 amps (15 ma/LED) or to last about 28 hrs for a 2300 ma-hr NiCd rechargeable AA cells. This light was found to give plenty of light for close up (arm's reach) task lighting. I used 5-min epoxy to hold the resistors to the case and the PC board to the cap clamp swivel. Resistors were used in preference to X-mass tree bulbs to be small, unbreakable and trouble free. The batteries need to be checked occasionally while in use. Measure voltage of each cell before the next charging. If one finds a cell that goes to zero well before the others then replace it with one that stays charged. A bad cell can sometimes be zapped (provide a brief high charging current) into some kind of better existence.

Don't use new 1.6 volt disposable batteries (alkali) in this design. If this is done the over all current becomes about 130 ma for yellow and 133 ma for white. This means the white are running at 22 ma which is a bit high compared to 20 ma as a maximum for white LEDs. This could shorten the life of the LEDs. My experience is that these units produce more useful light than the 1 and 3 watt white LEDs on the market today. The wattage used by this unit is .09 times 5.3 volts or .48 watts or about half a watt. The white LEDs were purchased from Topbright on "ebay.com" for \$.34/each for 100 units. They were "5mm 20000mcd Super Flux White Led" with 120 degree viewing angle. Search for "super flux white led" to find it.



Clip on Super Flux LED Task Light

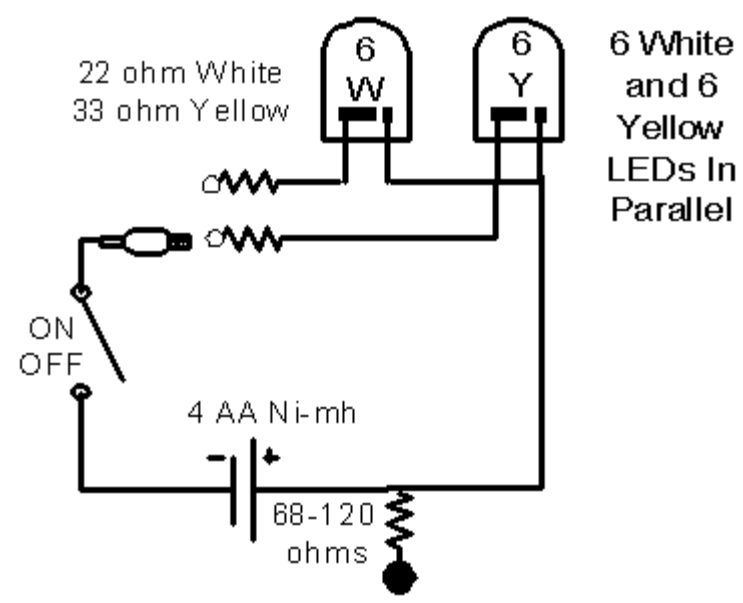

Hook Clip to -12 V DC turn on the switch and + Terminal to charge the 4 AA cells

Troubled Times



Computers

Some computer components, such as the monitor (screen) operate on 120V AC. But the main box (CPU) operates strictly off of 5V and 12V DC (technically +5V, -5V, + 12V, and -12V, but +5V and +12V take most of the power.) The 120V AC is converted to DC by a small switching power supply inside the box. One of the ideas I have played around with in the past is to build a computer power supply that runs off of a 12V car battery that bypasses the internal power supply of the computer. (This is more efficient than converting to 120VAC, then converting back to DC inside the box.) With more low-power technology coming onto the market such as flat screen LCD displays, eventually an entire computer system might be built using only 12VDC as input.

Where on should aim for the assumed voltage, switching power supplies today do have a bit of tolerance on the range of input voltage. The reason is that a switching supply converts high voltage to low voltage in little bursts, variances in the input voltage only change the rate at which these bursts need to occur. Of course you are right in that if the voltage is too high you'll exceed the rating of the parts and something will smoke. But there is still a good range, something like 85V - 150V AC. This is why during a brownout the monitor will go out but sometimes the computer will not. Even running strictly on 12V is not maintenance free. 12V batteries and light bulbs won't last forever either. Eventually the batteries will wear our and the bulbs will burn out. Then what? Perhaps we could grow our own batteries (certain mixtures of foods such as potatoes and lemons can form the basis for batteries), although this won't yield much power.

Offered by [Michael S.](#)



Troubled Times



Modify for DC

Many small appliances are designed to run on 120 V AC. Inside the computer, the 120 V AC is converted back to DC, giving voltages of +/-12 and +5. It is terribly inefficient to convert 12 V DC to 120 V AC, then back again. It makes much more sense to use a bank of 6 V batteries (or 12 V batteries with regulators) to derive the required voltages and wire them directly into the computer (or other appliance). For other appliances, this voltage will typically be 6, 9, or 12 volts. While you're stocking up on batteries, run down to your local electronics outlet and stock up on voltage regulators. Virtually any device that runs on 5 V DC will work fine on a 6 V battery. Alternatively, if the level is critical, a diode or two in series with the power supply will drop a nearly a volt each, leaving a usable voltage level applied to the appliance.

Offered by [Morgan](#).

All PC's are in fact DC. They run off a stabilized supply transformed from AC to DC. You should be able to connect a DC supply directly to the 12/9/5 Volt input power supply on the motherboard with little modification. Hard drives, CD's, floppies and monitors could prove problematic depending on type and input voltage, but on the whole they are transformed from AC to DC via internal transformers. This should also apply to most modern electronic equipment available today, however maintaining sufficient current on the heavier amperage devices is another problem.

Offered by [Brian](#).

Although I'm not 100% sure, I'd imagine that most motherboards utilize DC. It is the computer's power supply that converts AC to DC. Instead of looking for a DC computer package from a big suppliers like dell, I'd look for DC power supplies that can fit any machine. Here's a [Resource](#) for you to start with. If you've ever installed an add-on card in your computer, installing a new power supply should not be too difficult. Screw it in place, affix power switch, attach special cable to motherboard, and attach four pronged cables to any devices that need power (CD-ROM, hard-drive, floppy, etc.).

Offered by [Gabe](#).



Troubled Times



UPS

I have tried to search the web for any stationary PCs that can be driven directly on DC without luck. Suppliers like Dell, Compaq etc. do not have any DC models to my knowledge. I think there has been some articles in *Home Power* on converting off-the-shelf equipment to DC, but I was interested in any equipment that can be bought ready-made for DC for post-pole shift usage. Any ideas?

Offered by [Jan](#).

UPSs are an uninterruptable power supply you plug into the wall and then plug your PC into. Some of you may have one, I know I do. What it does is to condition the power and in the event of power failure it continues to run your PC while the electricity is off for a short while. Take the lid off though and you will see a small sealed lead-acid battery of the 12 volt type. Now just imagine how much longer it would run if you connected the leads on the tiny battery to an auto battery. Instant power for your PC with no mains available. If you haven't got one, go to your next local computer fair and buy a broken one (its normally the battery that's dead and you are going to connect it to a big one anyway) and if grid power is available all it will do is charge the battery back up. Oh yes, it doesn't have to be a PC that it powers, at about 350 watts that's a lot of fluorescent tubes!

Offered by [Ian](#).

If you really want to use 12 volt electricity to directly power your PC then all you have to do is pull out the power supply and wire a voltage divider to supply the various voltages to the computer. You will still need to supply AC to your monitor unless you use a LCD or PLASMA display, or if you go with a very expensive military DC CRT which will require interfacing to your computer. remember that the only reason modern personal computers are so affordable is that they are mass produced, when you begin using non mass produced items the price will skyrocket. There is an issue of *Mother Earth News* (I think) that had a very affordable home built UPS system that could easily become a more permanent solution to powering a computer system post-pole shift.

Offered by [Ray](#).



Wire Sizes and Maximum Length Determination

(7/5/2007)

Wire sizes become important at low voltages. At 12 volts DC a loss of more than 10% in voltage across the length of the wire can mean the difference between the inverter running or not running. The currents can get high and any voltage drop becomes significant. In general at 12 Volts DC one should run the inverter close to the battery and then pipe the 120 Volts AC to the point of use on smaller wire.

The general rule is at low voltages pay attention to voltage drop and at high voltages pay attention to maximum current carrying capacity for the size of wire.

Properly sized wire can make the difference between inadequate and full charging of a battery system, between dim and bright lights, and between feeble and full performance of tools and appliances. Designers of low voltage power circuits are often unaware of the implications of voltage drop and wire size. In conventional home electrical systems (120/240 volts ac), wire is sized primarily for safe amperage carrying capacity (ampacity). The overriding concern is fire safety.

In low voltage systems (12, 24, 48VDC) the overriding concern is power loss. Wire must not be sized merely for the ampacity, because there is less tolerance for voltage drop (except for very short runs). For example, a 1V drop from 12V causes 10 times the power loss of 1V drop from 120V.

Use the following charts as your primary tool in solving wire sizing problems.

Determining tolerable voltage drop for various electrical loads

A general rule is to size the wire for approximately 2 or 3% drop at typical load. When that turns out to be very expensive, consider some of the following advice. Different electrical circuits have different tolerances for voltage drop.

DC TO AC INVERTERS: Plan for 3 to 5% voltage drop. In a push to shove situation one can use up to a 10% voltage drop as a maximum.

LIGHTING CIRCUITS, INCANDESCENT AND QUARTZ HALOGEN (QH): Don't cheat on these! A 5% voltage drop causes an approximate 10% loss in light output. This is because the bulb not only receives less power, but the cooler filament drops from white-hot towards red-hot, emitting much less visible light.

LIGHTING CIRCUITS, FLUORESCENT: Voltage drop causes a nearly proportional drop in light output. A 10% drop in voltage is usually the max. Fluorescents use 1/2 to 1/3 the current of incandescent or QH bulbs for the same light output, so they can use smaller wire.

DC MOTORS operate at 10-50% higher efficiencies than AC motors, and eliminate the costs and losses associated with inverters. DC motors do NOT have excessive power surge demands when starting, unlike AC induction motors. Voltage drop during the starting surge simply results in a "soft start".

AC INDUCTION MOTORS are commonly found in large power tools, appliances and

Wire Sizes and Maximum Length Determination

(7/5/2007)

well pumps. They exhibit very high surge demands when starting. Significant voltage drop in these circuits may cause failure to start and possible motor damage. Follow the National Electrical Code. In the case of a well pump, follow the manufacturer's instructions.

MOST CHARGING CIRCUITS are critical because voltage drop can cause a disproportionate loss of charge current. To charge a battery, a generating device must apply a higher voltage than already exists within the battery. A voltage drop greater than 5% will reduce this necessary voltage difference, and can reduce charge current to the battery by a much greater percentage.

WIND GENERATOR CIRCUITS: At most locations, a wind generator produces its full rated current only during occasional windstorms or gusts. If wire sized for low loss is large and very expensive, you may consider sizing for a voltage drop as high as 10% at the rated current. That loss will only occur occasionally, when energy is most abundant. Consult the wind system's instruction manual.

ALUMINUM WIRE may be more economical than copper for some main lines. Power companies use it because it is cheaper than copper and lighter in weight, even though a larger size must be used. It is safe when installed to code with AL-rated terminals. You may wish to consider it for long, expensive runs of #2 or larger. The cost difference fluctuates with the metals market. It is stiff and hard to bend, and not rated for submersible pumps.

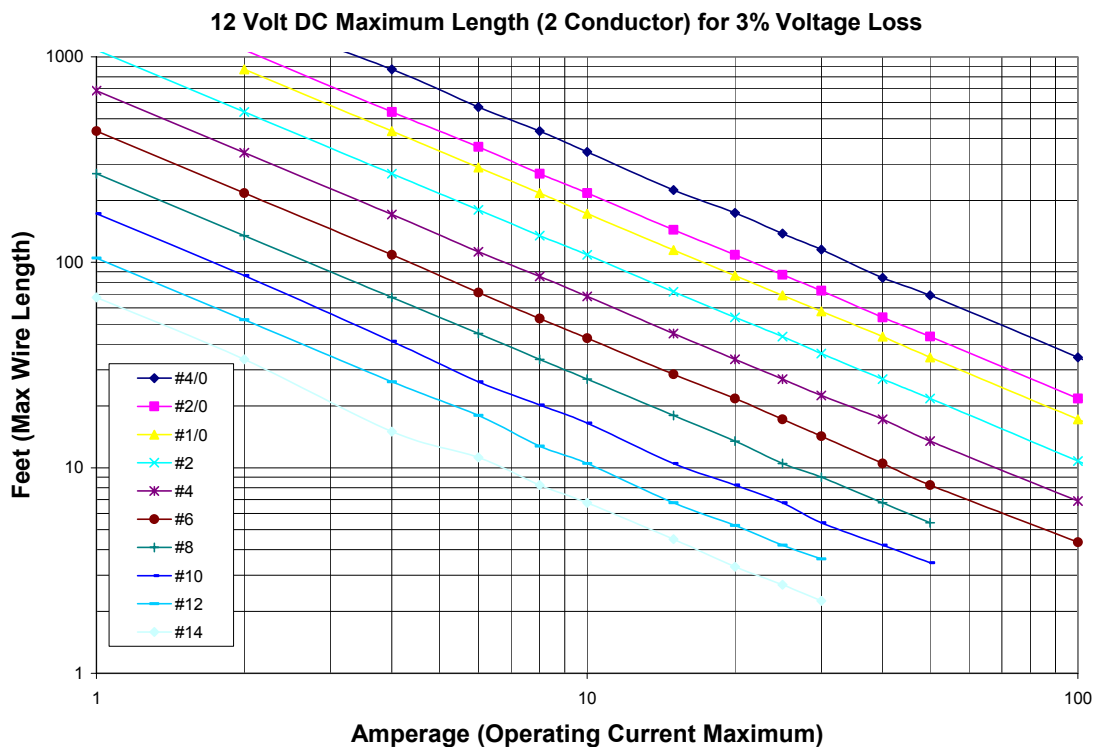

Wire Sizes and Maximum Length Determination

(7/5/2007)

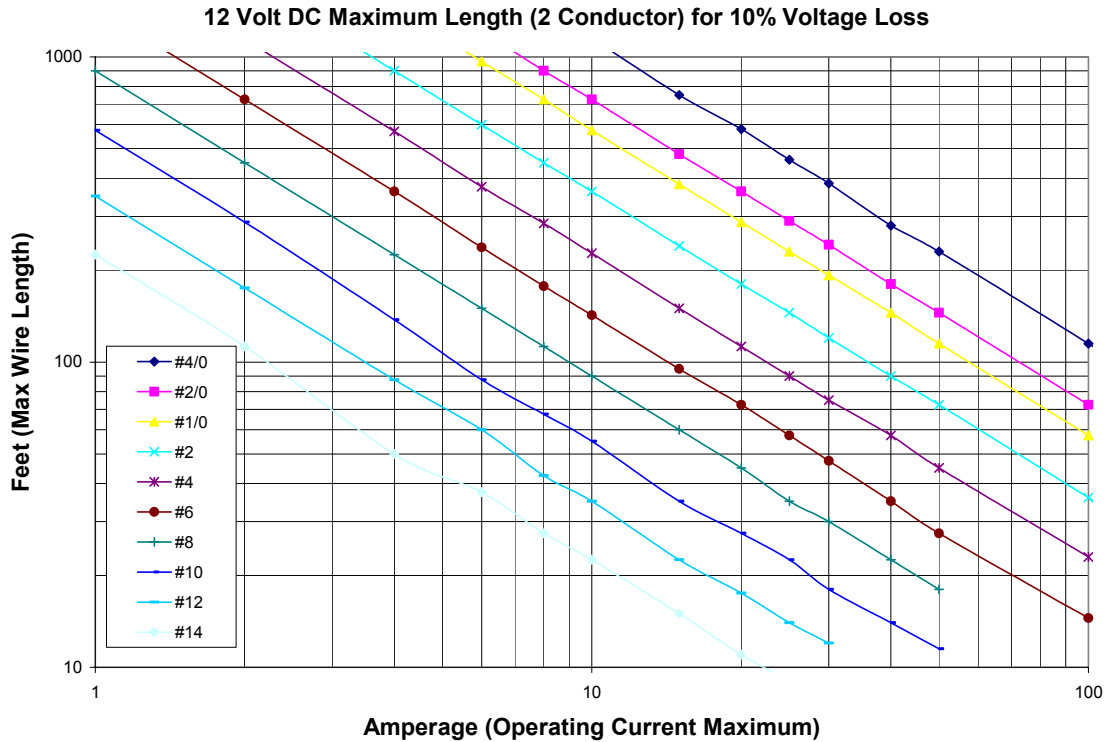

12 Volt 2% Wire Loss Chart

Maximum distance one-way in feet of various gauge two conductor copper wire from power source to load for 2% voltage drop in a 12 volt system. You can go twice the distance where a 4% loss is acceptable. A 4 to 5% loss is acceptable between batteries and lighting circuits in most cases. Multiply distances by 2 for 24 volts and by 4 for 48 volts.

2% Voltage Drop Chart										
Amps	#14	#12	#10	#8	#6	#4	#2	#1/0	#2/0	#4/0
1	45	70	115	180	290	456	720	.	.	.
2	22.5	35	57.5	90	145	228	360	580	720	1060
4	10	17.5	27.5	45	72.5	114	180	290	360	580
6	7.5	12	17.5	30	47.5	75	120	193	243	380
8	5.5	8.5	13.5	22.5	35.5	57	90	145	180	290
10	4.5	7	11	18	28.5	45.5	72.5	115	145	230
15	3	4.5	7	12	19	30	48	76.5	96	150
20	2	3.5	5.5	9	14.5	22.5	36	57.5	72.5	116
25	1.8	2.8	4.5	7	11.5	18	29	46	58	92
30	1.5	2.4	3.5	6	9.5	15	24	38.5	48.5	77
40	.	.	2.8	4.5	7	11.5	18	29	36	56
50	.	.	2.3	3.6	5.5	9	14.5	23	29	46
100	2.9	4.6	7.2	11.5	14.5	23
150	4.8	7.7	9.7	15

Wire Sizes and Maximum Length Determination

(7/5/2007)

Maximum Ampacities (Amperage Capacity) for Wire

Allowable ampacities of conductors (wires) in conduit, raceway, cable or directly buried, based on ambient temperature of 86° F (30° C). NEC allows rounding up cable ampacity to the next size standard fuse or breaker. Use this table for high voltages of 120 volts or higher.

Maximum Ampacity for Copper and Aluminum Wire				
Wire Size	Copper		Aluminum	
	167° F (75° C)	194° F (90° C)	167° F (75° C)	194° F (90° C)
*14	20	25		.
*12	25	30	20	25
*10	35	40	30	35
8	50	55	40	45
6	65	75	50	60
4	85	95	65	75
2	115	130	90	100
1	130	150	100	115
1/0	150	170	120	135
2/0	175	195	135	150
3/0	200	225	155	175
4/0	230	260	180	205

* The national electric code (NEC) specifies that the over current protection device not exceed 30A for 10 AGW wire, 20A for 12 AGW wire and 15A for 14 AWG wire.
<http://www.builditsolar.com/References/pvwiring.htm>

Quick Overview

As electric current flows through wire, there is a loss in voltage. This loss is referred to as IR voltage drop. Voltage (Drop) = Wire Resistance Times Amps of current ($E=IR$)

Calculating the voltage loss for a pair of wires gets a little complicated, so we have constructed a quick look up table for what size wire you will need for your application. The table below is for 12-volt ac or dc devices only. You just need to know the power in Watts (VA), or Amps and the table will show how far you can go in feet for any size wire pair listed. The table is based on a 10% loss of voltage on a pair of wires. This should work for most 12-volt devices. Checking the manufacturer's specifications, use the maximum watts or current and be sure the minimum operational voltage is 10v or below. The footage in the table is linear, a 20% loss would double the distance, or 5% would cut it in half.

The table calculations are based on the ohms of the wire at 70oF. If the wire temperature

Wire Sizes and Maximum Length Determination

(7/5/2007)

is raised to 130oF the voltage drop would increase by about 3%. The voltage drop calculations are also based on a conventional load.

The recommended maximum distances in feet for AC or DC are listed in the cell below the wire size.

POWER W (VA) /Amps	12V TABLE WIRE GAUGE									
	8awg	10awg	12awg	14awg	16awg	18awg	20awg	22awg	24awg	26awg
3W/.25A	3,733	2,396	1,508	947	595	376	234	146	93	59
4W/.33A	2,828	1,815	1,142	717	451	285	177	111	70	44
5W/.42A	2,222	1,426	898	564	354	224	139	87	55	35
10W/.83A	1,124	722	454	285	179	113	71	44	28	18
20W/1.67A	559	359	226	142	89	56	35	22	14	9
30W/2.50A	373	240	151	95	60	38	23	15	N/A	N/A
40W/3.33A	280	180	113	71	45	28	18	11	N/A	N/A
50W/4.17A	224	144	90	57	36	23	14	N/A	N/A	N/A
60W/5.00A	187	120	75	47	30	19	12	N/A	N/A	N/A
70W/5.83A	160	103	65	41	26	16	10	N/A	N/A	N/A
80W/6.67A	140	90	57	35	22	14	N/A	N/A	N/A	N/A
90W/7.50A	124	80	50	32	20	13	N/A	N/A	N/A	N/A
100W/8.33A	112	72	45	28	18	11	N/A	N/A	N/A	N/A
110W/9.17A	102	65	41	26	16	10	N/A	N/A	N/A	N/A
120W/10.00A	93	60	38	24	15	N/A	N/A	N/A	N/A	N/A

<http://www.securitypower.com/AN2Wire.html>

12 Volts – Wire Sizes (Gauge) 3 % Drop for Radios													
Total Wire Length in Feet													
		10	15	20	25	30	40	50	60	70	80	90	100
Amp	5	18	16	14	12	12	10	10	10	8	8	8	6
	10	14	12	10	10	10	8	6	6	6	6	4	4
	15	12	10	10	8	8	6	6	6	4	4	2	2
	20	10	10	8	6	6	6	4	4	2	2	2	2
	25	10	8	6	6	6	4	4	2	2	2	1	1
	30	10	8	6	6	4	4	2	2	1	1	0	0
	40	8	6	6	4	4	2	2	1	0	0	2/0	2/0
	50	6	6	4	4	2	2	1	0	2/0	2/0	3/0	3/0
	60	6	4	4	2	2	1	0	2/0	3/0	3/0	4/0	4/0
	70	6	4	2	2	1	0	2/0	3/0	3/0	4/0	4/0	
	80	6	4	2	2	1	0	3/0	3/0	4/0	4/0		
90	4	2	2	1	0	2/0	3/0	4/0	4/0				
100	4	2	2	1	0	2/0	3/0	4/0					

Wire Sizes and Maximum Length Determination

(7/5/2007)

12 Volts – Wire Sizes (Gauge) 10 % Drop for Lights													
Total Wire Length in Feet													
	10	15	20	25	30	40	50	60	70	80	90	100	
Amp	5	18	18	18	18	18	16	16	14	14	14	12	12
	10	18	18	16	16	14	14	12	12	10	10	10	10
	15	18	16	14	14	12	12	10	10	8	8	8	8
	20	16	14	14	12	12	10	10	8	8	8	6	6
	25	16	14	12	12	10	10	8	8	6	6	6	6
	30	14	12	12	10	10	8	8	6	6	6	6	4
	40	14	12	10	10	8	8	6	6	6	4	4	4
	50	12	10	10	8	8	6	6	4	4	4	2	2
	60	12	10	8	8	6	6	4	4	2	2	2	2
	70	10	8	8	6	6	6	4	2	2	2	2	1
	80	10	8	8	6	6	4	4	2	2	2	1	1
	90	10	8	6	6	6	4	2	2	2	1	1	0
	100	10	8	6	6	4	4	2	2	1	1	0	0
	150	8	8	4	4	2	2	1	0	0	2/0	2/0	2/0
200	6	6	4	4	2	1	2/0	2/0	2/0	4/0	4/0	4/0	

24 Volts – Wire Sizes (Gauge) 10 % Drop for Lights													
Total Wire Length in Feet													
	10	15	20	25	30	40	50	60	70	80	90	100	
Amp	5	18	18	18	18	18	18	18	18	16	16	16	16
	10	18	18	18	18	18	16	16	14	14	14	12	12
	15	18	18	18	16	16	14	14	12	12	12	10	10
	20	18	18	16	16	14	14	12	12	10	10	10	10
	25	18	16	16	14	14	12	12	10	10	10	8	8
	30	18	16	14	14	12	12	10	10	8	8	8	8
	40	16	14	14	12	12	10	10	8	8	8	6	6
	50	16	14	12	12	10	10	8	8	6	6	6	6
	60	14	12	12	10	10	8	8	6	6	6	6	4
	70	14	12	10	10	8	8	6	6	6	6	4	4
	80	14	12	10	10	8	8	6	6	6	4	4	4
	90	12	10	10	8	8	6	6	6	4	4	4	2
	100	12	10	10	8	8	6	6	4	4	4	2	2

Wire Sizes and Maximum Length Determination

(7/5/2007)

Universal Wire Sizing Chart A 2-Step Process

This chart works for any voltage or voltage drop, American (AWG) or metric (mm²) sizing. It applies to typical DC circuits and to some simple AC circuits (single-phase AC with resistive loads, not motor loads, power factor = 1.0, line reactance negligible).

Wire Size	Area mm ²	COPPER		ALUMINUM	
AWG		VDI	Ampacity	VDI	Ampacity
16	1.31	1	10	Not Recommended	
14	2.08	2	15		
12	3.31	3	20		
10	5.26	5	30		
8	8.37	8	55		
6	13.3	12	75		
4	21.1	20	95		
2	33.6	31	130	20	100
0	53.5	49	170	31	132
00	67.4	62	195	39	150
000	85.0	78	225	49	175
0000	107	99	260	62	205

STEP 1: Calculate the Following:

$$\text{VDI} = (\text{AMPS} \times \text{FEET}) / (\% \text{VOLT DROP} \times \text{VOLTAGE})$$

VDI = Voltage Drop Index (a reference number based on resistance of wire)
 FEET = ONE-WAY wiring distance (1 meter = 3.28 feet)
 %VOLT DROP = Your choice of acceptable voltage drop (example: use 3 for 3%)

STEP 2: Determine Appropriate Wire Size from Chart

Compare your calculated VDI with the VDI in the chart to determine the closest wire size. Amps must not exceed the AMPACITY indicated for the wire size.

Metric Size by cross-sectional area	COPPER (VDI x 1.1 = mm ²)	ALUMINUM (VDI x 1.7 = mm ²)
Available Sizes: 1 1.5 2.5 4 6 10 16 25 35 50 70 95 120 mm ²		
EXAMPLE: 20 Amp load at 24V over a distance of 100 feet with 3% max. voltage drop		

Wire Sizes and Maximum Length Determination

(7/5/2007)

$VDI = (20 \times 100) / (3 \times 24) = 27.78$	For copper wire, the nearest VDI=31. <i>This indicates #2 AWG wire or 35mm²</i>
---	---

NOTES: AWG=American Wire Gauge. Ampacity is based on the National Electrical Code (USA) for 30 degrees C (85 degrees F) ambient air temperature, for no more than three insulated conductors in raceway in free air of cable types AC, NM, NMC and SE; and conductor insulation types TA, TBS, SA, AVB, SIS, RHH, THHN and XHHW. For other conditions, refer to National Electric Code or an engineering handbook.

<http://howto.altenergystore.com/Reference-Materials/How-to-Size-Wiring-and-Cabling-for-Your-System/a62/>

The above formula results in:

Maximum feet for one wire running at Amp Capacity (ampacity)							
AWG	Ampacity	12V-3%	12V-10%	48V-3%	48V-10%	120V-3%	120V-10%
16	10	4	12	14	48	36	120
14	15	5	16	19	64	48	160
12	20	5	18	22	72	54	180
10	30	6	20	24	80	60	200
8	55	5	17	21	70	52	175
6	75	6	19	23	77	58	192
4	95	8	25	30	101	76	253
2	130	9	29	34	114	86	286
0	170	10	35	42	138	104	346
00	195	11	38	46	153	114	382
000	225	12	42	50	166	125	416
0000	260	14	46	55	183	137	457

Power Streams Table

AWG gauge	Diameter Inches	Diameter mm	Ohms per 1000 ft	Ohms per km	Maximum amps for chassis wiring	Maximum amps for power transmission
0000	0.4600	11.6840	0.0490	0.16072	380	302
000	0.4096	10.4038	0.0618	0.20270	328	239
00	0.3648	9.2659	0.0779	0.25551	283	190
0	0.3249	8.2525	0.0983	0.32242	245	150
1	0.2893	7.3482	0.1239	0.40639	211	119
2	0.2576	6.5430	0.1563	0.51266	181	94
3	0.2294	5.8268	0.1970	0.64616	158	75

Wire Sizes and Maximum Length Determination

(7/5/2007)

4	0.2043	5.1892	0.2485	0.81508	135	60
5	0.1819	4.6203	0.3133	1.02762	118	47
6	0.1620	4.1148	0.3951	1.29593	101	37
7	0.1443	3.6652	0.4982	1.63410	89	30
8	0.1285	3.2639	0.6282	2.06050	73	24
9	0.1144	2.9058	0.7921	2.59809	64	19
10	0.1019	2.5883	0.9989	3.27639	55	15
11	0.0907	2.3038	1.2600	4.13280	47	12
12	0.0808	2.0523	1.5880	5.20864	41	9.3
13	0.0720	1.8288	2.0030	6.56984	35	7.4
14	0.0641	1.6281	2.5250	8.28200	32	5.9
15	0.0571	1.4503	3.1840	10.4435	28	4.7
16	0.0508	1.2903	4.0160	13.1725	22	3.7
17	0.0453	1.1506	5.0640	16.6099	19	2.9
18	0.0403	1.0236	6.3850	20.9428	16	2.3
19	0.0359	0.9119	8.0510	26.4073	14	1.8
20	0.0320	0.8128	10.1500	33.2920	11	1.5
21	0.0285	0.7239	12.8000	41.9840	9	1.2
22	0.0254	0.6452	16.1400	52.9392	7	0.92
23	0.0226	0.5740	20.3600	66.7808	4.7	0.729
24	0.0201	0.5105	25.6700	84.1976	3.5	0.577
25	0.0179	0.4547	32.3700	106.174	2.7	0.457
26	0.0159	0.4039	40.8100	133.857	2.2	0.361
27	0.0142	0.3607	51.4700	168.822	1.70	0.288
28	0.0126	0.3200	64.9000	212.872	1.40	0.226
29	0.0113	0.2870	81.8300	268.402	1.20	0.182
30	0.0100	0.2540	103.2000	338.496	0.86	0.142
31	0.0089	0.2261	130.1000	426.728	0.70	0.113
32	0.0080	0.2032	164.1000	538.248	0.53	0.091
Metric 2.0	0.0079	0.2000	169.3900	555.610	0.51	0.088
33	0.0071	0.1803	206.9000	678.632	0.43	0.072
Metric 1.8	0.0071	0.1800	207.5000	680.550	0.43	0.072
34	0.0063	0.1600	260.9000	855.752	0.33	0.056
Metric 1.6	0.0063	0.1600	260.9000	855.752	0.33	0.056
35	0.0056	0.1422	329.0000	1079.12	0.27	0.044
Metric 1.4	0.0055	0.1400	339.0000	1114.00	0.26	0.043
36	0.0050	0.1270	414.8000	1360.00	0.21	0.035
Metric 1.25	0.0049	0.1250	428.2000	1404.00	0.20	0.034
37	0.0045	0.1143	523.1000	1715.00	0.17	0.0289
Metric 1.12	0.0044	0.1120	533.8000	1750.00	0.16	0.0277
38	0.0040	0.1016	659.6000	2163.00	0.13	0.0228
Metric 1	0.0039	0.1000	670.2000	2198.00	0.13	0.0225

Wire Sizes and Maximum Length Determination

(7/5/2007)

39	0.0035	0.0889	831.8000	2728.00	0.11	0.0175
40	0.0031	0.0787	1049.0000	3440.00	0.09	0.0137

http://www.powerstream.com/Wire_Size.htm

All extension-cord jackets are marked with a code that indicates (among other information) the American wire gauge (AWG) as well as the jacket material and its properties, according to standards established by the National Electrical Code.

Then there's the challenging of deciphering that odd code on the side of most of your extension cords.



In the picture above, The **AWG 12-3** is telling you the American Wire Gauge (AWG) is 12 and there are 3 wires inside. The SEOW means... well, see below:

- O:** Oil-resistant, usually synthetic-rubber jacket, more flexible in cold temperatures
- OO:** Oil-resistant synthetic-rubber jacket and inner-conductor insulation
- S:** Standard service (synthetic-rubber insulated, rated for 600v)
- SE:** Extra-hard usage, elastomer
- SEOW:** Oil-resistant and weather-resistant elastomer jacket, rated for 600v (photo above)
- SJ:** Service junior (synthetic-rubber insulated, rated for 300v)
- SJO:** Same as SJ but Neoprene, oil resist compound outer jacket, rated for 300v
- SJOW:** Oil-resistant and weather-resistant synthetic rubber, rated for 300v
- SJOOW:** Oil-resistant and weather-resistant synthetic rubber (jacket and conductor insulation), rated for 300v
- SJT:** Hard service thermoplastic pr rubber insulate conductors with overall plastic jacket, rated for 300v
- SJTOW:** Oil-resistant and weather-resistant thermoplastic, rated for 300v
- SJTW:** Thermoplastic-jacketed, weather-resistant, rated for 300v
- SO:** Extra hard service cord with oil resistant rubber jacket, 600v
- SOOW:** Same as SOW but with oil resistant rubber conductor insulation and suitable for outdoor use.
- SOW:** Rubber jacketed portable cord with oil and water resistant outer jacket
- SPT-1:** All rubber, parallel-jacketed, two-conductor light duty cord for pendant or portable use, rated for 300v
- SPT-2:** Same as SPT-1, but heavier construction, with or without third conductor for grounding purposes, rated for 300v
- SPT-3:** Same as SPT-2, but heavier construction for refrigerators or room air conditioners, rated for 300v
- ST:** Extra-hard usage, thermoplastic (PVC), 600v
- STO:** Same as ST but with oil resistant and thermoplastic outer jacket, 600v
- STOW:** Same as STO but with oil and water resistant thermoplastic outer jacket, 600v

Wire Sizes and Maximum Length Determination

(7/5/2007)

▪ **SV:** Vacuum cleaner cord, two or three conductor, rubber insulated, rubber jacket, 300v

▪ **SVO:** Same as SV except neoprene jacket, 300v

▪ **SVT:** Same as SV except all thermoplastic construction, 300v

▪ **SVTO:** Same as SVT except with oil resistant jacket, 300v

▪ **THHN:** 600v nylon jacketed building wire

▪ **THW:** Thermoplastic vinyl insulated building wire, moisture and heat resistant

▪ **THWN:** Same as THW but with nylon jacket

▪ **W:** Extra-hard usage, weather-resistant

<http://www.dot.ca.gov/hq/eqsc/QualityStandards/Electric/Electric-01.htm>